

**All you want to  
know about the  
BBC MICRO!**

# **THE MICRO USER**

Volume 1  
Number 10  
December 1983  
£1

**Drop in  
on the  
BBC Micro  
User Show**

**Westminster  
Exhibition  
Centre**

**December 8 to 11**

**Page graphics:  
6845 revealed**

**Beginners' guide to  
string handling**

**Three BBC chess  
packages reviewed**

## **PLUS LOTS OF LISTINGS:**

**Fly Santa's Saucer . . . meet the  
pixels on your Christmas tree . . .  
make your BBC Micro the star  
of your Christmas party . . . and  
pit your wits against the Phantoms  
of Tower Bridge**

**WIN**

**a Micronet  
modem and  
subscription in  
this month's  
contest**

**Another free  
issue inside!**

**electron  
11se**



# Software for the BBC micro

32K  
Chess



£8.95 incl.

Excellent use of the high-res graphics help to make this the most flexible chess game available. A choice of hundreds of different skill levels control the playing strength. This game has been continually updated over the past few years and this later version incorporates a host of new facilities, including the ability to: change the board and piece colours; replay a game, move by move; change levels whilst playing; ask the computer to suggest a move; force the computer to make a move at any time; save a game on tape or disc; blitz play within a time limit; mate in 2, 3 or 4 moves; castle and en passant.

Quite simply the best chess game available for the BBC Micro.

32K  
Android  
Attack



£8.95 incl

You are in the middle of a maze being chased by various androids, your only weapons being your hand laser and a quantity of land mines. These mines can be dropped at any point in the maze and later detonated under remote control. Beware of the "Smiley" master android and watch your oxygen levels — the lower the level the slower you move. Many different skill levels and a high score table.

"The graphics and colour in Android, are excellent and the game has an appeal which is unique . . . One of the best games to appear recently . . ." Your Computer.

32K  
Swarm

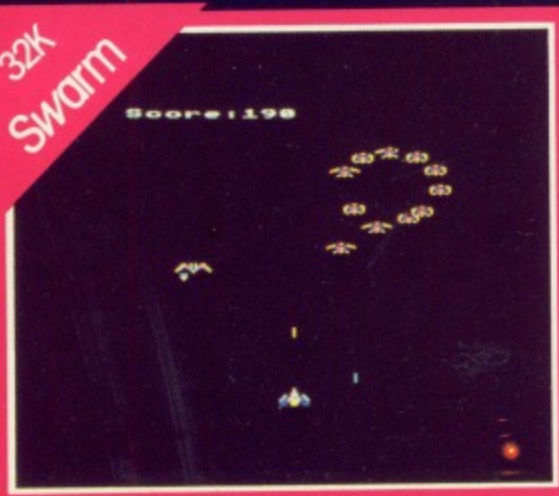

£8.95 incl.

A formation of attacking birds control the sky. Your aim is simply to destroy the birds, bombs, eggs that hatch into diving eagles, this action packed game features exceptionally smooth graphics and novel sound effects. Joystick or keyboard operation.

32K  
Draughts

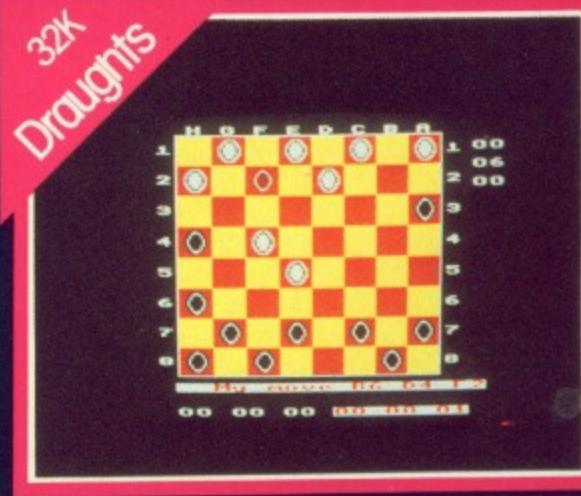

£8.95 incl.

From the same author as our best selling Chess program, this game incorporates many of the features of that program — various skill levels, save a game to tape, replay a stored game, etc. etc. A high resolution colour display (the user may change the colours) and an option to choose the rules of play make this game extremely flexible. Works with all Operating Systems.

32K  
Games  
Galore



£8.95 incl.

One cassette containing 4 arcade games.

**LOONY LANDER** — Controls the rockets of a lunar landing craft as it descends to the moon surface. Try to land in one of the three permissible landing spots.

**SPACE INVADERS** — A fast machine code implementation of this old favourite.

**FRUIT WORM** — Controlling the direction of the worm, the object of the game is to eat the fruit that is littered over the ground but not the vegetables. The more you eat, the longer you become.

**FRUIT MACHINE** — Good sound effects and realistic high resolution graphics make this the best "One arm bandit" stimulation around. This tape represents exceptional value for money as it contains 4 full feature games normally selling as separate tapes costing £7.95 each.

32K  
Logo 2



£11.50 incl.

One of our most popular programs to date. This is not a game, but an introduction to the LOGO graphics language that has become so popular in schools. It incorporates the 'turtle' graphics and many other features common to all LOGOS. Fascinating patterns or other graphics work can be built up very easily using the set of inbuilt commands. The command set can be extended by adding new 'words' to its vocabulary based on the existing set. Logo 2 can be used as a very simple graphics aid for young children, but it can incorporate more advanced ideas — defined procedures, sub-routines, loops and even recursive programming. Supplied with full documentation.

CASH OR ROYALTIES. We specialise in quality software for the BBC machine and can offer the best rates around. We are always interested in obtaining new programs to add to our range and offer either a cash payment for the outright purchase or alternatively pay a royalty on each one sold.

Computer  
Concepts

BARCLYCARD  
VISA

Access

16 Wayside, Chipperfield, Herts WD4 9JJ. Telephone (09277) 69727



- Single 100K drive £225
- Double 200K drive £399  
includes VAT and delivery to your door.

**NOW  
AVAILABLE  
AT  
W. H. SMITH**



## New! The AMS 3" disk drive.

**The neatest and best disk option ever.**

the eject button. A unique feature of the new disks is a mechanical tab which prevents overwriting of precious data. And of course, you can switch it back when necessary.

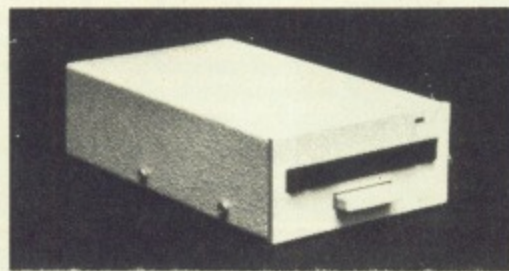

### Reliable and robust

The Hitachi boasts a brush-less direct drive motor, the best possible system for trouble free use. AMS-3 units simply run off the BBC power supply – they don't need their own supply and there's no need to worry about corrupt data.

The standard interface lets you use the disk drive with most other computers in tandem with 5 1/4" drives.

### High Speed Access

The disk drive provides a track-to-track access time of only 3mS, much faster than old fashioned drives.

The AMS disk drive works with all DFS and disk upgrade kits.

### Excellent Manual

Included with your drive will be an easily understood 80pp user guide, with full explanation of the BBC Disc Filing System (DFS).

### How to order

If there isn't a stockist near you – just fill in the coupon below, and we will send your order with our full no-quibble money-back guarantee or ring (0925) 62907 for 24 hour service.

Advanced Memory Systems Ltd,  
Woodside Technology Centre,  
Green Lane, Appleton,  
Warrington, Cheshire WA4 5NG

\*Disk drives supplied by Hitachi Europe Ltd.

### A complete package

We've taken the proven and reliable Hitachi 3" drive and housed it in rigid steel, textured and coloured to match your BBC micro. We've included format and verify utilities on both disk and EPROM. And we've added cables, manual and free disks.

### 3" – The new standard

Japan, home of the major disk drive manufacturers, has decided to make the new 3" disks a standard. And no wonder. Not only are they strong and easily stored, they give 100K per side, and you simply flip them over in the same way as a music cassette. The small light on the casing reminds you which side you are using.

The disk is totally encased in rigid plastic, with no exposed surfaces, is easily inserted with one hand and simply removed by pressing

*A+B Computing (Sept) stated – "excellent manual" ... "its simplicity of use must recommend the Hitachi 3" drive to anyone about to purchase a disk drive" ... "the microdisk is a marvellous change" Personal Computer News "protective sleeve and hard plastic exterior provide for greater protection" ... "far more durable and easy to handle than normal drives"*

TO: Advanced Memory Systems Ltd, Woodside Technology Centre, Green Lane, Appleton, Warrington, Cheshire WA4 5NG.

Please send me by door-to-door courier:

\_\_\_\_\_ (qty) AMS-3 (S) single disk drives at £225 each with free disk.

\_\_\_\_\_ (qty) AMS-3 twin disk drives at £399 each with free disk.

(Prices include EPROM, utility disk, cables, manual, VAT and delivery).

Please send me by post, if not with drives:

\_\_\_\_\_ (qty) double sided (100Kx2) disks at £4.95 each.

\_\_\_\_\_ (qty) packs of five at £22.50 per pack.

\_\_\_\_\_ (qty) utility EPROM at £15.

I enclose a cheque for £ \_\_\_\_\_

or debit my credit card

No \_\_\_\_\_

Name \_\_\_\_\_

Address \_\_\_\_\_

Post Code \_\_\_\_\_

Tel No \_\_\_\_\_

Signature \_\_\_\_\_

Please allow up to 28 days for delivery.

BBM 12



# ROMS

## SOFTWARE FOR THE BBC MICRO

### WORDWISE

32K

```

WORDWISE
(C) Computer Concepts 1982

1) Save entire text
2) Load new text
3) Save marked text
4) Load text to cursor
5) Search and Replace
6) Print text
7) Preview text
8) Spool text

ESC Edit Mode

Please enter choice_
    
```

The renowned word processing package. Still clearly the market leader with sales now over 20,000. This has become "the standard" word processor for the BBC Micro and is still receiving very favourable reviews. Wordwise will work with tape, disc or Econet and includes automatic word counting and full control over text entered into the system. Supplied with a detailed spiral bound manual and an excellent free typing tutor program. After 8 months on the market there is still no other product as simple to use and as powerful as Wordwise.

£39.00 + £1.00 p&p + VAT

### GREMLIN

32K

```

A=FF X=FF Y=FF
S =01FF 88 10 E3 BF 92 93 DC 89
PC=FFFF DC FF FF 09 D0 00 00 FF
??
CFF0 48 4A 4A 4A 4A AA BD 1F HJJJJ
CFFB C3 05 D2 45 D3 91 DB 98 E
M =D000 18 69 08 AB 68 29 0F AA i h)
D00B BD 1F C3 05 D2 45 D3 91 E
D010 DB 98 E9 08 AB 10 D7 60
D01B 9B E9 21 30 FA AB B1 DE io
-----
! START=D000
!D START START+9 S
D000 18 CLC
D001 69 08 i ADC #0
D003 AB TAY
D004 68 h PLA
D005 29 0F > AND #F
D007 AA TAK
D00B BD 1F C3 LDA C31F,X
-----
!LVAR
START D000
!M=START
    
```

The GREMLIN system is a powerful de-bugging tool for 6502 machine-code programs. It includes all the usual features found in good machine-code monitors, such as memory search, intelligent memory move routines, memory editors etc. These work at byte, word or string level. A built in help menu can also be displayed at any time.

This ROM contains many more unique features such as an assembler as well as a disassembler. An extremely powerful expression evaluator is included allowing complex expressions to be entered in a format that is only normally available in high level languages. Variables are also allowed (any length) and may be included into expressions.

GREMLIN allows single stepping through machine-code programs. It is also possible (on to a printer or disc) to single step through graphic routines without disturbing the screen.

Supplied with full manual, this 8k ROM has more features than any other de-bugging package for the BBC machine.

£28.00 + £1.00 p&p + VAT

```

DISC DOCTOR 1.07
DIS <(sta) <(end) <(cofs)
DISCTAPE <(asp) <(afsp)
DOWNLOAD <(asp) <(adr)
DSEARCH <(str) <(trk) <(trk)<(act)<(drv)
DZAP <(trk) <(trk)<(act)<(drv)
EDIT <(key no.)
FIND <(str)
FORM <(drv) <(no. trks) <(ctt) <(S)
JOIN <(asp) <(afsp) <(afsp)
MENU <(drv)
MOVE <(dest page) <(src page)
MSEARCH <(str) <(adr)
MZAP <(adr)
PARTLOAD <(asp) <(cofs) <(ext) <(adr)
RECOVER <(trk) <(act) <(act) <(adr) <(drv)
RESTORE <(trk) <(act) <(act) <(adr) <(drv)
SHIFT <(src) <(dest) <(ext)
SWAP <(drv)
TAPEDISC <(afsp)
VERIFY <(drv) <(no. trks) <(ctt)
OS 1 20
Press any key.
    
```

### DISC DOCTOR

32K

This utility package has many special features for use with discs but also contains many other utilities that everyone will find useful: Function key editing, powerful disassembler, recovery of any data from the disc, merging of files, complete disc editor. Compatible memory editor, String search in memory or on disc, automatic tape to disc and disc to tape routines, built in help menus, formatting of 35, 40 and 80 track discs, and also a special format that allows 60 files per disc.

£28.00 + £1.00 p&p + VAT

```

TERMI - BBC TERMINAL PROGRAM RELEASE 2.0
FROM COMPUTER CONCEPTS
(C) B.J.Martin and M.Ailes 1983
-----
Function key definitions
-----
Key --- Key use --- Shift with --- Key with ---
No. --- Shift --- CONTROL ---
#B Printer start stop
Change Mode #B char #B char
pooler start stop
transmit file start abort
transmit file cause continue
mulate custom BBC line
et handshake custom none
Special funct'n ESCI set Mask
Special Options Full/Half Parity
Reset Soft Hard
SHIFT/CONTROL FUNCTION KEYS
#B Print Screen.
Mode 7
Reset XMIT block.
    
```

### TERMI

32K

This program enables the BBC machine to act as an advanced terminal when connected to another computer or to a modem via the RS-423 (RS-232) interface. This provides facilities to transmit data from disc and the spooling of data from the 'line' to the disc or printer.

Termini has 3 modes of operation — dumb terminal, BBC graphics terminal and customised intelligent terminals including DEC VT52.

£28.00 + £1.00 p&p + VAT

**\* Forthcoming  
GRAPHICS ROM**

**COMPUTER  
CONCEPTS**

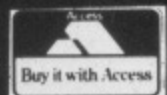

16 Wayside, Chipperfield, Hertfordshire. WD4 9JJ Telephone: Kings Langley (09277) 69727



# ARE YOU SERIOUS?

## STOP PRESS – REPLICA II NOW AVAILABLE

In addition to the features below it also works with Acornsoft "locked" programs plus very long programs (HEX & E00 to 7B00)

REPLICA II and THE KEY give you, the user, what you want. You have bought your disc drives and now want to take advantage of them, but most of your favourite software will not run with the disc interface and even if you are prepared to pay out for disc versions of everything you can't get them and if you have 80 track drives you might as well give up. If you know everything about the DFS, memory locations, saving procedures etc, you can probably save some of them onto disc. What's a half hour per program, and it only takes a few minutes to find, load and relocate it each time (if you can remember the sequence).

On the other hand you could buy REPLICA, enter a few details i.e. 1) program name, 2) number of sections, 3) CHAIN, \*RUN or \*LOAD 4) press play and then make a cup of tea whilst the program loads from cassette for the last time. When you return the program will be on the disc and shown in a menu under the name you gave it. There are now only two alternative storage methods required and one of them will work with most programs. There are some exceptions to REPLICA II but the number is insignificant. Many users have purchased 4 or 5 copies of REPLICA and it is now the recognised format that dealers use to display their software.

REPLICA II will now hold up to 16 programs on each disc, they can be erased if required and a new batch saved, but why not just buy another REPLICA and keep your programs on disc permanently (it only costs approx. £1.00 per program).

REPLICA II **£12.00** (state 40 or 80 track)

## THE KEY

THE KEY provides you with the facilities that should have been included in the Disc Filing System and also helps you reach the parts other discs can't reach. This new version of THE KEY has been made compatible with ECONET at the request of many schools, colleges and universities. The whole program has been turbocharged and the facilities are:

- 1) FORM40 – now much faster.
- 2) FORM80 – now much faster.
- 3) BACKUP – has that effect on some people because it allows even most of the protected discs to be backed up – faster too.
- 4) EDITOR – display, read and alter sectors, even if you can't list the program. Highlight any byte whilst searching, make additional searches, edit bytes – now allows entry in HEX or ASCII and in string format. Dump a sector to printer, file pointers etc etc. You can now see how data is stored on a disc and alter it if you wish. Of course, it's also faster.
- 5) RETRIEVE – don't despair when you have a corrupted disc or if a program is accidentally deleted, using RETRIEVE your worries are over.

With so much from one utility it is no wonder that THE KEY is outselling programs that cost the same but provide far less.

THE KEY **£12.95** (state 40 or 80 track)

## GRAFKEY/GRAFDISK

The first and best CAD program for the BBC Micro. Used in education, business, art, video etc. Recommended by LASERBUG, BBC MICRO USER, PCW, SOFT and thousands of satisfied users (see earlier issues of BBC Micro User for screen pictures). In a comparative review of the major CAD programs PCW said: "Considering the options it is by far the best value". Need we say more, if you need a graphics utility then this is it.

GRAFKEY (joystick & keyboard) **£9.00**  
GRAFDISK (state 40 or 80 track) **£12.95**

## SHADOW

A tape cloning program that will enable you to make security back ups of your valuable cassette based software.

SHADOW works with 99% of all known programs including those with "locked" sections or those containing 300 BAUD sections. Handles programs of any length and works with any operating systems.

SHADOW is the definitive tape backup system. Also on the same tape is a very useful program called "INSPECTOR" which allows the user to page through memory, search for a string, etc.

BOTH PROGRAMS **£8** incl.  
(This program for personal use only).

## JOYSTICK UTILITY

Converts non-joystick programs to work with joysticks. Works with any program using INKEY(-), which applies to most programs. Easy to use, just press the keys you want to transfer. Supplied on cassette but can be transferred to disc.

CASSETTE **£6.00**

## SINGLE KEY ENTRY Requires 1.2 O.S.

A very useful utility that provides single key input of 66 key words. Just like having 66 function keys. Compatible with issue 1 & 2 basic and discs.

CASSETTE **£5** inclusive

## JOYSTICKS

Pair of fully proportional joysticks of compact and handy size

**£17.95**

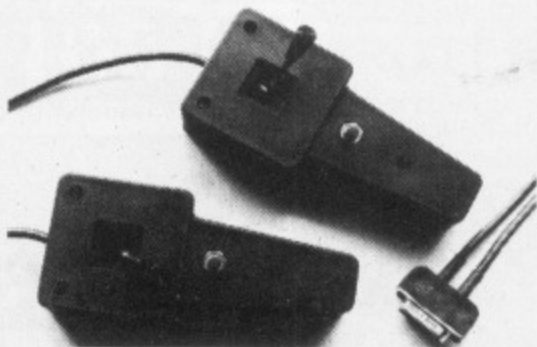

## EDUCATIONAL CORNER

(for the 5-11 age group)

**THE GARDEN** – 3 programs with superb graphics. Covers: colours, spelling and understanding. Cassette **£8.00**

**COUNTING** – robots, rockets, flowers, etc. Excellent graphics, good range. Cassette **£6.00**

**MATCHING** – 4 programs covering numbers, words, shapes and patterns. Cassette **£7.00**

**HUE-MEN** – A superb teaching-aid, using animation techniques in Mode 7. A hit with adults and children alike. Cassette **£6.00**

And now **SHAPE MEN** using the same techniques. This is the second in an integrated approach to teaching. **£6.00**

**INTRO** – A simple programming language which uses the immediate visual response of "Turtle" graphics to introduce a number of programming concepts and techniques. Cassette (and 9 page manual) **£10.00**

## PROGRAMMERS

We are constantly seeking new and interesting programs. Why not send yours for appraisal? You have got nothing to lose but much to gain – So why not send your program today? 40 track disc if possible or two copies on cassette. In some cases we will even provide disc drives against future royalties.

## CLARES MICRO SUPPLIES



Dept. BMU12, Providence House,  
222 Townfield Road, Winsford,  
Cheshire CW7 4AX.  
Tel: 06065 51374

All prices inclusive of  
VAT + Carriage – No Extras.







Vol. 1 No. 10 December 1983

*Managing Editor*  
**Derek Meakin**

*Features Editor*  
**Mike Bibby**

*Technical Editor*  
**Mike Cook**

*Art Editor*  
**Peter Glover**

*Advertisement Manager*  
**John Riding**

*Advertising Sales*  
**Mike Hayes**

*Marketing Manager*  
**Sue Casewell**

*Editor-in-Chief of  
Database Publications:*  
**Peter F. Brameld**

Tel: 061-456 8383 (Editorial)  
061-456 8500 (Advertising)

Telex: 667664 SHARET G  
Prestel: 614568383

**Published by:**  
Database Publications Ltd,  
Europa House, 68 Chester Road,  
Hazel Grove, Stockport SK7 5NY.

**Subscription rates for  
12 issues, post free:**

£12 - UK  
£13 - Eire (IR £16)  
£18 - Rest of world  
(surface)  
£30 - Rest of world  
(airmail)

The Micro User welcomes program listings and articles for publication. Material should be typed or computer-printed, and preferably double-spaced. Program listings should be accompanied by cassette tape or disc. Please enclose a stamped, self-addressed envelope, otherwise the return of material cannot be guaranteed. Contributions accepted for publication will be on an all-rights basis.

© 1983 Database Publications Ltd. No material may be reproduced in whole or in part without written permission. While every care is taken, the publishers cannot be held legally responsible for any errors in articles or listings.

*The Micro User is an independent publication and neither the BBC nor Acorn Computers Ltd are responsible for any of the articles in this issue or for any of the opinions expressed.*

Distribution to the news trade in the UK and Ireland is by Wells Gardner, Darton and Co Ltd., Faygate, Horsham, West Sussex RH12 4SU (tel: Faygate 444). Enquiries regarding overseas distribution should be made direct to the publishers.

## CONTENTS

### NEWS

23

Keep your finger on the pulse of BBC Micro happenings with our latest news bulletin.

### SLOW DOWN

31

How to slow your programs. An invaluable utility for the disabled, children - or cheats!

### BEGINNERS

32

Cursor codes, loops and triangles of asterisks in our series to help new users.

### CHESS

39

A leading chess expert shows you how to test and evaluate three competing programs.

### GRAPHICS

45

We treat user defined characters in a colourful and seasonal way in the latest of the series.

### SOFTWARE SCENE

49

Our team of frank and thorough reviewers assess some of the latest software releases.

### TOWER BRIDGE

54

Evade ghosts and collect treasures from Tower Bridge with our latest all-action game.

### TAPE OFFER

57

Save yourself the chore of keying in programs from this issue with this month's cassette.

### PAGED GRAPHICS

58

How to create fast action graphics using the registers of your BBC Micro's video chip.

### COMPETITION

63

A chance for three lucky readers to win themselves a year's access to Micronet.



**FREE!**

Inside this  
issue

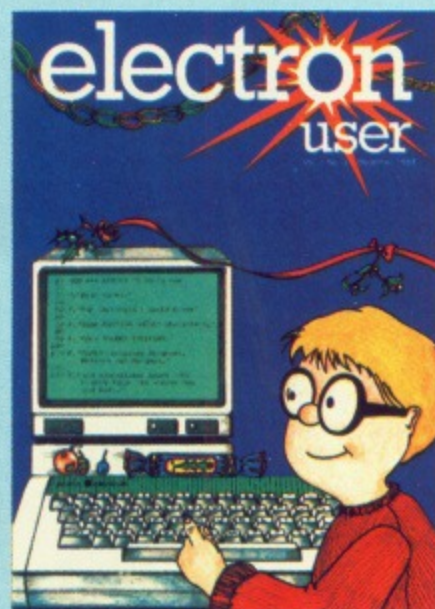

*Electron User – the third, program-packed edition of the new magazine that's essential reading for all Electron users.*

**67 CHARACTER CODER**

An invaluable utility that enables you to design and manipulate user defined characters.

**73 SANTA'S SAUCER**

Industrial action has hit the North Pole. Can you help Santa deliver his presents?

**81 CHRISTMAS CARD**

We use the BBC Micro to send appropriate Season's Greetings to all our readers.

**83 SOUND ADVICE**

How to turn the noises your micro makes into something approaching the sound of music.

**91 HARDWARE REVIEW**

Our impartial experts give their assessment of new pieces of hardware for the BBC Micro.

**92 BODY BUILDING**

Make your micro the star of your Christmas party with the latest in our upgrade series.

**98 SUBSCRIBE NOW**

A year's subscription to the Micro User will bring you a FREE copy holder and crib sheet.

**103 COMPUTERSPEAK**

Our jargon decoder gives the real meaning of the buzz-words you thought you understood.

**131 MICROMAIL**

The section that you write yourself – just a few of the letters that pour in every month.

**141 BACK ISSUES**

Make sure your Micro User collection is complete. All you've missed and how to get it.



# ONE-STOP SHOPPING

KEENEST PRICES,  
PROMPT, RELIABLE  
SERVICE ---  
That's **TWILLSTAR!**

## BBC MICROCOMPUTER

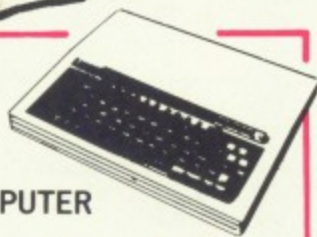

Model B	£399
Model B & Disc Interface	£469
Model B & Econet	£446
Model B & Econet & Disc Int	£516
Disc Interface Kit	£97
* Speech Synthesizer (official BBC)	£54
Teletext Receiver	£225
1.2 Operating System (incl. fitting)	£11.50
Basic 11	£15

\* New in stock. Price incl. fitting



NOW AVAILABLE  
THE ACORN ELECTRON  
ONLY **£199.00**

## WORD PROCESSORS

View Word Processor	£59
Word Wise Word Processor	£45

## Logitec-FT 5001

STAR BUY

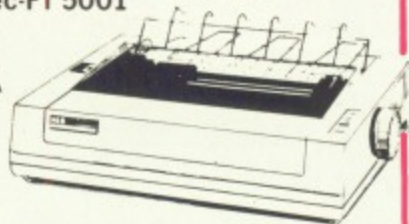

Friction and adjustable sprocket feeding, variety of printing models. (PICA & ELITE pitch) user font registry command, automatic paper insertion, 96 ASCC11 with descender, 8 international character sets, 48 semi graphics!

At the very low price of **£330**

Just look at our prices and selections: but if you don't see what you want please telephone us, as we are unable to list all the items we stock. We will be more than pleased to give you our Best price, and our very best wishes for Christmas!

## DOT MATRIX PRINTERS

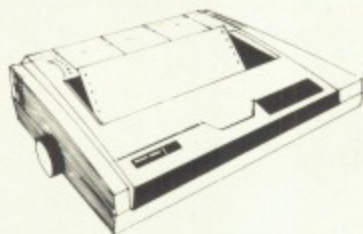

### MANNESMANN MT80

High quality 80 column serial dot matrix printer. Dual density dot addressable graphics, quick tear facility as standard, optional sound reduction kit to give an impressive L55dBa acoustic noise rating. Ability to handle both tractor-fed fanfold and single paper.

Special price of **£295**

FREE CABLE AND PAPER WITH ALL PRINTERS.

## EPSON F80

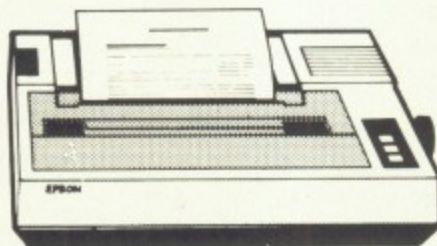

Epson FX80 F/T	£425
Epson RX80 F/T	£315
Epson FX100 T/T	£499

## SHINWA CP80

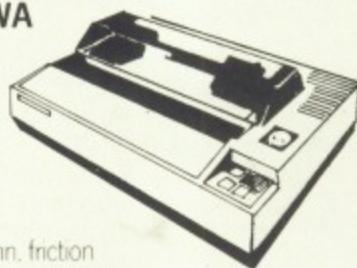

80 column, friction and adjustable tractor feed, bidirectional logic seeking, HI-RES graphics and block graphics, sub and superscripts, condensed and emphasised print, and underlining, vertical and horizontal tabs, self test, italic print, etc.

Shinwa CP80 F/T	£289
Parallel Printer Lead	£13
2000 Sheets Fanfold Paper	£15

## ODDS

Official Joysticks	£13
Compatible Joysticks Damping Control	£15
Dust Covers - for various machines - from	£3.95

## DAISYWHEELS

NEWS FLASH!  
ACORNS APPOINTED  
SIECONET  
APPROVED  
SERVICE CENTRE

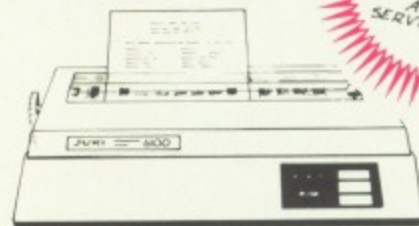

### JUKI 6100

20 CPS print speed, supports all wordstar features, emulates diablo protocols.

Juki 6100 Daisywheel with 2K Buffer **£395**

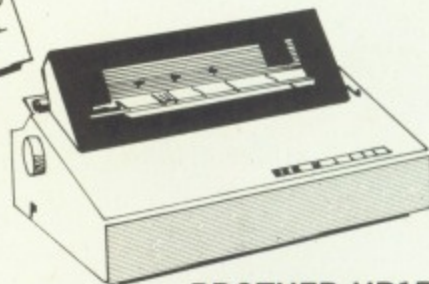

### BROTHER HR15

Buffer ... 3K byte, shadow printing, super/sub script, carriage skip movement, text reprinting, colour printing (red and black), auto under-scoring, proportional spacing, clear buffer—

Also available with keyboard.

Brother HR15	£431
Keyboard	£176

Silver Reed Printer/Typewriter inc. RS232 Interface EX43 & 2K Buffer **£395**  
(Just plugs into your BBC)

**STAR BARGAIN!**

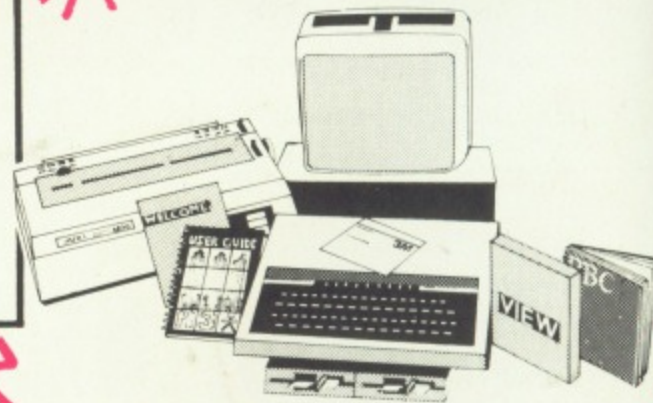

BBC Model B plus Disc/Interface fitted view, V.D.U. Green Monitor, Juki Daisywheel Printer, 200K Dual Disc Drives and manual and formatting disc. **ONLY £1,360** (incl. all cables)

ALL PRICES INCLUSIVE OF VAT.



# Twillstar Computers Limited

Microcomputers, Peripherals, Software, Service Contracts.

INVITATION TO **MICRO USER SHOW**  
Westminster Exhibition Centre  
Greycoat Street, London, SW1  
**Dec 8, 9, 10, 11, 1983**  
STAND Nos. 97, 98, 107, 108  
Ask for your complimentary ticket now! Come and see us to pick a special gift for Christmas!  
\* BARGAINS \* SPECIAL PRODUCTS



# to fill your Christmas **MICRO** stocking!

## MONITORS

### SANYO SM12H



Sanyo 14" Phosphor Green Display, steady 80 character x 24 line display, etc.

SM12H  
Priced at.....£79

SM12N Sanyo 14" Priced at.....£113



Phoenix Data Display Monitor - 12" diagonal face, high resolution green and amber.

Priced at.....£89

### PHILLIPS 2006



14" colour TV/Monitor.....£255  
Expertly converted, come to our showrooms and compare. Use it for good resolution colour monitor, or watch your favourite TV programme.

### OTHER

Microvitec 14" 1431.....£247  
BBC Official 12".....£95

## TORCH DISK PACK

Torch Z80 Disk Pack  
4MH3 Z80 Application Processor  
Perfect Software

At New Low Price

£835.00 Inc. Installation

## SLIM DISK DRIVES

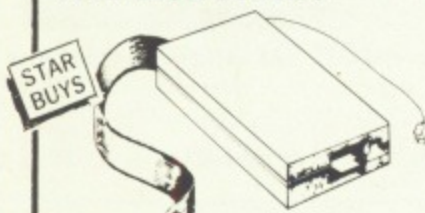

### TEAC 55A

S/S 40 TRACK  
100K SD Single £169  
200K DD Dual £339

### TEAC 55E

S/S 80 TRACK  
200K Single £220  
400K Dual £440

### TEAC 55F

D/S 80 TRACK  
400K S/D Single £269  
800K D/D Dual £539

### MITSUBISHI

400K D/S DD Single £269  
Dual £539

FORMATTING DISK & MANUAL £10

\*ALL DRIVES CASED WITH FREE CABLES

- \* SERVICE CONTRACTS TO EDUCATION AUTHORITIES AT DISCOUNT
- \* OFFICIAL ORDERS FROM DEALERS, GOVERNMENT DEPARTMENTS, COLLEGES AND SCHOOLS WELCOME
- \* ALL PRICES INCLUSIVE OF VAT

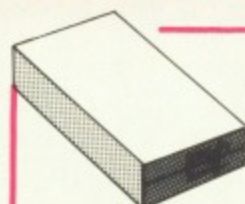

## KOMORI - MICROPROCESSOR CONTROLLED

Ideal for BBC Micro, and any other computers with standard interface. 5 1/4" Slimline, on-board single chip microcomputer reduces TTL count by 70%, extra low power requirement, direct drive (no belts), guide rail means completely quiet operation, unique eject mechanism, fast 6ms track to track access time, fully guaranteed. Cased with leads.  
Priced at the **STAR BARGAIN PRICE** of **£169**

Power supply £40  
Cables Single £9.50  
Cables £13.50

## FLOPPY DISKS



Floppy Disks in packs of 10  
Single sided 40 Track £20  
Double sided 80 Track £35

## BBC Compatible

### KLICK STIK JOYSTICK - SELF CENTRING

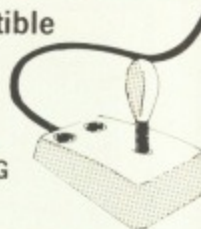

Two Fire Buttons

Single - £17.95

Dual - £34



## SANYO

### SLIM 3G

The slim 3G Sanyo Cassette Recorder only recently available in the market. ONLY £28.95  
Official BBC Cassette Recorder £29.95  
Cassette Recorder lead £2.50



## UTILITY SOFTWARE



Screen Dump Rom

£17.25

Analyse Disk

£15

Compatible for MX80, FX80 etc.

## NEW BOOKS AND SOFTWARE IN STOCK

\*\*\*\*\*

## FITTING SERVICES AVAILABLE

## SOFTWARE ACORN SOFT GAMES

Creative Graphics £9.95  
Graphs & Charts £9.95  
Desk Diary £9.95  
Monsters £9.95  
Snappers £9.95  
Planetoid £9.95  
Arcade Action £11.50  
Rocket Raid £9.95  
Meteors £9.95  
Arcadians £9.95  
Sliding Block £9.95  
Cube Master £9.95  
Chess pack £9.95  
Super Invaders £9.95  
Missile Base £9.95  
Snooker £9.95  
Starship Command £9.95  
Draughts/Revers £9.95

## ADVENTURES

Sphinx Adventure £9.95  
Philosophers Quest £9.95  
Castle of Riddles £9.95  
Countdown to Doom £9.95

## LANGUAGES

Lisp £16.85  
Forth £16.85  
Microtext £49.85  
BCPL £99.00

## EDUCATION

Algebraic Manipulation £9.95  
Peeko Pack £9.95  
Business Games £9.95  
Tree of Knowledge £9.95  
Sentence Sequencing £11.90  
Word Sequencing £11.90  
Missing Signs £11.90  
Number Balance £11.90  
Word Hunt £11.90  
Speed & Light £11.90  
Density & Circuit £11.90  
Chemical Analysis £13.80  
Chemical Simulations £13.80  
Chemical Structures £13.80  
Jars £11.90

## BOOKS

Creative Graphics £7.50  
Graphs & Charts £7.50  
Lisp £7.50  
Forth £7.50  
View Guide £2.50  
Intro View £2.50  
BCI Manual £15.00

## BBC GAMES SOFTWARE (BUG BYTE)

Galaxy Wars £7.50  
Oblivion £7.50  
Red Lord £7.50  
Music Synthesizer £9.50  
Graphics Package £9.50  
Old Farmer Tyme £9.50  
City Defence £9.50

## (COMPUTER CONCEPT)

Asteroid Belt £8.99  
Characters £6.65  
Hitch-Hiker £6.65  
Snake £8.95  
Space Hawks £8.95

## HOW TO ORDER

You may purchase any of the items listed by cheque, Barclaycard or Access. All you have to do is fill in the details in the coupon below and list your requirements on a separate sheet of paper. Post to us and we will despatch within 7 to 14 days. All prices inclusive of 15% VAT.

Add £2.50 P&P for orders below £150, over, add £8 P&P.

## TELEPHONE ORDERS (01) 574 5271

Credit card holders may order by telephone. Give Card No., Name, Address and item required.

Post to:

TWILLSTAR COMPUTERS LTD,  
17 REGINA ROAD, SOUTHALL, MIDDLESEX.

I have enclosed my list of requirements along with my cheque/P.O. for £ \_\_\_\_\_

I prefer to pay with my ACCESS/BARCLAYCARD (Delete whichever not applicable)

CARD NO. \_\_\_\_\_

SIGNATURE \_\_\_\_\_

NAME \_\_\_\_\_

ADDRESS \_\_\_\_\_

TEL: (Day) \_\_\_\_\_

TEL: (Eve) \_\_\_\_\_

CREDIT CARDS VALID IF SIGNED BY CARD HOLDER. ADDRESS ABOVE MUST BE THE SAME AS CARD HOLDER.



17 REGINA ROAD · SOUTHALL  
MIDDLESEX · TEL: (01) 574 5271  
(OPEN SIX DAYS A WEEK - 10 a.m. to 8 p.m.)



# FLOPPY DISC SYSTEMS FOR THE BBC MICRO

**mws** announce a complete range of Disc Drives that are compatible with the BBC Micro and other micro-computers that utilise the Shugart SA400 Interface.

- **DISC DRIVE UNITS** come complete with high quality steel box, 40/80 Track Formatting Disc, Interface Cable and manual.
- All you need to do is plug into your BBC and you are ready to have access to large amounts of storage space.
- All single units can be upgraded to double units.
- All units carry a 1-year warranty.
- Optional power supply available. **£35**

**EXCITING NEW PRODUCT RELEASE** – See it at the London BBC Micro User Show



800K for only **£399**

**MWS Dual 400K Drives (Total 800K)**



400K for only **£233**

**MWS Single 400K Drive**

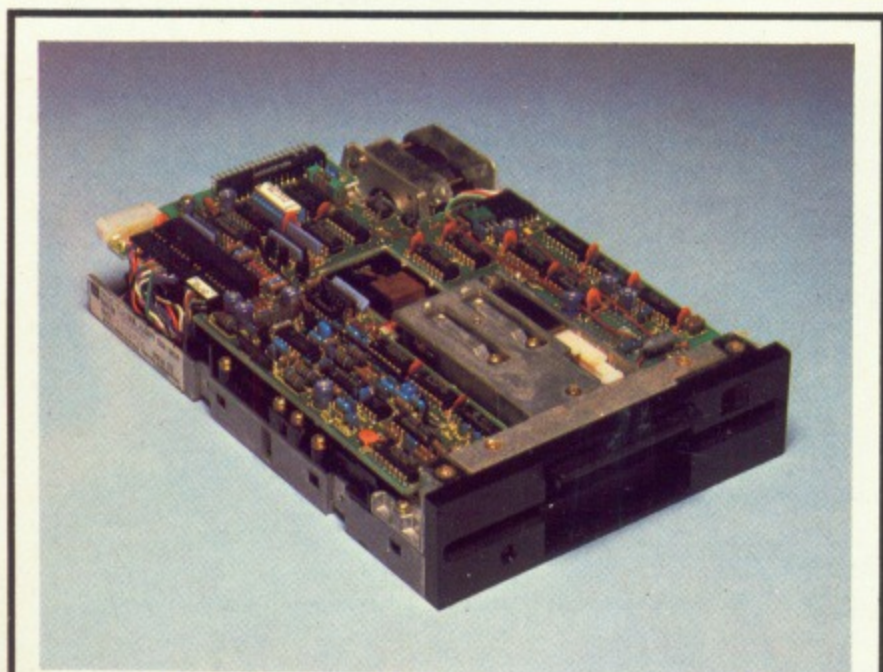

**MWS Single 400K Upgrade £220**

## **mw systems ltd.**

Matrix House  
Lincoln Road  
Cressex Industrial Est.  
High Wycombe  
Bucks  
Tel (0494) 450341

### ORDER FORM

Please send me the following items	Quantity	£
Dual 400K Drive Unit (800K) at £399		
Single 400K Drive Unit. . . . . at £233		
Single 400K Upgrade. . . . . at £220		
Power Supply. . . . . at £35		

Please debit my  Sub total   
 VAT at 15%   
 TOTAL

I enclose a cheque for £..... made payable to MW Systems Ltd

Name \_\_\_\_\_ Company \_\_\_\_\_

Address \_\_\_\_\_

Tel No \_\_\_\_\_

All prices are exclusive of VAT  
Available from Stock – Disc Interfaces P.O.A.



# Computerama

## GRUNDIG 14" TV/MONITOR

RGB input for a super clear display. The picture must be seen to be believed. We have not seen better colour on any dedicated monitor.



ORDER TODAY, we guarantee that you will not be disappointed. And remember, when you finish computing, just flick the switch and you have a super quality 14" colour TV - what better way to justify the expense to your wife or girlfriend!

Complete with lead for BBC for only

**£289 inc VAT**

## NEC PC8023 PRINTER

This superb Japanese dot matrix printer, justly famous for its reliability and print quality is now available for BBC users.

- \* Full graphics and proportional spacing
- \* True descenders
- \* Centronics interface
- \* 7 x 9 matrix
- \* Friction and tractor feed
- \* 2K buffer
- \* 100 c.p.s.
- \* bi-directional, logic seeking 80 column \* superscript
- \* subscript \* underlining \* hi-res block graphics \* dot addressable mode.



A truly exceptional printer for only

**£348 inc VAT.**

Replacement ribbons £7.90 inc VAT.

## AT PL SIDEWISE Rom Expansion Board

- \* Full sidewise Rom Expansion to 16 Roms
- \* 16K Battery backed CMOS Ram option
- \* No soldering required to fit sidewise
- \* Plug-in-and-go construction - Mounts neatly inside the BBC machine.
- \* Full buffering of address and data busses - prevents data bus loading problems associated with unbuffered boards.
- \* Pin1 of on board sockets are connected properly - No spurious crashes due to this known fault on BBC
- \* Existing sockets on BBC are usable. All eprom sockets are accessible without removing sidewise.

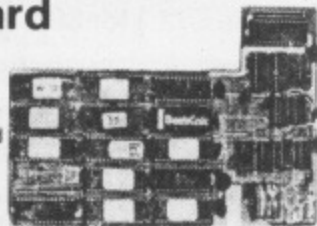

**ONLY £43.70**  
+ £1.00 carriage

## TORCH Z80 DISC PACK with over £1,100 of software FREE



**NOW ONLY £835 inc. vat**

Free carriage UK only

Software includes:  
\* PERFECT WRITER \* PERFECT SPELLER \* PERFECT CALC \* PERFECT FILER \* TORCH NET \* Comanex - The Interactive Management Game. Approved and used by leading management consultants. The TORCH Z80 DISC PACK is the most powerful BBC Disc upgrade available, it provides 800K of storage plus a Z80 Second Processor running Torch's own CP/M compatible operating system - over 200 packages now available - discs can also be used for storage under Acorn D.F.S. system.

Clip this ad to your order to receive free 40/80 T converter program.

BBC	INC VAT
Acorn Electron	199.00
BBC Model B	399.00
BBC Model B + DOS	469.00
BBC Disc Upgrade	97.00
BBC A-B Full Upgrade	69.00
BBC Teletext Receiver	225.00
BBC Z80 2nd Processor	289.00
BBC 6502 2nd Processor	299.00
<b>DISC DRIVES</b>	<b>INC VAT</b>
LVL Single x 100K Drive	265.00
LVL Expansion Drive	149.00
LVL Dual 100K	389.00
Pace Single 100K	212.00
Pace Single 40/80T D/Sided	368.00
Pace Dual 100K	388.00
Pace Dual 40/80T D/Sided	699.00
Torch Dual 400K Z80 Disc Pack	835.00

### ORDER A COMPLETE SYSTEM - GET ALL LEADS FREE

MONITORS	INC VAT
Microvitec 14" Colour	247.00
Sanyo 14" Colour	286.00
Kaga 14" Colour M/Res	274.85
Kaga 14" H/Res	327.75
Kaga 14" VH/Res	458.85
Sanyo 12" Green	99.00
Kaga 12" Green	125.00
14" TV/Colour Monitor	289.00
Kaga 12" Amber	136.85
RGB-BBC - Kaga	8.00
<b>PRINTERS</b>	<b>INC VAT</b>
Epson RX80	308.00
Epson RX80FT *NEW	366.85
Epson FX80	425.00
Epson FX100 *NEW	569.00
NEC PC8023	348.00
Star OP510	289.00
Shimwa CP80	295.00
Juki 6100 Daisywheel	429.00
Smith Corona TP1/E	389.00

### RING FOR LATEST PRICES, MANY REDUCTIONS EXPECTED

MISCELLANEOUS	INC VAT
Sanyo DR101 Data Recorder	44.95
Cassette leads - all types	2.80
Acorn Joysticks	13.00
Quickshot Joystick (BBC)	19.95
Printer Cable (Parallel) 1.2 m	13.00
BBC Deluxe Cover	5.95
Light Pen	28.75
Data Cassettes 5 x C20	1.95
The Plug Power Filter	14.95
<b>ROM SOFTWARE</b>	
Wordwise	39.95
View	59.00
Beebcalc	39.00
Disc Doctor	32.95
Termi (terminal emulator)	32.95
Pace D.F.S.	39.95
LVL Double Density Upgrade	89.95
ROM Expansion Board (ATPL)	43.75
System Spy	23.95
<b>BOOKS</b>	<b>NO VAT</b>
Advanced User Guide (carriage £2)	12.95
30 Hour Basic	5.95
A.L.P. for BBC Micro	8.95
BBC Revealed	7.95
Let your BBC Micro teach you to program	6.45
Basic Programming on the BBC Micro	5.95
Creative Graphics	7.50
Graphs & Charts	7.50
Lisp Manual	7.50
Forth Manual	7.50
BCPL Manual	15.00
35 Educational Programs	6.95
30 Programs for BBC	4.95
Further Programs	5.95
100 Programs for the BBC Micro	6.95
Discovering BBC Machine Code	6.95
Easy Programming for the BBC Micro	5.95
21 Games for the BBC	5.95
BBC Disk Manual	1.95
The Book of Listings	3.75
The BBC Micro an Expert Guide	6.95
Introducing the BBC Micro	5.95
The Computer Book	6.75
Programming the BBC Micro	6.50
Further Programming the BBC Micro	5.95
Using Floppy Disks with the BBC Micro	9.95
Creating Adventure Programs on the BBC	6.95
Games BBC Computers Play	6.95

WE ACCEPT INSTITUTIONAL EDUCATIONAL ORDERS

### PROGRAM POWER

Killer Gorilla	7.95
Chess B	7.95
Hell Driver	7.95
Asteroid Storm	7.95
Barrage	7.95
Cowboy Shoot Out	6.95
Croaker	7.95
Danger UXB	7.95
Eldorado Gold	6.95
Escape Moonbase Alpha	7.95
Felix in Factory	7.95
Felix & Fruit Monsters	7.95
Galactic Commander	7.95
Junior Maths	6.85
Laser Command	7.95
Seek	6.85
Swoop	7.95
Time Trek	7.95
World Geography	6.85
Where	6.85
Caveman Adventure	6.85
Filer	10.30
Chemistry	6.85
Physics	6.85
Adventure	7.95
Demon Decorator	6.85
Footer	7.95
Alien Swirl	7.95
Alien Destroyers	7.95
Moon Raider	7.95
Labyrinths of LaCosh	7.95
Wall	5.70
Beebtote	5.95

### SUPERIOR SOFTWARE

O-Bert	7.95
Colditz Adventure	7.95
Alien Dropout	7.95
Centigede	7.95
Fruit Machine	7.95
Galaxians	7.95
Space Fighter	7.95
Road Runner	7.95
Hunchback	7.95

### COMPUTER CONCEPTS

Logo 2	11.50
Chess	8.95
Games Galore	8.95
Space Hawks	7.95
Draughts	8.95
Swarm	8.95
Snake	7.95
Android Attack	8.95
Asteroid Belt	7.95
<b>OPUS</b>	<b>INC VAT</b>
Dogfight	9.95
<b>KOSMOS</b>	<b>INC VAT</b>
French Mistress Level A	9.95
French Mistress Level B	9.95
German Master Level A	9.95
German Master Level B	9.95

### BUG-BYTE

Old Father Time	9.50
City Defence	7.50
Space Pirates	5.50
Music Synthesiser	9.50
Space Invaders	5.50
Galaxy Wars	7.50
Space Warp	9.00
Sea Lord	7.50

### BBC/ACORNSOFT

Algebraic Manipulation	9.95
Arcade Action	11.95
Arcadians	9.95
Business Games	9.95
Castle of Riddles	9.95
Creative Graphics	9.95
Countdown to Noon	9.95
Cube Master	9.95
Desk Diary	9.95
Forth	16.85
Graphs & Charts	9.95
Hopper	9.95
Lisp	16.85
BCPL (Rom + Disc)	99.95
Missile Base	9.95
Meteors	9.95
Monsters	9.95
Peeko Computer	9.95
Philosophers Quest	9.95
Planetoid	9.95
Rocket Raid	9.95
Sliding Block Puzzles	9.95
Snooker	9.95
Sphinx Adventure	9.95
Starship Command	9.95

Super Invaders	9.95
Tree of Knowledge	9.95
Snapper	9.95
View	59.00
Speech Kit	55.00

### BASIC II NOW AVAILABLE £15.00 ONLY. FULLY DOCUMENTED

CLARE	INC VAT
Graphkey	7.95
Replica (Disc Only)	9.95
Graph Disc	12.95
Beeb-Synth	7.95
The Key (Disc Only)	12.95
Single Key Entry	4.95
Shadow/Inspector	7.95
State 40/80T for Discs	

QUICKSILVA	INC VAT
Music Processor	14.95
Beeb Art	14.95

<b>DR SOFT</b>	
747 Flight Simulator	6.95

<b>AMCOM</b>	
Space Highway	6.95

<b>GEMINI GAMES</b>	
Missile Control	9.95
Liberator	9.95
Caterpillar	9.95
Sleigh Bells	9.95
Traditional games	14.95

<b>GEMINI</b>	<b>INC VAT</b>
Cash Book Acc	95.00
Inv & Statements	19.95
Commercial Acc	19.95
Mailing List	19.95
Data Base	19.95
Stock Control	19.95
Home Accounts	19.95

<b>EASY TABS (Torch)</b>	<b>EXC VAT</b>
Sales Ledger	99.00
Purchase Ledger	99.00
Cash Book	99.00
Mail List	99.00
Word Processor	99.00

### SAME DAY DESPATCH ON STOCK ITEMS

MAIL ORDER  
Post your order today to  
**COMPUTERAMA**, 1 Sash Street, Stafford  
ST16 2PS Or telephone your Access or  
Barclaycard number, we will despatch  
immediately (0785) 41899.

Call in today. Home Computer Centre for the BBC enthusiasts.  
Send large SAE for further details of any product.



**CARRIAGE**  
Micro's Monitors, Disc Drives,  
Printers £8.00, Books £1 each.  
Cassette Decks £2.00, Leads and software  
50p/item, £1.50 max.

**WE EXPORT WORLDWIDE**  
Telex 36540 Hourds G.

## QUICKSHOT

### BBC

### JOYSTICK

Self centring joystick. Works even with keyboard only programs.  
A sensation at the Micro User Show.  
More fun - reaches the games other joysticks cannot.  
Limited supplies of this item.

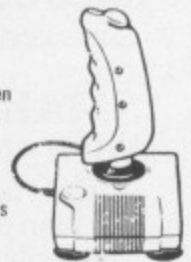

**£19.95 + £1.00 p&p**

# Computerama

## STAFFORD

59 Foregate Street, Stafford,  
ST16 2PR. Tel: (0785) 41899

## STOKE-ON-TRENT

11 Market Square Arcade,  
Hanley, Stoke-on-Trent,  
ST1 1PD.  
Tel: (0782) 268620

## SHREWSBURY

13 Castle Gates, Shrewsbury  
SY1 2AB. Tel: (0743) 60528



# Technomatic Official BBC Dealer

01-452 1500 01-450 9764 01-450 6597 Telex: 922800

## BBC

Model B £399, B+DFS £470, B+ECON £477  
B+DFS+ECON £518

Above prices incl. VAT Carr. £7.00  
Model A to B Upgrade Kit £60 Installation £15  
Floppy Disc Interface Kit £84

## WORD PROCESSORS

VIEW 16K ROM £52  
VIEW PRINTER DRIVER £8.65  
WORDWISE 8K ROM £34.50

## LANGUAGE ROMs

PASCAL-T £48  
BCPL £86  
BEEBCALC Spread Sheet ROM 8K £34  
DISC DOCTOR ROM £30

## BBC COMPATIBLE 5 1/4" DISC DRIVES

These drives are supplied in BBC matching colour cases and with necessary cables.

SINGLE DRIVES CASED	100K £150	200K £215*	400K £235
SINGLE DRIVES with PSU	100K £185	200K £260*	400K £300
DUAL DRIVES with PSU	2 x 100K £355	2 x 200K £475*	2 x 400K £510

\*These drives are provided with a switch between 40 and 80 tracks.

Carriage: £6 per Single drive; £8 per Dual drive.

Disk operating system manual for formatting diskette £12.50

## TORCH Z-80 PACK

Your BBC computer can be converted into a business machine at a cost slightly higher than a 800K disc drive. The Torch pack with twin disc drive and a Z80A processor card greatly enhances the data storing and processing capability of the computer (NOTE: In BBC mode the disc pack functions as a normal BBC drive). Z80A card comes with 64K of RAM and a CP/M compatible operating system. The system is supplied complete with a BBC owner's user guide, a Systems/Demo disc, a PERFECT software package and COMANEX, a business management game. The PERFECT software package comprises of a DATABASE, CALC, WORD PROCESSOR and SPELLER commercially valued at over £1000.

The complete package for only £730  
Carr. £8.

## TABS BUSINESS SOFTWARE FOR TORCH

Sales Ledger, Purchase Ledger, Mailing List £99 ea.

## SMARTMOUTH WITH AN INFINITE VOCABULARY

A ready built speech synthesiser unit, allowing the creation of any English word, with both ease and simplicity and at the same time being very economical in memory usage. No specialist installation—and no ROMs, simply plug into the user port. Smartmouth is supplied with demo and development programs on cassette, and full software instructions £37+£2 p&p.



## PRINTERS

NEC PC8023 BE-N (120 cps) £320  
EPSON RX 80 FT £305, FX 80 £370  
MX 100 £425, New FX 100 £565 now in stock, SEIKOSHA GP 100A £175, GP 250X £235 GP 700A £425

Juki 6100 Daisy Wheel Printer £385  
Printer leads: Parallel £12 Serial £8  
Serial Interface: EPROM + 2K Buffer £60  
NEC £60

Listing Paper 2,000 fanfold sheets 9 1/2" x 11" £13.50 + £3.50 p&p

Spare Ribbons available.

### Printer Sharer

Single Printer for up to 3 BBCs  
£59.95 + £2 p&p

## DISKETTES (In packs of ten)

SSSD (40) £15 SSDD (80) £24  
SSDD (40) £18 DSDD (80) £26

(p&p £2 per pack)

Library Case £3 Lockable Storage Cases  
30/40 £17 60/70 £30 + £2 p&p.

## DISC CLEANING KITS

FLOPPICLENE Kit with 20 disposable discs  
£14.50+£1.50 p&p

SAFE KIT: Complete computer system clean  
kit £30 + £3 p&p

## CASSETTE RECORDER

Sanyo DR101 Data Recorder £39

BBC Recorder £28

Hi quality cassette lead £3

Audio Digital Cassette C12 1 for 50p 10 for £4.50

## SOFTWARE

Full range of **Acornsoft**, Program Power & GEMINI software in stock.

## GRAPHICS PLOTTER

This robustly built graphics plotter provides both versatility and precision. It has two motors, controlled by software which drives a small carriage above the plotter bed. The carriage can be moved with an accuracy of 0.025cm. over an area the size of A4 paper. The plotter bed can accept paper and far thicker materials, at sizes of up to A3. The basic plotter carries three pens which the computer can be programmed to use in any combination during a drawing/plotting operation. The pen mounts can easily be changed to accept a sharp-pointed scribe which can be used for etching fine line diagrams on a suitable surface. Extra accessories available include an opto-sensor which turns the plotter into a scanner which can scan a picture and display it on the screen. When a miniature drill is fitted on the carriage, the plotter can be used for drilling holes like the ones on pcbs. This versatile plotter can provide an endless source of creative ideas. Basic printer £290+£8 carriage. SEND FOR DETAILS ON THE VARIOUS ACCESSORIES.

## TECHNOMATIC LTD

MAIL ORDERS TO: 17 BURNLEY ROAD, LONDON NW10 1ED  
SHOPS AT: 17 BURNLEY ROAD, LONDON NW10  
(Tel: 01-452 1500, 01-450 6597, 01-450 9764, Telex: 922800)  
305 EDGWARE ROAD, LONDON W2 01-723 0233

We specialise in EXPORT orders. No VAT on export. Carriage at cost.

Orders from Schools, Colleges, Educational Departments and Government Establishments are always welcome. For fast delivery quote your Access or Visa number.

ALL PRICES EXCLUDE V.A.T.



# SPECIAL PRICING FOR BULK BUYERS

on Cables, Connectors, Floppy Discs, Eproms

## MONITORS

Colour: Microvitec RGB

Type 1431 14" Std. Res. £215 (Leads inc.)  
 Type 1451 14" Med. Res. £345 (Leads inc.)  
 Type 1441 14" High Res. £440 (Leads inc.)  
 Sanyo colour RGB 14" Std. Res. £200  
 Kaga colour RGB 12" High Res. £399  
 12" Hi Res. Green Screen  
 NEC JB 1201M with non reflecting matt screen and audio facility £90  
 Sanyo DM8112CX £99.00  
 (RGB lead £6.50: BNC lead £3.50) Carr. £7.00/monitor.

## EPROM PROGRAMMER

A fully self-contained Eprom programmer with its own power supply, able to program 2516, 2716/32/32A/64/128 single rail Eproms.

- \* Personality selection is simplified by a single rotary switch.
  - \* Programming voltage selector switch is provided with a safe position.
  - \* Warning indicator to show programming in progress.
  - \* Programmer can read, blank check, program and verify at any address/addresses on the EPROM.
  - \* Simple menu driven software supplied on cassette (transferable to disc)
  - \* Full editor with ASCII disassembler.
- Programmer complete with cables, software and operating instructions: £79.50 + £2 p&p.

## PRODUCTION EPROM PROGRAMMER Type P8000

It will blank check, copy and verify up to 8 Eproms at a time. Eprom types 2716 to 27128 can be selected by a single rotary switch.  
 £695 + £6 carriage.

**EPROMS: 2764 £5 27128 £16**  
**PHONE FOR BULK PRICES**

## EPROM ERASERS

UV1T Eraser with a built-in timer and mains indicator. Built-in safety interlock to avoid accidental exposure to the harmful UV rays. It can handle up to 5 eproms at a time with an average erasing time of about 20 mins. £59 + £2 p&p.  
 UV1 as above but without the timer £47 + £2 p&p.

## REAL-TIME CALENDAR/CLOCK

A low cost unit, that opens up the total spectrum of Real-Time applications. With its full battery backup, possibilities include an Electronic Diary, automatic document dating, precise timing & control in scientific & recreational fields etc. Simply connects via the User Port—No ROMs. Supplied with extensive applications software. £29+£2 p&p. (phone or write for details).

## BBC WORD PROCESSOR PACKAGE

BBC Word Processor Package is set up ready for you to write your text. There is no need for any extras. The package comprises of a BBC computer fitted with disc interface and View word processor rom, NEC PC8023 BE-N printer, View/NEC printer driver, high res green screen monitor and either a 100K single disc drive or a 800K dual disc drive. The system comes complete with all the connecting cables, manuals, three blank discs and 100 sheets of paper.

BBC WORD PROCESSOR SYSTEM with 100K Drive £999  
 BBC WORD PROCESSOR SYSTEM with 800K Drive £1400  
 Carriage only £8.00 per system.



## SIDEWAYS ROM EXPANSION BOARD

This board provides 8 additional sockets for expanding the computer's sideways ROM capacity by a further 128K. (2764s consume 40mA on standby and in our opinion 8 ROMs will not overload the computer psu). The board is dimensioned ensuring clearance of components with adequate ventilation.

Fully assembled and tested board with fitting instructions: With TI sockets £25. With Turned pin sockets £30 + £2 p&p.

**ADVANCED USER GUIDE**  
 £12.95 + £1.55 pp  
 Now Available

## BBC BOOKS

(No VAT on books p&p £1.00/Bk)

*ASSEMBLY LANGUAGE PROGRAMMING FOR THE BBC - BIRNBAUM	£8.95	FUNCTIONAL FORTH ON BBC MICRO	£5.95
BBC FORTH	£7.50	BBC MICRO - AN EXPERT GUIDE	£6.95
BBC LISP	£7.50	ADVANCED GRAPHICS FOR THE BBC MICRO	£7.95
BPCL MANUAL	£15.00	*ADVANCED PROGRAMMING TECHNIQUES FOR THE BBC MICRO	£7.95
35 EDUCATIONAL PROGRAMS FOR THE BBC MICRO - MURRY	£6.95	ASSEMBLY LANGUAGE PROGRAMMING FOR THE BBC MICRO (FERGUSON & SHAW)	£7.95
DISCOVERING BBC MICRO MACHINE CODE - STEPHENSON	£6.95	*6502 ASSEMBLY LANGUAGE PROGRAMMING (LEVENTMAL)	£12.10
INTRODUCTION THE BBC MICRO - SINCLAIR	£5.95	*PROGRAMMING THE 6502 (ZAXS)	£10.95
EASY PROGRAMMING FOR THE BBC MICRO - BEESON	£5.95	STRUCTURED BASIC ON BBC	£7.95
FURTHER PROGRAMMING FOR THE BBC MICRO - THOMAS	£5.95	SOUND & GRAPHICS ON BBC	£7.95
LET YOUR BBC TEACH YOU TO PROGRAM	£6.95		
THE FRIENDLY COMPUTER BOOK	£4.50		

\*p&p £1.50

Please send SAE for our detailed price list of electronic and computer components.

We carry a wide range of connectors and assemblies, Microprocessors, RAMs, EPROMs, Crystals, etc. Price Lists, Leaflets available on request. Large stocks enable same day despatch on most orders. Please check for delivery details.

PLEASE ADD 50p p&p & 15% VAT

(Export: no VAT, p&p at Cost)

Orders from Government Depts. & Colleges etc. welcome.



Detailed Price List on request

Stock items are normally by return of post.



## TECHNOMATIC LTD

MAIL ORDERS TO: 17 BURNLEY ROAD, LONDON NW10 1ED  
 SHOPS AT: 17 BURNLEY ROAD, LONDON NW10  
 (Tel: 01-452 1500, 01-450 6597. Telex: 922800)  
 305 EDGWARE ROAD, LONDON W2



# BBC MICRO <sup>IN</sup> MANCHESTER

ALL PRICES ARE MOVING CONSTANTLY SO  
WE STRONGLY ADVISE YOU TO

## RING FOR LATEST PRICES

## C ★ TECH

COMPUTERS

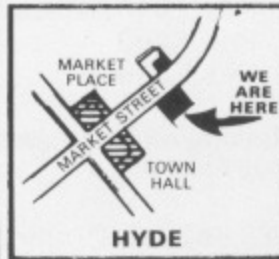

184 Market Street,  
Hyde,  
Cheshire SK14 1EX

ALL PRICES INCLUDE VAT UNLESS STATED OTHERWISE

061-366 8223

### BBC MODEL £499

# C

includes  
All MODEL B features plus  
WORDPROCESSOR + DISK INTERFACE  
Normally an extra £150

BBC MODEL B **£399**  
BBC MODEL B with Diskinterface **£469**

Free  
cassette  
leads  
worth  
£3.50

ELECTRON **£199**  
The latest Acorn home computer

Acorn add ons include VAT and fitting where applicable

Disk Interface	<b>£89.95</b>	Speech Synthesiser	<b>£54.95</b>
A→B Upgrade	<b>£69.95</b>	16K RAM for Model A	<b>£24.95</b>
Double Density	<b>£79.95</b>	Model B→C Upgrade	<b>£135.95</b>

All our Printers include VAT, Cable for BBC Micro and 2,000 sheets of paper worth £25

### STAR DP510

Our top selling printer, incredible value, 132 characters width max, 40 min, 5 print modes, plus 5 print modes in italics.  
User defined Graphics and Screen Dumps easy!  
Fantastic Glossy Manual, 100 CPS print speed, 2.3K Buffer, Typewriter Ribbon, Screen Dump free! RING FOR YOURS TODAY

**£289**

### JUKI

DAISYWHEEL  
At last a **high quality**  
Daisywheel. 18 CPS,  
Bidirectional, 10, 15, 12  
and proportional spacing,  
takes IBM ribbons, takes  
100 daisywheels

**£449**

### AP100

DOT MATRIX  
30 CPS, 80 cols, 40 cols,  
Graphics and Screen  
Dumps.  
Good value Dot Printer

**£189**

All our Disk Drives include VAT, Cables, Box, Formatting Disk and Manual worth £45

### TEAC 55A 10DK SLIMLINE

Single Slimline, high reliability, we've sold 350 and no problems YET!  
Our best selling drive and backed by the worlds leading manufacturer.

**£189**

### THE BIG ONE TEAC 55F SLIMLINE

Amazing value, Disk Drive, 400K Single Density, 800K Double Density

**£259 = 1MB**  
(MAXIMUM)

### ACORN/LVL

#### SHUGART SA SLIMLINE

Twin 100K, fast, quiet and full Acorn/LVL documentation. Top Value.  
TWIN

**£389**

LOADS OF BBC & ELECTRON SOFTWARE RING 061-366 8223



# YOUR PARENTS DID THEIR BEST FOR YOU... WILL YOUR CHILDREN BE ABLE TO SAY THE SAME?



"Now...I've got two oranges in my left hand and one in my right, how many oranges...?"

IN THE LAST FIVE YEARS, THE MICROCHIP HAS EXTENDED ITS REVOLUTIONISING INFLUENCE TO OUR SCHOOLS. TODAY, EVEN THE YOUNGEST CLASSES TAKE COMPUTERS AS MUCH FOR GRANTED AS WE DID OUR WOODEN RULERS.

WITH THESE IMPLICATIONS IN MIND, GOOD HOUSEKEEPING SOFTWARE WAS CREATED, ITS AIM BEING TO DEVELOP A COMPREHENSIVE RANGE OF CAREFULLY STRUCTURED EARLY LEARNING SOFTWARE FOR YOUR HOME COMPUTER.

A NEW WAY TO  
PLAY AND LEARN  
DESIGNED NOT  
JUST BY SOFTWARE

SPECIALISTS, BUT ALSO BY EDUCATIONAL EXPERTS, EACH PACKAGE GOES FAR BEYOND THE POPULAR IMAGE OF COMPUTER ASSISTED LEARNING.

IT PROVIDES A FRAMEWORK FOR YOU AND YOUR CHILD TO LEARN AND PLAY TOGETHER. IT ALSO ENCOURAGES YOUR CHILD TO DISCOVER THE REWARDS OF INDEPENDENCE AND CONCENTRATION AS HE OR SHE EXPLORES THE PROGRAM ALONE, OR WITH A FRIEND.

EACH PACKAGE INCLUDES GAMES. BUT UNLIKE MOST OTHER SOFTWARE FOR CHILDREN, THESE ARE NEITHER TRIVIAL NOR COMPETITIVE. THEY ARE DESIGNED TO ENCOURAGE LEARNING THROUGH STRUCTURED PLAY, COLOURFUL EYE-CATCHING GRAPHICS OF THE HIGHEST QUALITY, AND A VARIETY OF REALISTIC SOUND EFFECTS.

YOU CAN ALSO ADJUST THE SPEED AND DIFFICULTY OF EACH GAME TO SUIT YOUR CHILD. OR LET THE COMPUTER ADJUST ITSELF AUTOMATICALLY AS YOUR CHILD PROGRESSES.

## LEARNING WITH MR T

MR T, GOOD HOUSEKEEPING'S LIVELY ANIMATED CHARACTER, WILL HELP YOUR CHILDREN EXPLORE ALL SORTS OF

PREVIOUSLY DIFFICULT EDUCATIONAL AREAS. NOW THEY CAN LEARN TO TELL THE TIME, OR COPE WITH REAL MONEY, IN AN EXCITING AND ENTERTAINING WAY.

MR T WILL ALSO HELP YOUR CHILDREN COME TO TERMS WITH THE WHOLE IDEA OF COMPUTERS AS AN INTEGRAL PART OF THEIR FUTURE LIVES.

## THE PARENTS' HANDBOOK

A PARENTS' HANDBOOK IS INCLUDED IN EACH PACKAGE, CONTAINING SIMPLE OPERATING INSTRUCTIONS AND A STEP-BY-STEP GUIDE TO HELP YOU AND YOUR CHILD GET THE BEST OUT OF EACH PROGRAM. IT ALSO CONTAINS A WEALTH OF FOLLOW-UP ACTIVITIES FOR YOU BOTH TO ENJOY AWAY FROM THE COMPUTER.

## YOUR CHILDREN'S FUTURE BEGINS HERE

PUT YOUR HOME COMPUTER TO WORK FOR YOUR CHILDREN NOW. SEND FOR YOUR GOOD HOUSEKEEPING EARLY LEARNING PACKAGES BY CUTTING THIS COUPON.

HARDWARE COMPATIBILITY: BBC MICRO B 10.5 1.0 OR ABOVE; SINCLAIR SPECTRUM 48K, DRAGON AND COMMODORE 64. AVAILABLE AT LEADING COMPUTER STORES AND SPECIALIST COMPUTER DEPARTMENTS OF MAJOR HIGH STREET RETAILERS.



TO: EBURY SOFTWARE, 72 BROADWICK STREET, LONDON W1V 2BP.  
PLEASE SEND ME THE GOOD HOUSEKEEPING SOFTWARE PACKAGE(S) THAT I HAVE INDICATED.

		BBC MICRO B (O.S. 1.0 OR ABOVE)	SINCLAIR SPECTRUM 48K
MR T TELLS THE TIME	£12.95 EACH		
MR T'S MONEY BOX	£12.95 EACH		
MR T'S ALPHABET GAMES 4	£12.95 EACH		AVAILABLE 1984
MR T'S NUMBER GAMES	£12.95 EACH		
MR T'S MEASURING GAMES	£12.95 EACH		
MR T'S SHAPE GAMES	£12.95 EACH		
TOTAL			

DRAGON AND COMMODORE 64, VERSIONS AVAILABLE 1984.

I ENCLOSE MY CHEQUE/PO. FOR THE AMOUNT ABOVE INCLUDING VAT AND P&P, MADE PAYABLE TO EBURY SOFTWARE. OR CHARGE MY ACCESS/VISA/DINERS/AMERICAN EXPRESS.

A/C NO. \_\_\_\_\_

SIGNED \_\_\_\_\_ DATE \_\_\_\_\_

NAME MR/MRS/MS (BLOCK LETTERS) \_\_\_\_\_

ADDRESS \_\_\_\_\_

TOTAL NUMBER OF PACKAGES ORDERED \_\_\_\_\_

REMITTANCE SHOULD BE MADE PAYABLE TO EBURY SOFTWARE AND SHALL BE HELD ON YOUR BEHALF IN THIS ACCOUNT UNTIL THE GOODS ARE DESPATCHED. PLEASE ALLOW UP TO 28 DAYS FOR DELIVERY. OFFER APPLIES TO U.K. AND EIRE ONLY.

EBURY SOFTWARE (A DIVISION OF THE NATIONAL MAGAZINE CO LTD)  
REGISTERED NUMBER: 112955.

# GOOD HOUSEKEEPING SOFTWARE · EARLY LEARNING

PUBLISHED BY EBURY SOFTWARE (A DIVISION OF THE NATIONAL MAGAZINE CO LTD) FOR GOOD HOUSEKEEPING, NATIONAL MAGAZINE HOUSE, 72 BROADWICK STREET, LONDON W1V 2BP.



Your choice is crystal clear

## 'The Hobbit'

The Hobbit floppy tape system is the ideal alternative to an unreliable cassette recorder and an expensive disc drive.

This is a professional digital recorder designed specifically for users of micro computers.

The Hobbit is completely under the control of your computer - no more pressing RECORD/PLAY/FAST FORWARD, etc.

Absolutely no danger of accidentally overwriting other files on the cassette. The Hobbit uses an internal filing system similar to that used by a disc, thus ensuring that there is no redundant space on your cassettes.

The Hobbit is significantly faster than an ordinary cassette recorder (READ/WRITE speed 6000 data bits/sec., ordinary cassette recorder average 960 data bits/sec.)

Typical file access time is 22 seconds; maximum is 90 seconds.

Up to 5 files may be opened simultaneously. Random access files are fully supported.

Two Hobbits may be connected to your computer to form a dual drive system.

**NO COSTLY DISC INTERFACE REQUIRED**

No hidden extras - the Hobbit comes complete with everything you need, including one certified digital cassette.

The Hobbit is available now for BBC and NASCOM computers.

### Special Features for the BBC

**Zero Memory Option** The standard Hobbit operating chip sets PAGE to 1C00. With the Zero Memory Option the Hobbit does not use any of your precious RAM, thus making the transfer of programs from ordinary cassette to Hobbit even simpler.

**Power Supply** Power is taken from the external power outlet socket on the BBC computer. If your computer is not fitted with this socket a suitable power supply is available from us.

### Special Features for the NASCOM

**Microsoft Basic Upgrade Kit** Enables you to read and write files from BASIC using PRINT and INPUT statements - no more PEEKS and POKES! Supplied on a Hobbit cassette.

Operating system available in 2 x 2708 or 1 x 2716.

Normal address D000 - other addresses are available on request at no extra charge.

If you want to know more about the Hobbit before you make up your mind send to the address below for more details, or order the manual and see just how sophisticated the Hobbit really is.

If you have a different make of computer, but are interested in the Hobbit system, send us a stamped addressed envelope and details of your computer so that we can send you advance information of new products when they become available.



Available from most good computer shops or direct from:- IKON COMPUTER PRODUCTS, KILN LAKE, LAUGHARNE, DYFED.  
Tel. 099 421 515. BBC Hobbit £135.00 + £3.00 p&p. BBC Second drive £120.00 + £3.00 p&p. Zero Memory Option £25.00 (£18.00 if ordered with the Hobbit). Power Supply £12.00. Manual (ordered separately) £1.50 (No VAT; refundable on purchase of Hobbit). Nascom Hobbit (unboxed) £120.00. Nascom second drive £94.00. Basic Upgrade Kit £10.00. Box of 6 cassettes £17.50. Cleaning cassette £3.50. Please add VAT at the current rate to the above prices.  
ACCESS AND VISA ACCEPTED.

**IKON**

COMPUTER PRODUCTS



## Looney Lift



# H & H SOFTWARE PRESENTS 3 NEW TAPES for the BBC 32K COMPUTER

to add to their existing range of games and educational software.

### LOONEY LIFT

A new action packed arcade game with hi-res graphics, full colour and sound. Keep your guests jumping, operate the lift and watch out for the luggage. The alternative is the sack!

£7.50

### CHEMIPLANT

Another first? A chemical plant simulation. Avoid explosions, spills and other disasters on your way to your first million. Plant manual included. Hi-res graphics.

£7.50

### STORY

Electronic storytelling! First make up some scenes using pictures from the computer bank or use your own drawing skills. Then write your story. Up to 7 screens can be displayed, saved and printed.

£6.50

To get more information about our new and existing software, ask for a catalogue. Please send a s.a.e.

\*\*\* Disc versions available: please add £1.50 \*\*\*

Please send orders and cheques/PO to:

**H & H Software, Dept M, 53 Holloway,  
Runcorn, Cheshire WA7 4TJ. Tel: 09285  
65566**

# WALTERS TAKE ANOTHER BYTE



WALTERS NEW  
STACK-A-DRIVE  
GIVES YOU THE

BEST IN DISC DRIVE TECHNOLOGY,  
PLUS A UNIQUE IDEA . . .

Walters and Teac have combined to give you the best disc drive.  
You can buy your first now and later just STACK another!  
And no more cables to purchase either!

## FULL 1 YEAR WARRANTY

- |                                    |                 |         |
|------------------------------------|-----------------|---------|
| ① 100K, 40 track Single Side Pack  | £181.00 + VAT = | £208.15 |
| ② 400K, 80 track Double Sided Pack | £299.00 + VAT = | £343.85 |
- Use them in any configuration, but remember your BBC will only support 4 surfaces. For example an 800K dual configuration would cost just

£598.00 + VAT = £687.70

### OPTIONAL EXTRAS

- |  |                              |        |
|--|------------------------------|--------|
| ③ Universal Cable Set (takes both SINGLE and DUAL configuration) | £11.50 + VAT =               | £13.22 |
| ④ Disc utilities and manual                                      | £15.00 + VAT =               | £17.25 |
| Delivery, including insurance                                    | £4.50 for single + VAT =     | £5.17  |
|  | £7.50 for two drives + VAT = | £8.62  |

## PRE-CHRISTMAS OFFER!

100K £10.00 OFF = **£11.50 INC. VAT**  
400K £19.00 OFF = **£21.85 INC. VAT**  
800K £38.00 OFF = **£43.70 INC. VAT**

All orders received prior to 1st December, 1983.

Further information about this exciting new idea or details of our complete range of BBC accessories and peripherals may be obtained by phoning us on Stourbridge (03843) 70811.

**WALTERS COMPUTER SYSTEMS LTD.**  
12 HAGLEY ROAD, STOURBRIDGE, WEST MIDLANDS DY8 1PS  
TEL: STOURBRIDGE (03843) 70811 (9 LINES)

*Get it Right!*

DEALER  
ENQUIRIES  
WELCOME

RUSH ME AN ORDER FORM

Name \_\_\_\_\_

Address \_\_\_\_\_



Forget  
Cassettes

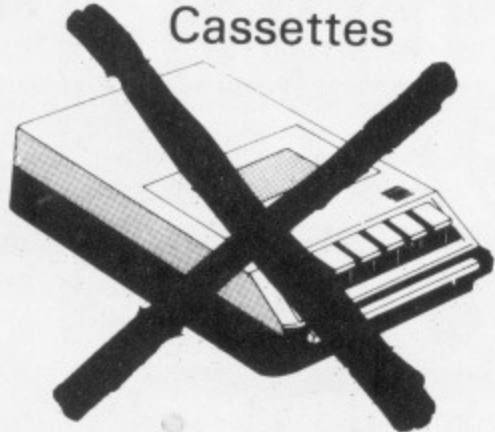

REMEMBER  
Disc Drives

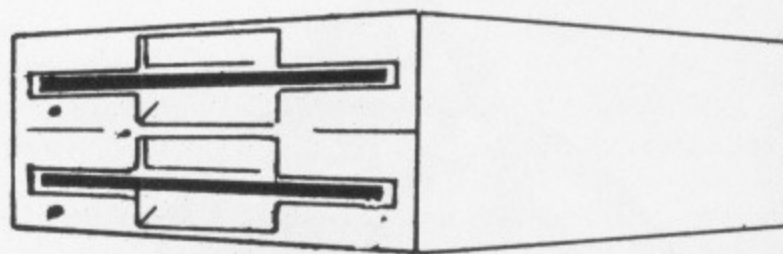

There's only one IMPORTANT name in  
Specially Designed Computer Supplies

# Viglen

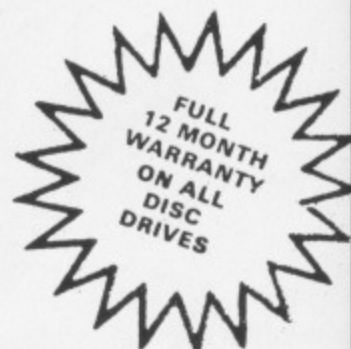

**TEACS 55 Series Slimline Drives**

<b>Single Drives</b>	<b>ex. VAT</b>	<b>inc. VAT</b>
★ 40 Track 100K	£144.35	<b>£166.00</b>
★ 40/80 Track Switchable 200K	£173.05	<b>£199.00</b>
★ 40/80 Track Switchable 400K	£223.48	<b>£257.00</b>
<b>Dual Drives</b>		
★ 40 Track 200K	£278.26	<b>£320.00</b>
★ 40/80 Track Switchable 400K	£359.57	<b>£402.00</b>
★ 40/80 Track Switchable 800K	£452.18	<b>£520.00</b>

**Mitsubishi Drives**

★ 800K	£379.00	<b>£435.85</b>
★ 800K + PSU	£399.00	<b>£458.85</b>
★ Disc Filing System	£65.22	<b>£75.00</b>
★ Power Supply Unit	£28.00	<b>£32.20</b>

ALL PRICES INCLUDE LEADS, CASE AND HARDWARE SWITCH (where applicable) - READY TO USE.

**Free** Disc Formatter and Manual. Please add £8 for Special Delivery and packing.

**NO HIDDEN EXTRAS**

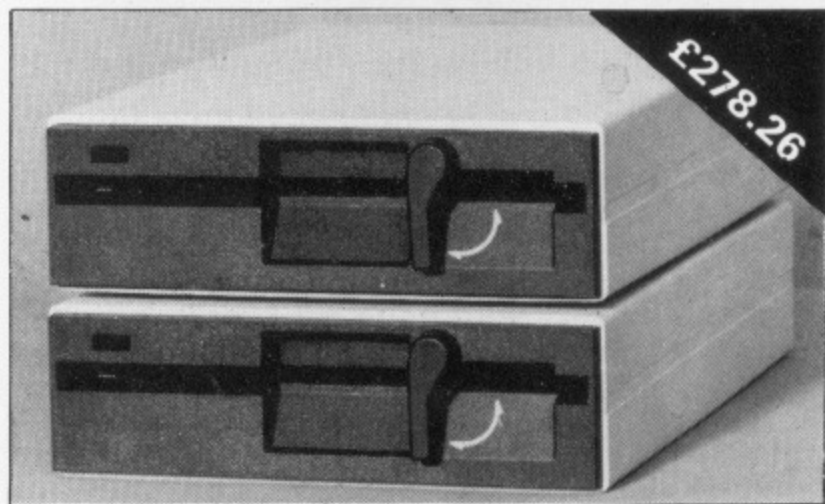
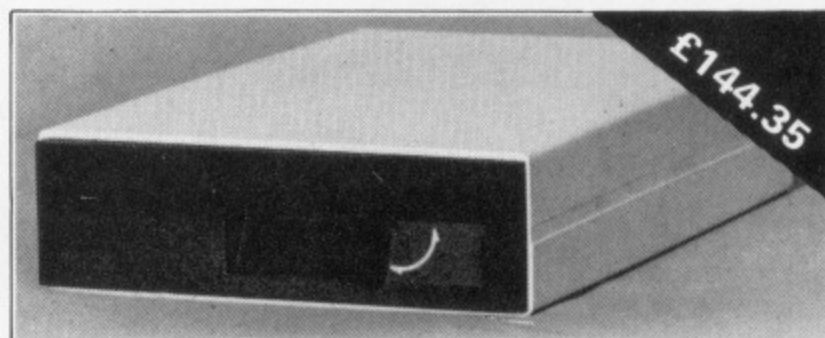

Please enquire about **SPECIAL DELIVERY** within 48 hours.

Complete order form and send together with cheque or postal order made out to:

**VIGLEN COMPUTER SUPPLIES,  
Unit 7, Trumpers Way,  
Hanwell W7 2QA.**

Or phone in order with  
B/card or Access No.



**01-843 9903**

**ORDER FORM**

Please supply .....

Type and make of drive .....

Quantity .....

I enclose cheque/PO for .....

My Access/Barclaycard No. ....

.....

Name .....

Address .....

.....

MU5

Educational establishment orders welcomed.



# OUT NOW! 811 IDEAS FOR YOUR COMPUTER

NEW  
SAME-DAY  
DELIVERY  
IDEAS  
BOOK

In the Inmac catalogue of ideas for your computer check to see what is in the latest issue for you:

**Cables, cables and more cables!** How to order custom-built cables. When to use screened cables. How to choose the right EIA RS-232 extension cables for your VDU's and how to connect your Apple, Commodore, or other micros to Qume, Diablo, NEC printers. Compatible cables for connecting new peripherals to your DEC, Data General, Hewlett Packard, IBM, Osborne and Tandy computers.

**Lifetime Floppies** Read about Inmac Plus — the floppy with a lifetime guarantee! Choose from our range of 100% error-free disk cartridges, flag-free disk packs,

each with a 3-year replacement guarantee.

**New Ideas!** Dozens of exciting new products — many never seen in Europe before now — and lots of helpful hints on getting more from your computer department.

**Service and Quality — a promise you can rely on!** We promise a next day delivery service of our products, a 30-day risk-FREE trial, and a 12-month trouble-free quality replacement guarantee.

Send today for your FREE catalogue with no obligation to purchase — but be warned: you will want to buy once you have read the Inmac catalogue ideas book!



**FREE!** IF YOU USE A COMPUTER  
☎ 09285-67551/01 740 9450

Send this coupon to Dept.415, Inmac (UK) Limited, Davy Road, Astmoor, Runcorn, Cheshire WA7 1PZ.

Name \_\_\_\_\_

Company \_\_\_\_\_

Address \_\_\_\_\_

24 hour tel. no.

☎ 09285-67551



# The best thing next



The BBC Model B microcomputer is widely recognised as an impressive first computer for the home or the school, but its capabilities are restricted by its lack of data storage and the limitations of Basic for serious programming. For the user who needs more from this computer the Torch Z80 Disc Pack is a gateway to the world of advanced computing.

The Torch Z80 Disc Pack will upgrade your Model B micro to a full business machine, offering the use of more powerful and flexible languages such as Fortran, Pascal, BCPL and Cobol, while twin 400K disc drives provide a massive storehouse for information and rapid data transfer from disc to processor.

The Disc Pack includes a second processor - the proven and reliable Z80 which powers Torch's highly acclaimed C-series business computer. The Z80 co-operates with the Model B's own 6502 chip, delegating screen and peripheral handling to provide faster access speeds than any other comparable disc drive system.

In addition to accepting the BBC's extensive range of software, the Z80 Disc Pack supplies Torch's own CP/M®-compatible Network operating system, based in Read Only Memory (ROM). This advanced design means that almost all of the 64K of Random Access Memory (RAM) provided on the Z80 board is available for CP/M programming use - an advantage that no other BBC micro upgrade can offer.

If your BBC micro has the Econet® option, there is a further benefit the Z80 Disc Pack can provide. Torchnet can link together up to 254 upgraded Model B's on a local area network, so for enthusiasts' clubs and schools it is a simple and low-cost way to set up a local area network.

At only £730\*, including installation at your dealer, the Torch Z80 Disc Pack offers real value for money. It is supplied with an impressive package of software including the PERFECT® range of business software comprising Perfect Writer (word processing) Perfect Filer (database management) and Perfect Calc (advanced, powerful spreadsheet). Add to that COMANEX®, the interactive management game, approved and used by leading Management Consultants - and you have a software package valued at over £1,000.

The Torch Z80 Disc Pack is a proven and cost-effective way of increasing the computing power of your BBC Model B micro, so if you are ready to take a step into the world of serious computing, contact your local dealer, listed on the facing page.

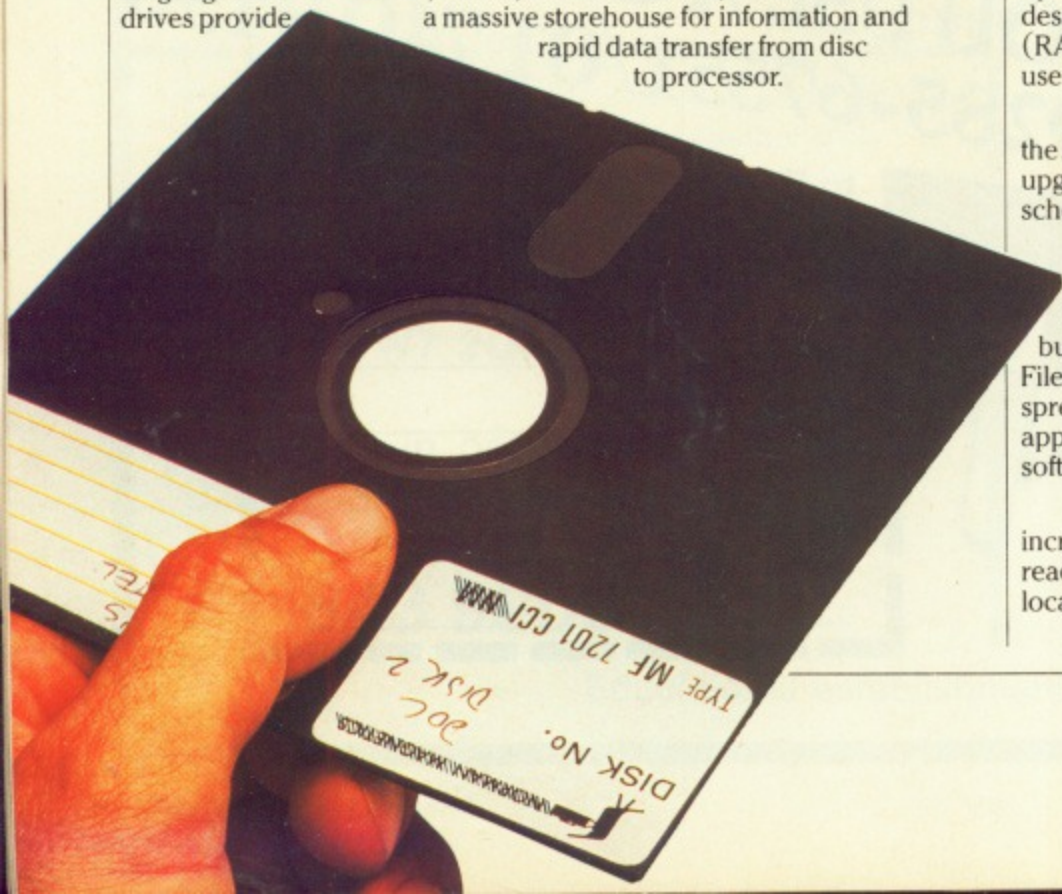



# Next to a BBC micro.

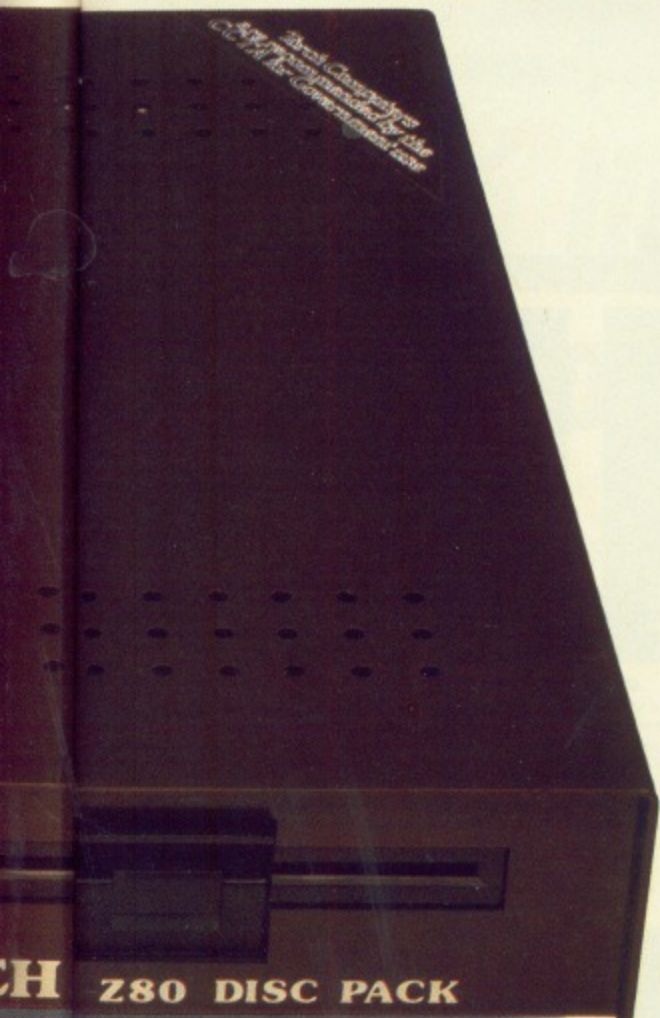

**TORCH Z80 DISC PACK**

**Torch Z80 Disc Pack. Technical Specification.**  
 4MHz Z80 Application processor · 64K RAM · 16K ROM · Torch MCP (8K CP/M compatible operating system with Networking in firmware) · Disc interface lead · 2MHz BUS lead for Tube socket · Low voltage PSu output · Perfect Software comprising: 1. Perfect Writer - word processing · 2. Perfect Filer - database management · 3. Perfect Calc - financial spreadsheet · 4. Perfect Speller - spelling checker · Comanex® - interactive management gain · Torch CPN CP/M compatible O/S disc utilities (Pokedisc, Mapdisc) music system (Muscmpx, Music) · Miscellaneous utilities (Font, RdAcorn, Torchbug etc)  
 2 400K (formatted) floppy disc drives  
 UCSD p-system available from I.S.V. Languages available Cobol, Fort, Fortran, Lisp, Pascal, Pilot, Basic, Prolog, BBC Basic (Z80), BCPL, C(Z80)  
 Torch Computers Limited, Abberley House Great Shelford, Cambridge CB2 5LQ  
 Telephone: (0223) 841000  
 Telex 818841 TORCH G.

\*RRP £730 ex VAT.

**TORCH COMPUTERS**  
 Lighting the way ahead.

## Where to find your Torch dealer

- |   |  |  |   |  |
|---|--|--|---|--|
| <p><b>AVON</b><br/> <b>AVON COMPUTER RENTALS</b><br/>         8 Eastbury Close, Thornbury Bristol<br/>         Tel: 0454 415460<br/> <b>CCE EUROPE LTD</b><br/>         10 Somerset Avenue, Yate, Bristol<br/>         Tel: 0454 321088<br/> <b>JADE COMPUTERS</b><br/>         Combond, Radstock<br/>         Tel: 0761 36397<br/> <b>BEDFORDSHIRE</b><br/> <b>BROADWAY ELECTRONICS</b><br/>         1 The Broadway Bedford<br/>         Tel: 0234 215639<br/> <b>DATASINE</b><br/>         59 North Street, Leighton Buzzard<br/>         Tel: 0525 374200<br/> <b>BERKSHIRE</b><br/> <b>COMPUTER PERIPHERAL SUPPLIES</b><br/>         Unit 20, Stadium Way<br/>         Battle Farm Trading Estate, Reading<br/>         Tel: 0734 418383<br/> <b>GOLEM LTD</b><br/>         77 Qualitas, Bracknell<br/>         Tel: 0344 507020<br/> <b>MICROSTYLE</b><br/>         Newbury Computer Centre<br/>         47 Cheap Street, Newbury<br/>         Tel: 0635 41929<br/> <b>P. J. MICROSYSTEMS</b><br/>         14 Woodend, Crowthorne<br/>         Tel: 0344 772351<br/> <b>WINDSOR COMPUTER CENTRE</b><br/>         1 Thames Road, Windsor<br/>         Tel: 07535 58077<br/> <b>BUCKINGHAMSHIRE</b><br/> <b>COMPUTER SYSTEMS ANALYSIS LTD</b><br/>         Europa House, Marsham Way<br/>         Gerrard Cross<br/>         Tel: 0753 885389<br/> <b>CHILDREN ELECTRONICS</b><br/>         High Street, Chalfont St. Giles<br/>         Tel: 02407 71234<br/> <b>TYPOS SYSTEMS LTD</b><br/>         Office 11, Spaceneal Centre, Coin Estate<br/>         733A Old Bath Road, Coin Brook<br/>         Tel: 02812 3753<br/> <b>CAMBRIDGESHIRE</b><br/> <b>ARDEN DATA PROCESSING LTD</b><br/>         166 Park Road, Peterborough<br/>         Tel: 0733 47767<br/> <b>CAMBRIDGE COMPUTER CONSULTANTS</b><br/>         124/126 Ross Street, Cambridge<br/>         Tel: 0223 210677<br/> <b>CAMBRIDGE COMPUTER STORE</b><br/>         1 Emmanuel Street, Cambridge<br/>         Tel: 0223 358264/85334<br/> <b>CONTROL UNIVERSAL</b><br/>         Unit 2, Andersons Court, Newnham Road<br/>         Cambridge<br/>         Tel: 0223 358757<br/> <b>HI-TEK DISTRIBUTION LTD</b><br/>         Trafalgar Way, Bar Hill, Cambridge<br/>         Tel: 0954 81931<br/> <b>HERALD COMPUTERS</b><br/>         93 East Road, Cambridge<br/>         Tel: 315622<br/> <b>CHESHIRE</b><br/> <b>FAIRHURST INSTRUMENTS LTD</b><br/>         Dean Court, Woodford Road, Wilmslow<br/>         Tel: 0625 525694<br/> <b>MARPLE COMPUTER CENTRE</b><br/>         30/32 Market Street, Marple, Stockport<br/>         Tel: 061 449 9933<br/> <b>MID-SHARES COMPUTER (SERVICES) LTD</b><br/>         78 Nantwich Road, Crewe<br/>         Tel: 0270 210865/211064<br/> <b>NATIONAL MICRO CENTRES LTD</b><br/>         Norbury House, Norbury Crescent<br/>         Hazel Grove, Stockport<br/>         Tel: 061 456 8500/9548<br/> <b>CLEVELAND</b><br/> <b>AUTOCALL COMPUTERS LTD</b><br/>         17 Middlesbrough Road, Southbank<br/>         Middlesbrough<br/>         Tel: 0642 468616<br/> <b>CUSTOMISED ELECTRONICS</b><br/>         155 Morton Road, Middlesbrough<br/>         Tel: 0642 247727<br/> <b>CORNWALL</b><br/> <b>MICROTEST LTD</b><br/>         18 Normandy Way Bodmin<br/>         Tel: 0208 3171<br/> <b>DERBYSHIRE</b><br/> <b>FBC SYSTEMS LTD</b><br/>         10 Main Centre, London Road, Derby<br/>         Tel: 0332 365280<br/> <b>DEVON</b><br/> <b>A &amp; D COMPUTERS</b><br/>         "Computerland", 6 City Arcade<br/>         Fore Street, Exeter<br/>         Tel: 0392 7717<br/> <b>COMPUTER SERVICES (SW) PLC</b><br/>         Millbay Road, Plymouth<br/>         Tel: 0752 668814</p> | <p><b>DEVON COMPUTERS LTD</b><br/>         The White House, 39 Totnes Road<br/>         Paignton<br/>         Tel: 0803 526303<br/> <b>DORSET</b><br/> <b>HUGH SYMONDS</b><br/> <b>COMPUTER SERVICES LTD</b><br/>         Lansdowne, 5 Holdenhurst Road<br/>         Bourne-mouth<br/>         Tel: 0202 20165<br/> <b>CO. DURHAM</b><br/> <b>DARLINGTON COMPUTER SHOP</b><br/>         75 Bonolgate, Darlington<br/>         Tel: 0325 487478<br/> <b>ESSEX</b><br/> <b>AKHTER INSTRUMENTS LTD</b><br/>         Unit 19, Arlinghside Estate, South Road<br/>         Templefields, Harlow<br/>         Tel: 0279 412639<br/> <b>CAPRICORN COMPUTER CENTRE</b><br/>         32 North Hill, Colchester<br/>         Tel: 0206 68471<br/> <b>CLACTON COMPUTER CENTRE</b><br/>         29-31 Pier Avenue, Clacton on Sea<br/>         Tel: 0255 422 644<br/> <b>EASTERN DATA PROCESSING LTD</b><br/>         Whiteclands, Hatfield Peverel, Chelmsford<br/>         Tel: 0245 380099<br/> <b>ESSEX COMPUTER CENTRE LTD</b><br/>         150 Moulsham Street, Chelmsford<br/>         Tel: 0245 358702<br/> <b>HESELING BUSINESS SYSTEMS</b><br/>         7 Cambridge House, Cambridge Road<br/>         Barking<br/>         Tel: 01-591 6111<br/> <b>GLOUCESTERSHIRE</b><br/> <b>COMPUTER SHACK</b><br/>         14 Pittville Street, Cheltenham<br/>         Tel: 0242 584343<br/> <b>HAMPSHIRE</b><br/> <b>AMECCO (HYDROSPACE) LTD</b><br/>         2 North Way, Walsworth Industrial Estate<br/>         Andover<br/>         Tel: 0264 58744/58699<br/> <b>ELECTRONQUIP</b><br/>         34/38 West Street, Fareham<br/>         Tel: 0329 230 670<br/> <b>FERRANTI AND CRAIG</b><br/>         5 New Market Sq., Basingstoke<br/>         Tel: 0256 52203<br/> <b>JOHN LANE SYSTEMS LTD</b><br/>         5A Charles Street, Peterfield<br/>         Tel: 0730 67221<br/> <b>NU DATA COMPUTER SYSTEMS</b><br/>         Unit 1, Mitchell Close, Fareham<br/>         Tel: 04805 83001<br/> <b>RMK ELECTRONICS LTD</b><br/>         Hinton House, Station Road, New Milton<br/>         Tel: 0425 61610<br/> <b>HERTS</b><br/> <b>COMPUTER PLUS</b><br/>         47 Queens Road, Watford<br/>         Tel: 0923 33927<br/> <b>HUMBERSIDE</b><br/> <b>THE COMPUTER CENTRE (HUMBERSIDE)</b><br/>         26 Anlaby Road, Hull<br/>         Tel: 0482 26297<br/> <b>HOLDENERS COMPUTER SERVICES</b><br/>         17 Westgate, Patrington, Nr Hull<br/>         Tel: 0964 30225<br/> <b>VIXON COMPUTER SYSTEMS LTD</b><br/>         49 Grimbsy Road, Cleethorpes<br/>         Tel: 0472 58561<br/> <b>ISLE OF MAN</b><br/> <b>ICA SERVICES LTD</b><br/>         11 Mount Hovelscot, Douglas<br/>         Tel: 0624 26548<br/> <b>TYPESTYLE LTD</b><br/>         1 Avonside Court, Orchan<br/>         Tel: 0624 24650<br/> <b>ISLE OF WIGHT</b><br/> <b>VECTIS COMPUTER SERVICES</b><br/>         40 Canbroske Road, Newport<br/>         Tel: 0983 528345<br/> <b>KENT</b><br/> <b>THE COMPUTER USERS CLUB</b><br/>         69 Hadlow Road, Welling<br/>         Tel: 01-311 2535<br/> <b>KENT MICROS LTD</b><br/>         57 Union Street, Maidstone<br/>         Tel: 0622 52784<br/> <b>KENT MICRO SYSTEMS</b><br/>         Conquest House, 17 Palace Street<br/>         Canterbury<br/>         Tel: 0227 50200/50386<br/> <b>PATHLINE LTD</b><br/>         19 King Street, West Malling, Maidstone<br/>         Tel: 0732 848477<br/> <b>PRESTEDGE ASSOCIATES LTD</b><br/>         988 Canterbury Road, Margate<br/>         Tel: 0843 32616<br/> <b>LANCASHIRE</b><br/> <b>THE BYTE SHOP (MANCHESTER) LTD</b><br/>         11/12 Gateway House, Piccadilly Station<br/>         Approach, Manchester<br/>         Tel: 061 236 4737</p> | <p><b>DOUBLELINE LTD</b><br/>         Unit 2, Forrest Way, Gateworth Industrial<br/>         Estate, Great Sankey, Warrington<br/>         Tel: 0925 573212<br/> <b>IMO (BUSINESS SYSTEMS) LTD</b><br/>         39-43 Standish Street, Burnley<br/>         Tel: 0282 54299<br/> <b>MERIT COMPUTERS</b><br/>         Unit 4, Caroline Street, Wigan<br/>         Tel: 0942 495821<br/> <b>NORTHERN COMPUTERS</b><br/>         Churchfield Road, Frodsham, Warrington<br/>         Tel: 0928 35110<br/> <b>NSC COMPUTER SHOPS</b><br/>         2A Hanging Ditch, Manchester<br/>         Tel: 061 832 2269<br/> <b>LEICESTERSHIRE</b><br/> <b>PERCY LORD &amp; SON</b><br/>         63 Blaby Road, Wigston<br/>         Tel: 0535 785033<br/> <b>R H MURCOTT LTD</b><br/>         Great Central Rd., Loughborough<br/>         Tel: 0509 254444<br/> <b>LINCOLNSHIRE</b><br/> <b>COMPUT A CROP</b><br/>         3 Commarket, Louth<br/>         Tel: 0507 804271<br/> <b>FELIX COMPUTERS</b><br/>         63 Wide Bargate, Boston<br/>         Tel: 0205 54321<br/> <b>OAKLEAF COMPUTERS LTD</b><br/>         121 Dudley Road, Grantham<br/>         Tel: 0476 76994<br/> <b>LONDON AND GREATER LONDON</b><br/> <b>AUDITRONIC SYSTEMS LTD</b><br/>         78 Buckingham Gate, SW1<br/>         Tel: 01-222 2615<br/> <b>BAINBRIDGE COMPUTERS LTD</b><br/>         78 Green Street, E7<br/>         Tel: 01-471 33350<br/> <b>BRAINSTORM COMPUTER SOLUTIONS</b><br/>         103A Seven Sisters Road, N7<br/>         Tel: 08-272 8693/263 6926<br/> <b>CHROMASONIC</b><br/>         48 Junction Road, Archway, N19<br/>         Tel: 01-263 9483<br/> <b>COMPUTALINE</b><br/>         14-16 Oxford Circus Avenue<br/>         231 Oxford Street, W1<br/>         Tel: 01-434 4017<br/> <b>COMPSHOP LTD</b><br/>         14 Station Road, New Barnet<br/>         Tel: 01-441 2922<br/> <b>HARRISON ASSOCIATES LTD</b><br/>         Unit 307, 16 Brune Street, E1<br/>         Tel: 01-377 9630<br/> <b>ICT LTD</b><br/>         76 Cannon Street, EC4<br/>         Tel: 01-248 8895<br/> <b>INTERAM COMPUTER SYSTEMS LTD</b><br/>         46 Batham High Road, SW12<br/>         Tel: 01-875 5325<br/> <b>LION HOUSE (RETAIL) LTD</b><br/>         227 Tottenham Court Road, W1<br/>         Tel: 01-580 7383<br/> <b>OFF RECORDS</b><br/>         Computer House, 59 Battersea Rise, SW11<br/>         Tel: 01-223 7730<br/> <b>PERMEX LTD</b><br/>         Lodge House, Lodge Road, NW4<br/>         Tel: 01-203 4243<br/> <b>REW VIDEO PRODUCTS LIMITED</b><br/>         118 Garratt Lane, SW18<br/>         Tel: 01-870 9911<br/> <b>SILICON VALLEY COMPUTER CENTRE (GROUP 18 LTD)</b><br/>         Suite 104/105, 16 Baldwins Gardens, EC1<br/>         Tel: 01-242 2893<br/> <b>STEIGER COMPUTERS LTD</b><br/>         Steiger House, North Circular Rd<br/>         Stonebridge Park, NW10<br/>         Tel: 01-961 6000<br/> <b>TECHNOMATIC LTD</b><br/>         17 Burnley Road, NW10<br/>         Tel: 01-452 1500/450 6597<br/> <b>TRIGON OFFICE SERVICES LTD</b><br/>         98 Victoria Road, NW10<br/>         Tel: 01-981 1466<br/> <b>THE VIDEO PALACE (MEGAVIDEO) LTD</b><br/>         100 Oxford Street, W1<br/>         Tel: 01-637 3366/7<br/> <b>MERSEYSIDE</b><br/> <b>DATA EXCHANGE</b><br/>         Exchange House, 164 New Chester Rd<br/>         Birkenhead<br/>         Tel: 051 647 9185<br/> <b>PLESSEY INFORMATION TECHNOLOGY CENTRE</b><br/>         Unit 9, Pengoill Works, Hawthorne Rd<br/>         Bootle, Liverpool<br/>         Tel: 051 933 3120<br/> <b>MIDDLESEX</b><br/> <b>MICRODAGE</b><br/>         105 Hale Lane, Edgware<br/>         Tel: 01-859 8411<br/> <b>SYSGO LTD</b><br/>         Hawkehouse, Green Street<br/>         Sunbury on Thames, Middlesex<br/>         Tel: 08327 89571<br/> <b>TWICKENHAM COMPUTER CENTRE</b><br/>         72 Heath Road, Twickenham<br/>         Tel: 01-891 1612</p> | <p><b>MIDLANDS (WEST)</b><br/> <b>COMPUTACOUNT</b><br/>         21 Spring Hill, Ladywood, Birmingham<br/>         Tel: 021 236 3455<br/> <b>PACEMAKER COMPUTING LTD</b><br/>         5th Floor, Scala House, Small Brook<br/>         Birmingham<br/>         Tel: 021 643 0544<br/>         P. S. B.<br/>         11 Bennetts Road, Washwood Heath<br/>         Birmingham<br/>         Tel: 021 328 7124<br/> <b>STARMER COMPUTERS LTD</b><br/>         Richmond House, 69 School Street<br/>         Wolverhampton<br/>         Tel: 0902 713173<br/> <b>WALTERS COMPUTER SYSTEMS</b><br/>         12 Hagley Road, Stourbridge<br/>         Tel: 03843 70811<br/> <b>NORFOLK</b><br/> <b>JARROLD OFFICE EQUIPMENT</b><br/>         Barrack Street, Norwich<br/>         Tel: 0603 680861<br/> <b>SYNERGY LTD</b><br/>         E Block, University Village, University of<br/>         East Anglia, Norwich<br/>         Tel: 0603 503015<br/> <b>NORTHAMPTONSHIRE</b><br/> <b>COMPUTERWORLD</b><br/>         19 Abington Square, Northampton<br/>         Tel: 0604 31861<br/> <b>DATABASE COMPUTERS</b><br/>         7 High Street, Irthlingborough<br/>         Tel: 0533 650133<br/> <b>DATALEAF LTD</b><br/>         63 Bradshaw Way, Irchester<br/>         Tel: 05334 50362<br/> <b>NOTTINGHAMSHIRE</b><br/> <b>G A COMPUTERS LTD</b><br/>         20-22 High Street, Ruddington<br/>         Tel: 0602 23492/21225<br/> <b>HN &amp; L FISHER (HUTHWAITE) LTD</b><br/>         264 Huthwaite Road, Sutton in Ashfield<br/>         Tel: 0623 553437<br/> <b>LEASALINK VIEWDATA</b><br/>         230-236 Derby Road, Stapleford<br/>         Tel: 0602 334000<br/> <b>SHROPSHIRE</b><br/> <b>COMPUTER VILLAGE LTD</b><br/>         Walker House, Telford Town Centre<br/>         Telford<br/>         Tel: 0957 506771<br/> <b>STAFFORDSHIRE</b><br/> <b>CABEL ELECTRONIC LTD</b><br/>         Mount Road, Burnwood, Walsall<br/>         Tel: 05430 2121<br/> <b>COMPUTERAMA</b><br/>         59 Foregate Street, Stafford<br/>         Tel: 0785 41899<br/> <b>PEN SPEED LIMITED</b><br/>         Wharf House, Fradley Junction, Alrewas<br/>         Burton on Trent<br/>         Tel: 0283 790338<br/> <b>SUFFOLK</b><br/> <b>BRAINWAVE MICROS LTD</b><br/>         24 Crown Street, Ipswich<br/>         Tel: 0473 50965<br/> <b>S. J. EMERY &amp; CO</b><br/>         10 Market Place, Bungay<br/>         Tel: 0866 2141<br/> <b>MICROMANAGEMENT</b><br/>         32 Princess Street, Ipswich<br/>         Tel: 0473 59181<br/> <b>SURREY</b><br/> <b>COMPUTAID LTD</b><br/>         No 1 Warehouse, Horley Row, Horley<br/>         Tel: 02934 72206<br/> <b>CROYDON COMPUTER CENTRE</b><br/>         29A Bngstock Road, Thornton Heath<br/>         Tel: 01-689 1280<br/> <b>3-D COMPUTERS</b><br/>         230 Talworth South, Surbiton<br/>         Tel: 01-337 4317<br/> <b>GUILDFORD COMPUTER CENTRE</b><br/>         1 The Quadrant, Bridge Street, Guildford<br/>         Tel: 0483 578838<br/> <b>J. S. SIMNETT COMPUTERS LTD</b><br/>         91 Acre Road, Kingston Upon Thames<br/>         Tel: 01-546 3793<br/> <b>KINGSTON COMPUTER CENTRE</b><br/>         59 Surbiton Road<br/>         Kingston Upon Thames<br/>         Tel: 01-549 9416<br/> <b>MISTER CALCULATOR (CCS) LTD</b><br/>         First Floor, 19 Park Street, Croydon<br/>         Tel: 01-686 9616<br/> <b>MODERN BUSINESS TECHNOLOGY</b><br/>         PO Box 87, Guildford<br/>         Tel: 04868 23956<br/> <b>P. J. EQUIPMENT LTD</b><br/>         3 Bridge Street, Guildford<br/>         Tel: 0483 578848<br/> <b>STATACOM LTD</b><br/>         234 High Street, Sutton<br/>         Tel: 01-611 2266<br/> <b>VITALPORT LTD</b><br/>         44 Radcliffe Road, Croydon<br/>         Tel: 01-654 5751<br/> <b>SUSSEX</b><br/> <b>C.J.E. MICROCOMPUTERS</b><br/>         78 Brighton Road, Worthing<br/>         Tel: 0903 213900</p> | <p><b>SOUTH EAST COMPUTERS LTD</b><br/>         Unit 2, Castleham Road, Hastings<br/>         Tel: 0424 426844<br/> <b>TYNE &amp; WEAR</b><br/> <b>HCCS</b><br/>         533 Durham Road, Low Fell, Gateshead<br/>         Tel: 0632 821924<br/> <b>QUALITY MICROPRODUCTS LTD</b><br/>         Victoria Buildings, 46 Grainger Street<br/>         Newcastle Upon Tyne<br/>         Tel: 0632 614646<br/> <b>WARWICKSHIRE</b><br/> <b>CARYELLS OF RUGBY</b><br/>         9 Bank Street, Rugby<br/>         Tel: 0788 65275<br/> <b>WILTSHIRE</b><br/> <b>BEEGREEN LTD</b><br/>         PO Box 174, Swindon<br/>         Tel: 0793 61455<br/> <b>WILTSHIRE MICRO CENTRE</b><br/>         47 Victoria Road, Swindon<br/>         Tel: 0793 612299<br/> <b>YORKSHIRE</b><br/> <b>BRADFORD OFFICE SUPPLIES CO</b><br/>         Colonial Buildings, 139 Sunbridge Road<br/>         Bradford<br/>         Tel: 0274 726783<br/> <b>COM-TEC</b><br/>         6 Eastgate, Bamsley<br/>         Tel: 0226 46972<br/> <b>DATRON MICROCENTRES</b><br/>         2 Abbeydale Road, Sheffield<br/>         Tel: 0742 585480/585400<br/> <b>ELECC COMPUTERS LTD</b><br/>         231 Manningham Lane, Bradford<br/>         Tel: 0274 491372<br/> <b>SUPERIOR SYSTEMS</b><br/>         178 West Street, Sheffield<br/>         Tel: 0742 755005<br/> <b>MICROPOWER</b><br/>         8/8A Regent Street, Chapel Allerton<br/>         Leeds<br/>         Tel: 0532 683186<br/> <b>WALES</b><br/> <b>CLWYD</b><br/> <b>TECHNEG CLWYD TECHNIS LTD</b><br/>         The Coach House, Keirsterton Road, Flint<br/>         Tel: 0244 910518<br/> <b>BYED</b><br/> <b>HIGHLANDS COMPUTER SYSTEMS</b><br/>         2 Cowell Street, Llanelli<br/>         Tel: 05542 70517<br/> <b>GLAMORGAN</b><br/> <b>BUCON LTD</b><br/>         18 Mansel Street, Swansea<br/>         Tel: 0792 467980<br/> <b>CARDIFF MICROCOMPUTERS</b><br/>         46 Charles Street, Cardiff<br/>         Tel: 0222 373072<br/> <b>GNOMON LTD</b><br/>         10 Mount Stuart Square, Cardiff<br/>         Tel: 0222 489484<br/> <b>PENNY COMPUTER SYSTEMS</b><br/>         Down Farm, Wick Road, Llantwit Major<br/>         Tel: 04465 4539<br/> <b>GWENT</b><br/> <b>GWENT COMPUTERS</b><br/>         151 Chapstow Road, Newport<br/>         Tel: 0633 215008<br/> <b>PRINTRONIC LTD</b><br/>         Hill House, Raglan<br/>         Tel: 0291 690214<br/> <b>SCOTLAND</b><br/> <b>GATE MICROSYSTEMS LTD</b><br/>         The Nethergate Centre, Dundee<br/>         Tel: 0382 28194<br/> <b>LOTHIAN</b><br/> <b>ANDREW WHYTE &amp; SON LTD</b><br/>         Hopetown Works, Hopetown Street<br/>         Edinburgh<br/>         Tel: 031 556 0191<br/> <b>SILICON CENTRE</b><br/>         7 Antigua Street, Edinburgh<br/>         Tel: 031 557 4546<br/> <b>STRATHCLYDE</b><br/> <b>COMMSMOTT LTD</b><br/>         30 Gordon Street, Glasgow<br/>         Tel: 041 226 4878<br/> <b>LORNE COMPUTER SERVICES LTD</b><br/>         12 High Street, Oban, Argyll<br/>         Tel: 0631 65635<br/> <b>VICTOR MORRIS (AU) LIMITED</b><br/>         340 Argyle Street, Glasgow<br/>         Tel: 041 221 8058<br/> <b>WEST COAST PERSONAL COMPUTERS</b><br/>         20 Wellington Square, Ayr<br/>         Tel: 0292 285082<br/> <b>NORTHERN IRELAND</b><br/> <b>CEM MICROCOMPUTER SERVICES</b><br/>         117 University Street, Belfast<br/>         Tel: 0232 244111/243564<br/> <b>EVERYMAN COMPUTER SERVICES</b><br/>         80 Charlotte Street, Ballymoney<br/>         County Antrim<br/>         Tel: 02656 62958<br/> <b>NEWBURN ELECTRONICS</b><br/>         58 Manor Road, Ballycarry, County Antrim<br/>         Tel: 09603 78330<br/> <b>SOUTHERN IRELAND</b><br/> <b>LENDAC DATA SYSTEMS</b><br/>         8 Dawson Street, Dublin 2<br/>         Tel: 710226/710796</p> |
|---|--|--|---|--|

CP/M is a registered trademark of Digital Research Inc. Econet is a registered trademark of Acorn Computers Ltd. Perfect Software is a registered trademark of Perfect Software Inc. Comanex is a registered trademark of Sapphire Systems.  
 Text, graphics and keyboard provided by BBC Model B.



**SPECIAL OFFER!**  
Deduct £1 per cassette or disc when ordering 2 or more.

**THE BEST BBC MICRO SOFTWARE**  
PRODUCED BY AN INDEPENDENT SOFTWARE HOUSE  
★ TOP QUALITY MACHINE-CODE PROGRAMS ★

**BBC**

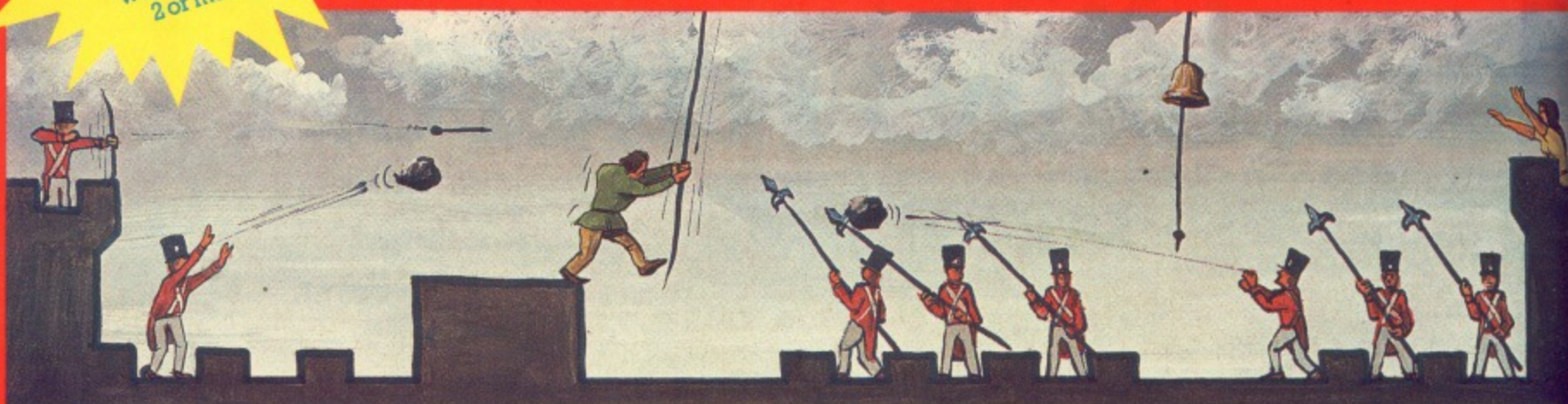

**HUNCHBACK (32K)** £7.95  
An excellent version of the arcade game where Quasimodo attempts to rescue Esmeralda. Beautifully detailed animation (the best we've yet seen!) as Quasimodo leaps over the ramparts dodging rocks and arrows, swinging on ropes, avoiding the guards' spears, and ringing the bells. Twelve different screens of action! This program is sold under licence from Century Electronics Ltd; we have exclusive rights to its sale for use on the BBC micro.  
(For use with **KEYBOARD** or **JOYSTICKS**).  
●●● NEW RELEASE ●●●



**CRAZY PAINTER (32K)** £7.95  
The only full-feature version available for the BBC micro. On the first screen, you take the part of a monkey being chased by African tribesmen. If you manage to survive by painting-in all the squares, the bonus screen features the monkey trying to reach his bunch of bananas. After that, you take control of a paint-roller and each square painted-in adds to your score. But beware... the teddy-bears are now in hot pursuit. Superb animation and sound-effects.  
(For use with **KEYBOARD** or **JOYSTICKS**).  
●●● NEW RELEASE ●●●

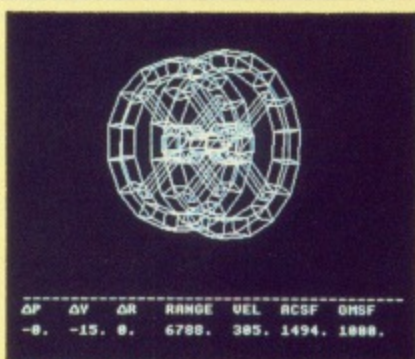

**2002 (32K)** £7.95  
A space docking simulator using a 3D graphics to model the motions and responses of the ORION 4 spacecraft. Your mission is to pilot the shuttle to a "soft dock" with the space station. **PITCH, YAW, ROLL, FORWARD, LATERAL** and **VERTICAL** engines are provided together with orbit manoeuvring booster engines. 6 skill levels provide for the completely inexperienced pilot as well as the fully-fledged commander.  
●●● NEW RELEASE ●●●



**ALIEN DROPOUT (32K)** £7.95  
A novel and unusual shooting game. Arcade-action with this exciting multi-stage shooting game. You have to shoot the aliens out of their "boxes" before the "boxes" fill up. Once full, the aliens fly down relentlessly, exploding as they hit the ground.  
(For use with **KEYBOARD** or **JOYSTICKS**).  
"... these moths are out to get more than the clothes in your wardrobe."  
... YOUR COMPUTER



**FAIRGROUND (32K)** £7.95  
An exciting target-shooting game! Bonuses are scored for spelling out the word **FAIRGROUND** by hitting the appropriate target letters, and for shooting all the targets. Extra bullets are obtained by shooting the numerical targets, but watch out for the "smileys" who are intent on stealing your bullets. Music, sound effects, hi-score, and rankings.  
●●● NEW RELEASE ●●●



**CENTIPEDE (32K)** £7.95  
Incredible arcade-style game featuring mushrooms, snails, flies, spiders, and the centipedes of course. Excellent graphics and sound. 6 skill levels, hi-score, rankings, bonuses, and increasing difficulty as the spiders become more lively and the number of mushrooms increases.  
(For use with **KEYBOARD** or **JOYSTICKS**).  
"Visually this game compares well with the arcade version, being colourful and clear."  
... YOUR COMPUTER



**ROAD RUNNER (32K)** £7.95  
The only full feature machine-code version available for the BBC micro. Features include: scrolling screen, radar display, 3 pursuing cars, checkpoint flags, fuel gauge, smoke screens, 6 skill levels, rankings, increasing difficulty, and sound effects.  
(For use with **KEYBOARD** or **JOYSTICKS**).  
"The game becomes very hard and has very smooth graphics. Excellent..." *BEEBUG MAGAZINE*.



**FROGGER (32K)** £7.95  
Not just another version of Frogger... this is the arcade-action version that you've been waiting to see. Graphically brilliant with gaping-mouthed crocodiles, diving turtles, flies, and frogs that flex their legs as they jump along. Increasing difficulty, and responsive controls.  
(For use with **KEYBOARD** or **JOYSTICKS**).  
"... very good indeed... fast flicker-free graphics and a frog that really hops!" *BEEBUG MAGAZINE*

**ALSO AVAILABLE**

- SPACE FIGHTER (32K) ..... £7.95
- GALAXIANS (32K) ..... £7.95
- INVADERS (32K) ..... £7.95
- FRUIT MACHINE (32K) ..... £7.95
- CRIBBAGE (32K) ..... £6.95
- PONTOON (32K) ..... £6.95

**DEALERS... DEALERS... DEALERS...**

Our software is now available at all good dealers including:-  
**W.H. SMITH** - Selected branches.  
**JOHN MENZIES** - Selected branches.  
**BOOTS** - Selected branches.  
**ELTEC COMPUTERS**, 29 Ivetgate, Bradford  
**MICRO MANAGEMENT**, 32 Princes Street, Ipswich  
**WEST COAST PERSONAL COMPUTERS**, 47 Kyle Street, Ayr.  
**MICROSTYLE**, 29 Belvedere, Lansdown Road, Bath.  
**ELECTRONEQUIP**, 36-38 West Street, Fareham, Hants.  
**3D COMPUTERS**, 230 Tolworth Rise South, Tolworth, Surrey.  
**GTM COMPUTERS**, 864 York Road, Leeds.  
+ MORE THAN 300 OTHER DEALERS THROUGHOUT THE U.K. AND OVERSEAS.

**ADVENTURE GAMES**

- COLDITZ ADVENTURE (32K)**  
..... £7.95
- STAR TREK ADVENTURE (32K)**  
..... £7.95
- LOST CITY (32K)** ..... £7.95
- GIDEON'S GAMBLE (32K)** . £7.95

**WE PAY 25% ROYALTIES FOR HIGH QUALITY BBC MICRO, ELECTRON AND ORIC-1 PROGRAMS**



**SUPERIOR SOFTWARE**

Dept. BMU 12,  
69 Leeds Road, Bramhope, Leeds  
Tel: 0532-842385

**DISC SOFTWARE AVAILABLE NOW**

All our programs are ready for despatch on 5 1/4" discs at £11.95 each.

**OUR GUARANTEE**

- (1) All our software runs correctly on all current operating systems and BASIC ROMs.
- (2) All our software is available before we advertise.
- (3) All our software is despatched within 48 hours by first-class post.
- (4) In the unlikely event that any of our software fails to load, return your cassette or disc to us and we will immediately send a replacement.



**ROBOTICS ARE  
ON THE MOVE**

THE manufacturers of the Zeaker, Colne Robotics, have had a boost to their expansion plans with a £200,000 capital investment from the Prudential. This is in addition to an earlier £150,000 injection.

The Zeaker, a low cost

robot for the BBC Micro, is aimed at the educational market.

New products from the firm will include a solid state computer vision system and a computer controlled lathe suitable for colleges of Further Education.

**Micro link  
on show**

PRACTICAL demonstrations of an inexpensive way to link up two BBC Micros will be one of the features of the BBC Micro User Show, to be held at the Westminster Exhibition Centre from December 8 to 11.

Experts on the *Micro User's* technical advice stand will be explaining the procedure, which was described in detail in the October issue.

The method outlined in the article has aroused a flood of interest and many users are now working on ways of incorporating it into games and other programs.

The show will include a number of specialist stands designed to give the BBC Micro user the most up-to-date information about his computer.

The government-backed Micro Electronics Project will be displaying all the latest in the world of educational computing.

The BBC themselves will be demonstrating their recently-launched telesoftware service, and our highly popular walk-in forums will include talks by some of the country's leading experts on the BBC Micro.

Scores of firms will be displaying their new products for the BBC Micro and Electron, many for the first time in public.

Latest to announce a

launch at the show is R.H. Electronics. They will be releasing a range of software and hardware products, including a video digitiser.



*The BBC Micro controlling a small lathe*

**Software floods  
in for Christmas****Accent is on education**

**CHRISTMAS** is coming, and so is a flood of new software for the BBC Micro.

Encouraged by the huge sales of BBC Micros to the schools, new software companies have been proliferating — mostly set up by publishing houses.

One of the most prestigious companies to enter the field is Cambridge University Press. They have joined ranks with Netherall School, the latest of our educational

institutions to succumb to the lure of the software market.

Not to be outdone, Longman, another of the establishment publishers, have joined with Loughborough Primary Micro Project to produce a range of educational titles aimed specifically at the home market.

Shiva Publishing has also chosen the Christmas season to launch a suite of four educational programs. Designed for five to eight-year-olds, the programs teach basic mathematical concepts.

Even the publishers of *Cosmopolitan*, the National Magazine Company, have entered the market. Their company,

Ebury Software, has launched a series of six titles aimed at the pre-school and infants market.

Reversing the trend somewhat, H & H, specialists in educational

software, has announced the launch of its first arcade game — *Looney Lift*.

Presumably, after all that worthy educational work, they were glad to let their hair down.

**Now — a 3D game**

WHAT is claimed to be the first truly three dimensional computer game has just been released by Postern.

“3-Deep Space” requires the use of special 3-D glasses which come with the package. When

wearing them the games graphics characters seem to pass in front of and behind each other, appearing to move in and out of the screen.

Postern claims that this opens up a new dimension in computer software.

**Choice is Xenix**

THE long awaited 32 bit second processor from Acorn will have Xenix as its operating system. Xenix is a version of Unix, an operating system that has gained wide acceptance in the world of mainframe and mini computers.

Logica UK will be adapting the system for Acorn.



# Radio boost for new technology

NEW YEAR will see BBC School Radio entering the field of the new technology with two series of educational broadcasts aiming to introduce youngsters to the basics of electronics.

This has been done in cooperation with the Microelectronics Education Program (MEP) and the Department of Industry.

Software to accompany one of the series is currently under development by King Alfred's College, Winchester, and the MEP.

It is intended that at least a part of this software will be available over the BBC's

Telesoftware service in the New Year.

This can then be downloaded via the BBC Micro's Teletext Adapter, saved, and used in lessons.

## Horizons

Speaking at a preview of the programmes, Claire Chovil, Head of School Broadcasting, Radio, said: "The age of technology opens up new horizons for our children. The education we give them must prepare them

for the opportunities which it will offer".

Despite this growing realisation that children have to experience the new technology in order to prepare them for the future, there is a shortage of suitably trained teachers.

## Expand

To aid this situation both series are designed for teachers with little or no electronics knowledge. The more experienced will be able to expand on the programs, including them in their own lessons.

The first series, "Junior Electronics", is aimed at introducing the 9 to 12 year old age group to the elementary concepts of electronics.

The second, "Micro-technology", is designed for 14 to 16 year olds and should be relevant to the current O-level syllabuses. A basic knowledge of electricity is assumed.

## Guiding

The emphasis is very much on learning by doing, the radio programmes guiding the children through practical experiments which can become the basis of a week's work.

The intention is that the programmes will be taped and used as needed in the classroom, each group of children learning at its own pace.

Both series have a special kit of components available for the children to use although the BBC are quick to point out that there is nothing to stop teachers making up their own packs.

For the micro-technology course there is also a breadboard and a bench power supply available.

There is a DoI subsidy on the first kit ordered for each school, showing the importance placed on this education for the electronic society of the nineties.

**Junior Electronics**  
Five weekly broadcasts. Tuesday 2.20-2.40 Radio 4 VHF. First broadcast February 28, 1984.  
Kit of parts and filmstrip available.

**Microtechnology**  
Ten weekly broadcasts. Friday 10.45-11.05 Radio 4 VHF. First broadcast January 20, 1984.  
Kit of parts, filmstrip, and breadboard available.

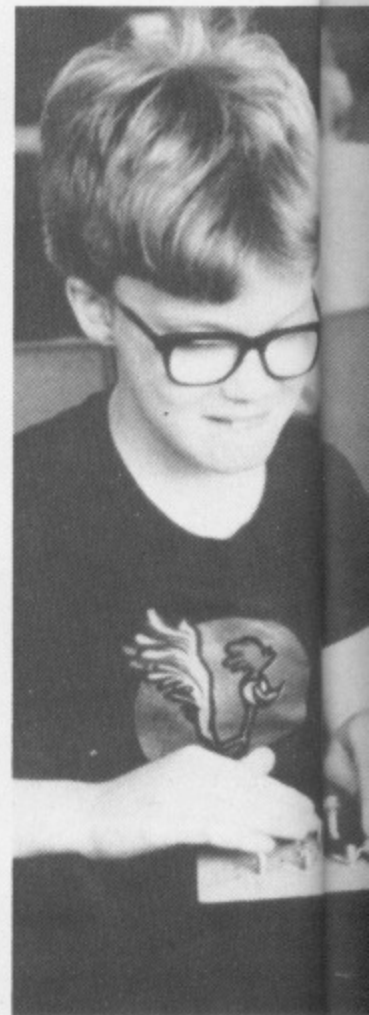

## Slimline disc drive is on way

FOLLOWING the successful sales of BBC Micros in High Street shops, Cumana, one of the UK's leading floppy disc drive distributors, has decided to enter the same market with a slimline disc drive.

The 5 1/4 inch disc drive comes complete with user manual, 2-drive connecting cable and a formatting disc.

Available in single sided 40 and 80 track, and double-sided 80 track formats, each drive comes

with mains power supply lead and plug.

This will be the first time that a computer peripheral has been sold in this way.

The emphasis is on providing both retailer and consumer with an attractive, easy-to-understand package. So the next time you buy *The Micro User* you might be able to get a disc drive off the same shelf.

## More titles adapted for BBC

THE ever-increasing sales of BBC Micros have caused major suppliers of software for other machines to adapt their programs for the BBC Micro.

Microdeal, one of the foremost software producers for the Dragon has converted its best-selling Shuttle program for the BBC Model B. Also released at the same time is their Air Traffic Controller.

Four titles for the BBC Micro aimed at the Christmas market have been launched by leading Spectrum software house, DK Tronics. Their Slicker

Puzzle, considered to be as compulsive and infuriating as the Rubik Cube, is tipped to be a best seller.

Also translated from the Spectrum is *The Hobbit*, Melbourne House's adventure based on Tolkien's novel, a copy of which is included with the game.

Extremely successful in its Spectrum version, the BBC Model B reincarnation has been eagerly awaited.

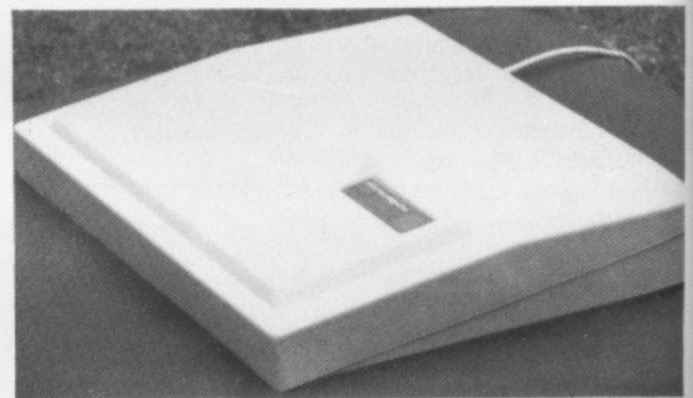

## Taking the brunt

A HARD cover to protect your BBC Micro from the deprivations of children, spouses and twentieth century life in general has just been released by Tekform Products.

Made in high impact ABS, the cover's cream textured finish matches that of the BBC Micro. With anti-slip foam pads on the underside to further protect the micro, the cover is expected to sell well to educational and domestic users.

## Micro plays lead

A BBC Micro is the star of a science fiction play being performed by pupils of Moorside High School, Manchester.

The play, "The Adventures of Harry Willetts, Cargo Pilot" is set on a spaceship in the near future. This has its own computer, Doris, played by one of the pupils sitting in a metal tank with only her head protruding.

Doris is considered one of the crew and can answer any questions put to her.

The BBC Micro works closely with Doris. It is

linked to a specially hired 45 inch TV and provides text and graphics displays to coincide with Doris' speech.

The idea of using the micro came from the play's producer, English teacher Alan Liptrot. He enlisted the aid of fifth year pupil David Pearson whom he describes as a "computer whizz-kid" to write the software.

"It started off as a small part of the production but now the BBC Micro has become the star", he said.





## Teachers launch software house

THREE North West teachers have turned their backs on classrooms to help more impact on the educational front.

They have pulled out of their schools in order to help launch a new software house - Optima - based in Stockport, Cheshire, which they are convinced will enable them to communicate far more effectively with schoolchildren than traditional teaching methods.

All three teachers - Peter Davidson, 32, Chris Price, 33 and Trevor Roberts 33 - are graduates and between them have teaching experience which ranges from primary schools through to sixth form colleges.

"We have not abandoned the kids but are simply adopting a new approach", said Peter Davidson, Optima's software development manager.

"What we are doing now will be far more meaningful than what we were able to achieve in the limitations of the class-

room system".

Optima Software's first wave of products include two programs tailor-made for schools across the country.

Datext, an easy to use teletext editing and library program, provides multi coloured worksheets suitable for anything from sixth form science experiments to nursery rhyme books for infants.

### Monitor

The newly-formed software company is also offering Optimon, a full machine code monitor which can be utilised as a learning tool for more advanced students.

It eliminates time consuming and unnecessary tasks and instructs the

youthful programmer on machine capabilities.

Although the main thrust of Optima's activities will be on the educational front, games will also figure prominently on its product list.

It has already received welcoming reviews for Asteroid Miner, Sea Wolf and Atomic Protector which it recently unveiled for the Christmas market. Other titles are scheduled to appear shortly.

"We aim to be a complete software house", says Peter Davidson. "But we obviously feel that we have that little something extra to offer in the educational field because of our teaching backgrounds".

## BRT picks BBC

BRT, the Belgian Dutch-language television service, is halfway to completing an educational series scheduled to begin in January.

There will be 12 half hour programmes, using the BBC computer, and these will be linked to a study course of textbooks and cassettes.

# Acorn sponsors world chess championship semi-finals

ACORN has pulled off Britain's largest chess sponsorship deal by sponsoring the semi-finals of the world chess championships to the tune of £100,000.

The deal, which allows the British Chess Federation to stage the matches in London, was made in the face of rival bids from Holland and Austria.

"It's all come as a bit of a rush", said a spokesman for the BCF.

"As yet we haven't arranged a venue for the games though they should start at the end of November and last for a month".

Acorn's sponsorship of the two matches is a coup for Britain after earlier arrangements had fallen through.

The game between the Russian Gary Kasparov and Russian defector

Victor Korchnoi was to have been held in California until Kasparov, complaining of security problems, refused to travel there.

Similarly, the game between the veteran Russian Smyslov and Ribli, the Hungarian, which was to have been held in Abu Dhabi, was cancelled because of the heat.

The offer from Acorn solves all these problems, allowing the series to go ahead.

## RECOMMENDED..

The two teach-yourself computing books recommended by the BBC in the weekly TV series "The Computer Programme" can now be obtained from *The Micro User*.

They are "The Computer Book", by Robin Bradbeer and "The Friendly Computer Book", by Jonathan Inglis.

They can be ordered using the coupon on Page 122.

## Keeping tabs on Ferraris

A BBC Micro along with a Z80 second processor (on field trials) is being used to keep records of buyers and sellers for a Ferrari brokerage.

The firm, Compute-a-Ferrari, was founded in January by David Hunt, younger brother of the former world champion driver.

Software for the system was made by Acorn who also sponsor David Hunt in Formula 3 motor racing.

Detailed descriptions of Ferraris for sale are

entered into the micro, covering 28 categories from the condition of the tyres and bodywork to interior marks - even cigarette burns.

Prospective buyers give details of the car they are looking for and the micro does the match-making.

The system has been so successful that there are plans to extend it to cover Porsche, Lotus and Aston Martin too.



## The BBC Micro stars in Belgium

THE popularity of the BBC computer is not limited to the United Kingdom.

The BBC users group in Brussels is already 135 members strong and growing daily.

The club meets once a fortnight, is extremely active, and has its own monthly newsletter.

The distributor for Belgium and Luxembourg, Société Luxembourgeoise d'Informatique, is providing strong support for the club.

### Expertise

A BBC Micro complete with discs and colour monitor has been placed on permanent loan with the group. A high level of expertise is available to beginners in both hardware and software.

One member is responsible for a 40/80 track disc switch which can be easily added to the BBC Micro and is featured in the new catalogue of Control Universal of Cambridge.

## Micros in the cottages..

BRITAIN will return to a society based on cottage industries, says Richard Fothergill, Director of the Microelectronics Education Programme.

This, he says, will be as a result of the new technology.

He cited BBC School Radio's microelectronic education series, which he

called "one of the more imaginative and innovative activities the MEP has been associated with", as an example of this tendency.

The series and their supporting hardware had been the result of co-operation between people and agencies spread across the country.

Two Newcastle housewives had designed the screen layout, while the MEP had provided the software.

### Components

A "garden shed"-based supplier in Liverpool was providing kits of components, with another small manufacturer in

Essex developing a power supply unit for the project.

This cooperation between small groups at a distance was, he felt, the blueprint of our future society. It would also become a major source of jobs for the young people who will make up that society.

## More hardware from Acorn

TWO new pieces of hardware have been unveiled by Acorn.

The first is the Acorn Bit Stik graphics system, a development of the well-known Apple Bit Stik. This is an extremely sophisticated computer aided design package consisting of the Bit Stik itself (a type of super joystick) together with dedicated software.

The system allows the user to define, with the minimum of keyboard input, a whole library of designs which may be then combined in a variety of methods.

Particularly interesting is the zoom feature, which allows you to magnify a fraction of the screen. You can add

details to that part of the design in high definition, then return to the standard magnification.

The system also permits images to be stored in a library and recalled at will. Said to be faster and to use less memory than the Apple version, the Acorn Bit Stik is one of the results of the company's new policy of buying-in products for the BBC Micro.

The second development promised is an IEEE interface for the BBC Micro.

This makes the machine the first com-

puter of its type to have available all of the standard I/O ports - RS423, Centronics and IEEE.

Aimed mainly at the laboratory market in schools and industry, Acorn claim that this is the first full specification IEEE interface available for a micro.

Also supplied with it will be an IEEE language system which can be used to control the attached equipment. Said to be simple to use, the IEEE language can be accessed from Basic and used by most schoolchildren.

## Light on data capture

A LIGHT pen claimed to be far easier to operate than others on the market has been launched by Datapen Microtechnology.

Said sales director Pam Rayner: "Most light pens on the market are difficult to use because the operator has little or no control over the pen's data capture as it approaches the screen."

"Our model has a LED readout showing that data is available. A switch built into the casing allows the operator to signal when the position is right".

The light pen, which comes with a range of software, retails at £25.

## BARRY WOOD'S TAILPIECE

THE other day I caught our beloved editor reading a copy of a rival magazine - you know, the one for squirrels.

He grinned at me sheepishly and said: "I can't resist the delicious feeling of deja-vu it gives me".

\*\*\*

I HAD a terrifying conversation with a software house this week. Their bright young chap said: "Our program's been tested on the 2.1 OS".

"Don't you mean 1.2", I glibly corrected him.

"Oh no", he replied, "our boss has got a

friend at Acorn, and the one he got from him is higher than that".

\*\*\*

WELL Mr Pike, we know your name, and we know you're a deputy headmaster.

What we don't know is your school, but we're quite confident that your pupils, who've been scrawling electronic graffiti over Prestel while you've popped out of the room, will inform us soon enough.

\*\*\*

LAMEST excuse of the year award must go to our associate editor who

was stopped by our gallant constabulary for speeding.

"Oh", said he, "I thought the 30 was in hexadecimal".

They let him off. Pity.

\*\*\*

IT'S lovely to see that the teletext adapter is such a nice creamy beige. It will go so well with my collection of second processors and Electrons.

\*\*\*

ACTUALLY we're all a bit miffed here because Acorn have poached our gorgeous marketing manager.

Come to think of it,

I've heard that Acorn are after me...

\*\*\*

"WHO told Barry Wood about our new DFS?" demanded a gentleman from Acorn of our less-than-gentlemanly editor.

"What new DFS is this?" enquired my unworthy superior. Exit Acorn man stage left.

So here's my project for this month. You've got to find the first Acorn spokesman to deny they're working on a new DFS.

\*\*\*

THOSE electronic vandals probably got the

idea from the hackers on Making the Most of the Micro Live.

I certainly can't see anyone getting anything else from it.

\*\*\*

SO, we're going to have Xenix for the 16032. I just can't wait to get it up and running on mine.

Question is, is it Xenix 0.1 or Xenix 1.2?

\*\*\*

SO Acorn are "computer modelling" race tracks so their car can go faster, are they?

Isn't it a pity that they haven't applied the same techniques to the Electron production lines?



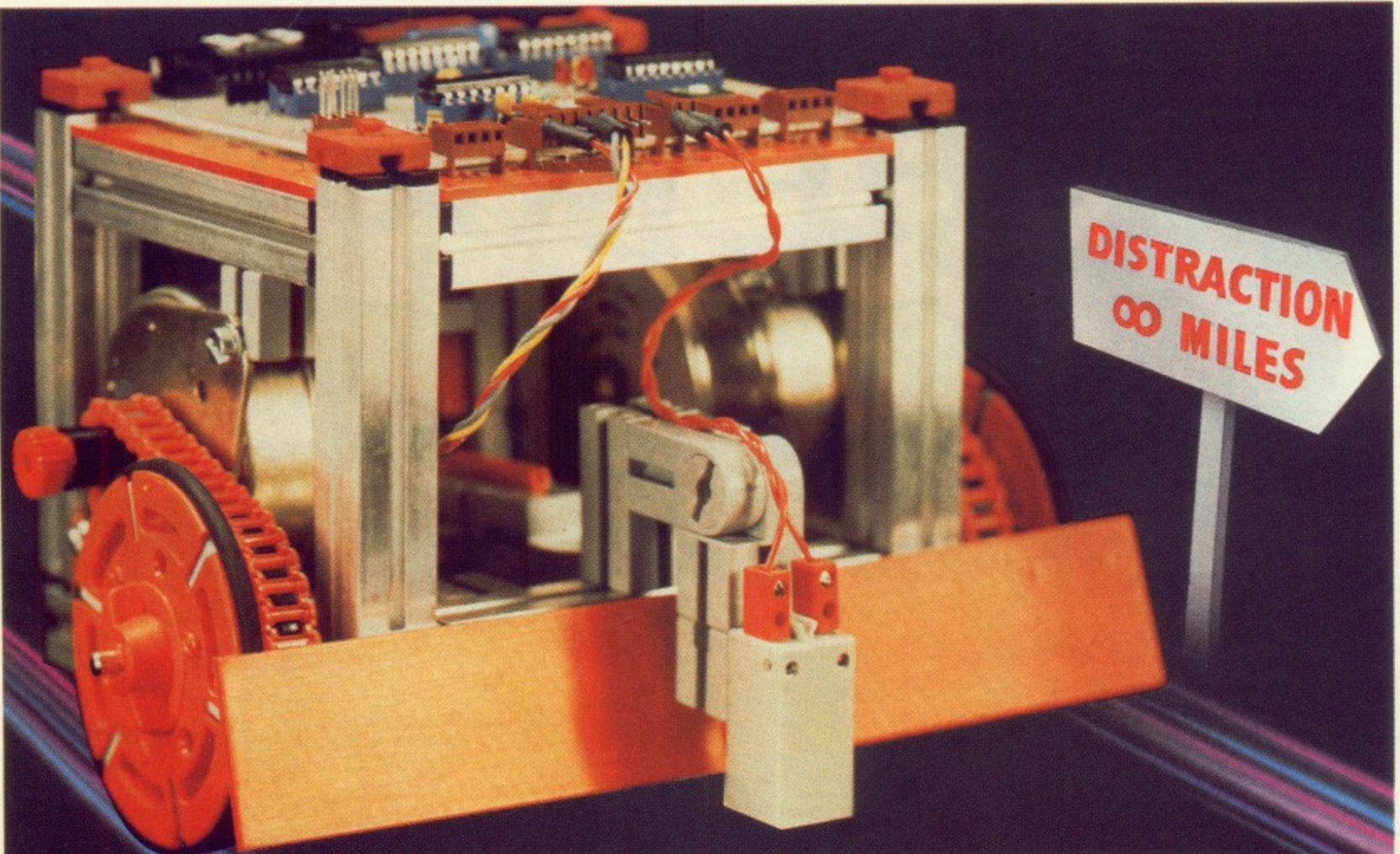

# DRIVE YOURSELF TO DISTRACTION

## WITH A **BBC** BUGGY

Trying to determine the limitations of the BBC Buggy is a task which will drive you to distraction. So sit back and accept the fact that your BBC Micro computer (Model B) controlled Robot will provide you with hours and hours of stimulating entertainment.

This rugged little vehicle which has been designed in conjunction with the BBC Computer Literary Programme and featured in the television series 'Making the most of the Micro' is built from an easy to assemble fischertechnik construction kit, complete with all necessary cables, software and instructions.



The Buggy's software which is based on the 'building block' principle consists of 12 robust application programs and one familiarisation program all of which feature full graphics.

Take a trip into the future without ever leaving your key-board – drive a BBC Buggy.

### PROGRAMS

- Test and familiarisation.
- Switch – direct computer control.
- Memory Switch – demonstrating computer memory.
- Routeplanner – advanced version of Snail.
- Recorder – route display.
- Snail – screen route planning.
- Explore for wall – mapping of boundaries.
- Explore for object – seeks objects, defines shapes, returns home.
- Bar Code Routeplanner – non-keyboard information input.
- Tin Pan Alley – composing music by bar codes.
- Man vs Buggy – 'Flying blind'.
- Sunseeker – seeking a light and negotiating obstructions.
- Line Follower – black or white line following.

The BBC Buggy is available from Acorn/BBC dealers and other major outlets.



## ECONOMATICS

Send me the  
BBC Buggy at

**£189.00**

inc. VAT, packing and postage

Name \_\_\_\_\_

Address \_\_\_\_\_

I enclose cheque/PO or debit my Access account (delete as necessary)

Card No. \_\_\_\_\_

Signature \_\_\_\_\_

Goods despatched within  
7 days of receipt of order

Economatics (Education) Ltd., 4 Orgreave Crescent, Dore House Ind. Estate, Handsworth, Sheffield S13 9NQ. Tel: (0742) 690801



Database Publications presents . . .

# THE BBC MICRO

## Westminster

(formerly the Royal Society)

### Greycoat Street, London SW1

The show that attracted record attendances in Manchester and Nottingham now comes to the heart of London - with a fabulous pre-Christmas bonanza of all that's best for the BBC Micro.

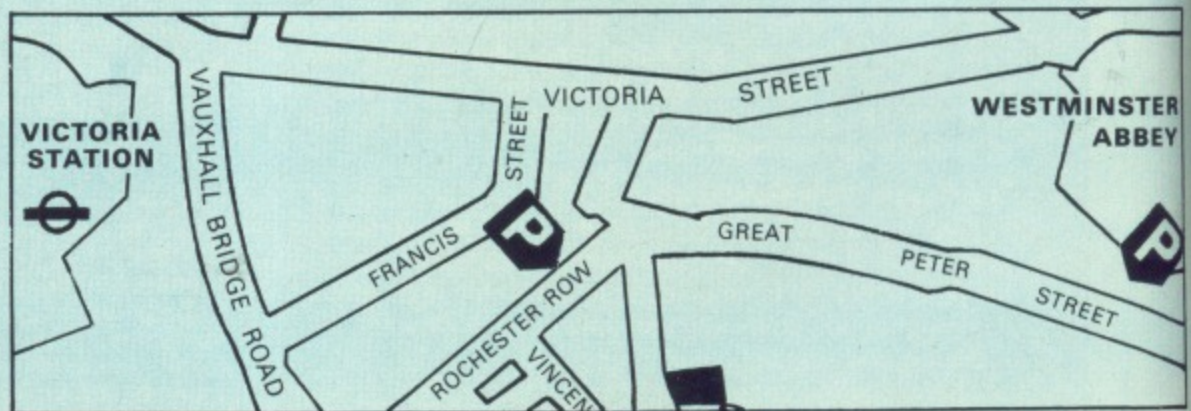

**Westminster  
Exhibition Centre**

**DON'T  
MISS  
IT!**

**Exhibitors include:**

Acom Computers, Akhter Instruments, Advanced Memory Systems, British Micro, Bradford Office Supplies, Bucon Ltd, Computersolve, CJE Microcomputers, C-Tech, C.W.P., Clwyd Technic, Clares Micro Supplies, Cumana, Commotion, Economatic, Educational Computing, Electronequip, Education Software, Glengary Soft, Golem, Kirklands Computers, Kansas City Systems, L.C.L. (Ludinski Computer-Assisted Learning), Lowland Designs, Logic Sales, MGB Software, Micro Aid, Micro Power, Microware, Microage, Master Class, Microvitec, M.W. Systems, Miniature Tool Company, Opus Supplies, Oakleaf Computers, Oak Software, Proteus Computing, Pace Software Supplies, R.H. Electronics, Superior Software, SYSTEM, Twillstar Computers, Viglen Computer Services, Watford Electronics.



# BBC MICRO & ELECTRON USER SHOW

## Exhibition Centre

(formerly the Royal Horticultural Halls)

### Thursday to Sunday, December 8 to 11

- ★ **ASK** the experts - free advice on all aspects of computing from people who know the BBC Micro inside out.
- ★ **CALL** in to one of our highly successful walk-in seminars, at which all the famous names from the world of BBC Micro computing will be taking part. Whatever your interest - graphics, machine code, interfacing, education - there will be a top expert speaking on it. (Saturday and Sunday only)
- ★ **TRY OUT** for yourself the games that will be the top sellers this Christmas - and well into next year.
- ★ **FIND** out about all the new peripherals for the BBC Micro - disc drives, interfaces, ROM boards, robots and second processors.
- ★ **DISCOVER** why the Electron - the baby brother of the BBC Micro - has been hitting the headlines and why all the experts are tipping it to be the big seller of 1984.

**£1**

off normal exhibition  
admission price of £3  
(adults) and £2 (children)

#### The BBC Micro User Show

10am - 6pm, Thursday, December 8  
10am - 6pm, Friday, December 9  
10am - 6pm, Saturday, December 10  
10am - 4pm, Sunday, December 11

Westminster Exhibition Centre,  
Greycoat Street, London SW1.

### GROUP BOOKINGS

Schools can obtain additional tickets by sending a stamped addressed envelope to: BBC Micro User Show, Europa House, 68 Chester Road, Hazel Grove, Stockport SK7 5NY.

**£1**

off normal exhibition  
admission price of £3  
(adults) and £2 (children)

#### The BBC Micro User Show

10am - 6pm, Thursday, December 8  
10am - 6pm, Friday, December 9  
10am - 6pm, Saturday, December 10  
10am - 4pm, Sunday, December 11

Westminster Exhibition Centre,  
Greycoat Street, London SW1.



# Drives of the future



Now available for the BBC Microcomputer, this superb range of high performance, low profile disc drives which give more data storage, and use less space.

The Pace range of drives include drives which are switchable between 40 and 80 tracks. As these drives are double sided they give a massive 400 k *per drive* in 80 track mode, whilst in 40 track mode they retain compatibility with Acornsoft and other

commercially available software. These drives feature colour LED's to indicate operation.

All Pace drives are capable of being used as double density drives so that, as and when, a double density filing system and interface become available, the disc storage capacity will be doubled (eg. the dual 40/80 drive will have an unbelievable 1.6m of storage).

Pace disc drives are designed to run off the BBC power supply and are supplied complete with all cables, a utilities disc and manual.

**PACE**  
Disc Systems

92 NEW CROSS STREET,  
Bradford BD5 8BS.  
Tel: (0274) 729306  
Telex: 51564 SHAREY-133



Dealer enquiries welcome

#### Disc drives available:-

##### SINGLE DRIVES

		ex VAT	inc VAT
PSD1	Single Sided 40 Track (100k)	£185	£212.75
PSD2	Double Sided 40 Track (200k)	£235	£270.25
PSD3	Double Sided 40/80 Track (400k)	£305	£350.75
PSD4	Double Sided 80 Track Only (400k)	£285	£327.75
PSD5	Single Sided 40/80 Track (200k)	£235	£270.25

##### DUAL DRIVES

PDD1	Single Sided 40 Track (200k)	£338	£388.70
PDD2	Double Sided 40 Track (400k)	£449	£516.35
PDD3	Double Sided 40/80 Track (800k)	£579	£665.85
PDD4	Double Sided 80 Track Only (800k)	£538	£618.70
PDD5	Single Sided 40/80 Track (400k)	£449	£516.35

Available from good computer stores everywhere including:

Computer City, Widnes, Cheshire. Tel: 051-420-3333. Computerama, Stafford. Tel: 0785-41899. Silcon Centre, Edinburgh. Tel: 031-557-4546.

Computerama, Stoke on Trent. Tel: 0782-268620. G.T.M., Leeds. Tel: 0532-647474. Wilding Computer Centre, Wigan. Tel: 0942-44382

National Micro Centre, Stockport. Tel: 061-483-3605. Sir Computers, Cardiff. Tel: 0222-21341. P.J. Microsystems, Crowthorne. Tel: 0344-772351.



SOME people find even Basic programs too fast, especially people learning to play a new game or possibly disabled folk. So here is a simple program to slow them down a little.

It will work with any Basic program provided that the variable U% is not used – this can be easily changed, see later – and it will work with some machine code programs (if zero page locations &70 to &90 are not used, and the interrupt is not disabled).

Load it before your usual program. Full instructions are on the screen.

All it does is put two nested loops (with nothing inside them) into the interrupt routine, so that the computer does a few loops every 100th of a second to slow it down.

In the program the registers are pushed onto the stack, X is decremented down from 40 (this can be changed in line 120), and Y is decremented from the value in U% (values from 2 to 5 work best).

The registers are then pulled back from the stack.

If U% is used in your program, change U% in lines 10 and 50 to some other single letter integer variable, and, in line 120, change &454 – the location where U% is stored – by 4 for each letter difference.

For example, to change to T% change the location to &450 ; V%=&458 ; W%=&45C ; and so on.

Avoid A%, P%, X%, Y%. If you want to avoid variables altogether, but make the speed more difficult to change, alter line 120 to, for example, 120 LDX#40:LDY#3.

Have fun experimenting! You can see how much the machine has slowed down by typing the following (or put it in a function key):

```
TIME=0:FORI=1 TO 1000: NEXT:
PRINT TIME
```

Note that as U% rises above 6 letters are missed if you do not depress them long enough as you type.

A value of U%=4 causes this simple test to take approximately twice as long as usual.

```
10 *KEY9U%=3
   :?&204=&70
   :?&205=0:K
20 CLS
   :PRINT "SPEED REDUCER"
30 PRINT "AFTER LOADING THIS PROGRA
   :M PRESS BREAK AND LOAD YOUR
   NORMAL PROGRAM IN THE USUAL
   WAY"
40 PRINT "BEFOPE RUNNING YOUR PROGR
   AM PRESS THE RED FUNCTION KEY
   9 (TO SET THE SLOW DOWNPROGRAM
   INTO ACTION); THEN RUN YOUR
   PROGRAM IN THE USUAL WAY"
50 PRINT "CHANGE SPEED AT ANY TIME
   (WHILE PROGRAM IS NOT RUNNING)
   BY TYPING "U%=(a number from
   1 to 5)" "AND RUNNING YOUR PROGR
   AM AGAIN"
60 PRINT "PROGRAM ASSEMBLED
   AT ";
70 PZ=&70
80 [
90 OPT0
100 SEI
110 PHA
   :TXA
   :PHA
   :TYA
   :PHA
   :CLC
120 LDX#40
   :LDY&454
130 .START DEX
140 BNE START
150 DEY
160 BNE START
170 PLA
   :TAY
   :PLA
   :TAX
   :PLA
180 JMP &DC93
190 ]
```

# HOW TO GIVE YOUR BEEB A DRAG FACTOR

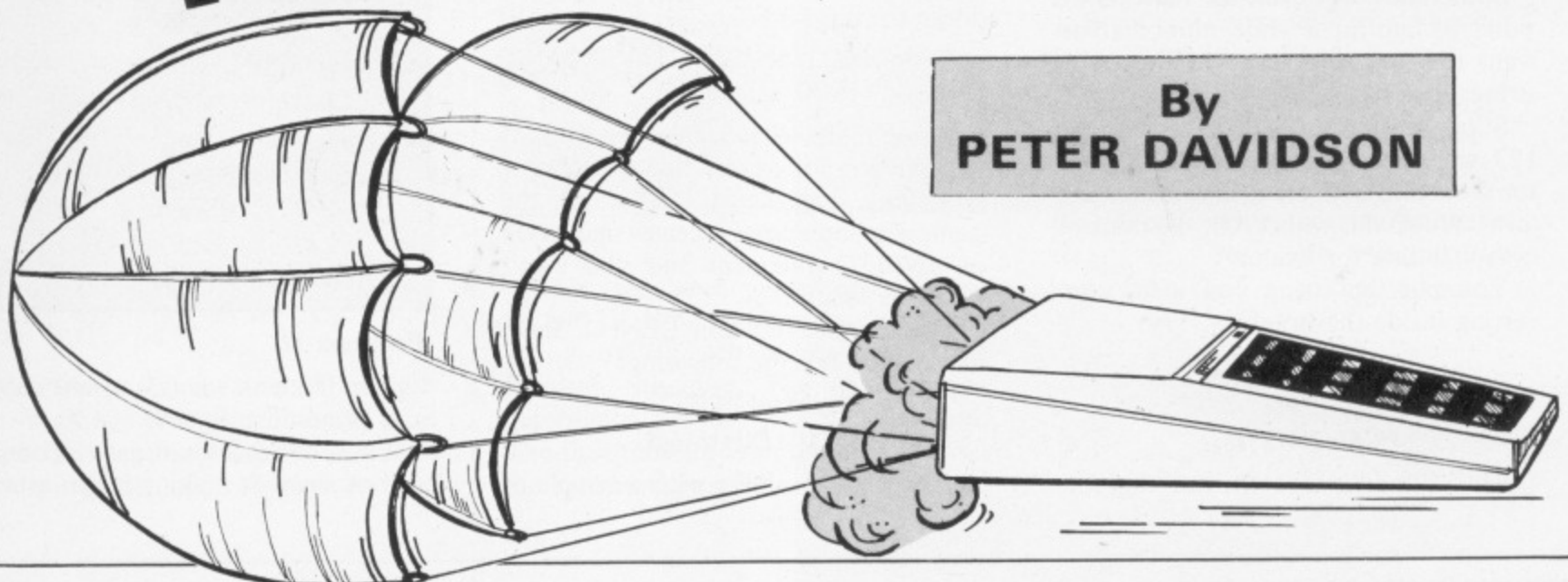

By  
**PETER DAVIDSON**



## Doing things with

LET'S start off this month by reviewing the difference between string and numeric variables.

String variables label "strings" of characters, such as "HELLO" and "GOODBYE".

Numeric variables label numbers in a way that lets us do sums with them.

We can use whole words for both types of labels.

You tell the computer it's dealing with a string variable by ending the label with a \$ symbol.

This means that *word\$* would label a string, while *number* labels a number.

We also met another type of numeric variable, the integer variable. In this case the label is followed by a % sign. Integer variables deal with whole, or integer numbers – they haven't learnt to do decimals!

Now the computer can remember a number in the form of a string variable, in the same way as it can remember any string of characters.

This means that:

```
number$="123"
```

makes sense. Enter it now. (Remember that when we assign a string variable, the string of characters must be in quotes.)

If you now try:

```
PRINT number$
```

you will indeed get 123 appearing on the screen.

So you can, if you wish, label numbers as strings.

You cannot, though, do sums with the strings. Try:

```
PRINT 2 * number$
```

and see what happens!

The moral is, if you want to do sums stick to numeric variables.

Sometimes, however, for reasons we won't go into for a while, numbers you want to work with may be stored in string form.

Suppose we want to do sums with the 123 we stored in *number\$*. We need some way to convert it into a numeric form. We do this with VAL( ) – think of it as standing for "value".

You put the string you want converting inside the brackets. Try:

```
number=VAL("123")
```

followed by:

```
PRINT 2 * number
```

This should prove to you that the

string really has been converted into a number! Notice that there are two variables here, *number* and *number\$*. The former is numeric, the latter string.

Of course, you can put the string variable inside the brackets rather than the full string. So you can use *number\$* rather than "123". Enter:

```
number=VAL(number$)
```

then:

```
PRINT 2 * number
```

and you'll see that it works just as well.

There's also a way to convert numeric variables into strings. Again you might be wondering why anyone would bother, but for the moment, just take it on trust that one day you'll want to! We use the function STR\$( ), which you can consider as standing for 'strings'. Enter:

```
number=123
```

followed by:

```
number$=STR$(number)
PRINT number$
```

and you'll see how it works.

Now when I said that you can't do sums with strings I was being completely truthful. However there is something you can do with strings that looks suspiciously like you're doing sums.

Enter:

```
string$="*"+ "@"
PRINT string$
```

What happens is that the '+' sign 'glues' the two strings together. The jargon calls this "concatenating strings". The add sign in this case doesn't mean addition. Try:

```
string$="123"+"123"
PRINT string$
```

and you'll see what I mean.

Sometimes it's useful for us to know how long a string is – after all, the computer sometimes receives strings via an INPUT statement and you won't know its length.

We use the function LEN( ), short for length. Try the following:

```
string$="ABCDEF"
PRINT LEN(string$)
```

Also try the above with a couple of

spaces between the first quotes and the A – spaces count!

Have a look at Program I.

```
10 REM *** PROGRAM I ***
20 MODE 6
30 first$="ABC"+" "+ "DEF"
40 second$="ABC"+" "+"DEF"
50 PRINT "first$ is "first$
60 PRINT "Its length is ";
LEN(first$)
70 PRINT "second$ is "second$
80 PRINT "Its length is ";
LEN(second$)
```

### Program I

Look carefully at lines 30 and 40. The strings *first\$* and *second\$* are not identical. In line 30 the second pair of quotes encloses a space. In line 40, the second pair of quotes enclose absolutely nothing – not even a space.

We say that they enclose the "null string" – that is, absolutely nothing.

This results in there being a space between the ABC and DEF in *first\$*, but there being absolutely nothing between the two sets of characters in *second\$*.

It also explains the different lengths.

Have a look at Program II. Notice, by the way, that lines 50 to 100 contain a lot of repetitions – judicious use of the copy key will save you a lot of typing!

```
10 REM *** PROGRAM II ***
20 MODE 6
30 string$="*"
40 PRINT "string$"
50 string$=string$+"*"
60 PRINT string$
70 string$=string$+"*"
80 PRINT string$
90 string$=string$+"*"
100 PRINT string$
```

### Program II

Line 30 sets *string\$* to one asterisk and prints it in line 40.

Line 50 then adds an asterisk onto the end of *string\$*, making it two asterisks



# with strings

long. It is then printed in line 60.

Line 70 similarly glues an asterisk on the end, line 80 then prints the whole string, and so on.

In describing the above program there was a "dead giveaway": I said that it contained "a lot of repetitions". If that's so, why didn't I use a loop? I rectify this in program III.

```
10 REM *** PROGRAM III ***
20 MODE 6
30 INPUT "How many times", number%
40 FOR loop%=1 TO number%
50 string$=string$+"*"
60 PRINT string$
70 NEXT loop%
```

### Program III

This is the first time we've actually INPUT the loop parameter, in this case *number%*. This means that we leave specifying how many times we perform the loop until the program is actually running!

Line 50 contains the heart of the program. Each time through the loop it increases *string\$* by one asterisk then prints it out. The result's a neat looking triangle of asterisks!

Try entering low values for *number%* at first. What happens if you enter 0?

Now that we understand the LEN( ) function, we can achieve the same results as Program III with a REPEAT... UNTIL loop. Look at Program IV.

```
10 REM ** PROGRAM IV ***
20 MODE 6
30 INPUT "How many
time$", number%
40 REPEAT
50 string$=string$+"*"
60 PRINT string$
70 UNTIL LEN(string$)=number%
```

### Program IV

Here we simply repeat until the length of *string\$* has reached *number%* (The length of *string\$* increases by one each time through the loop so we can use it to

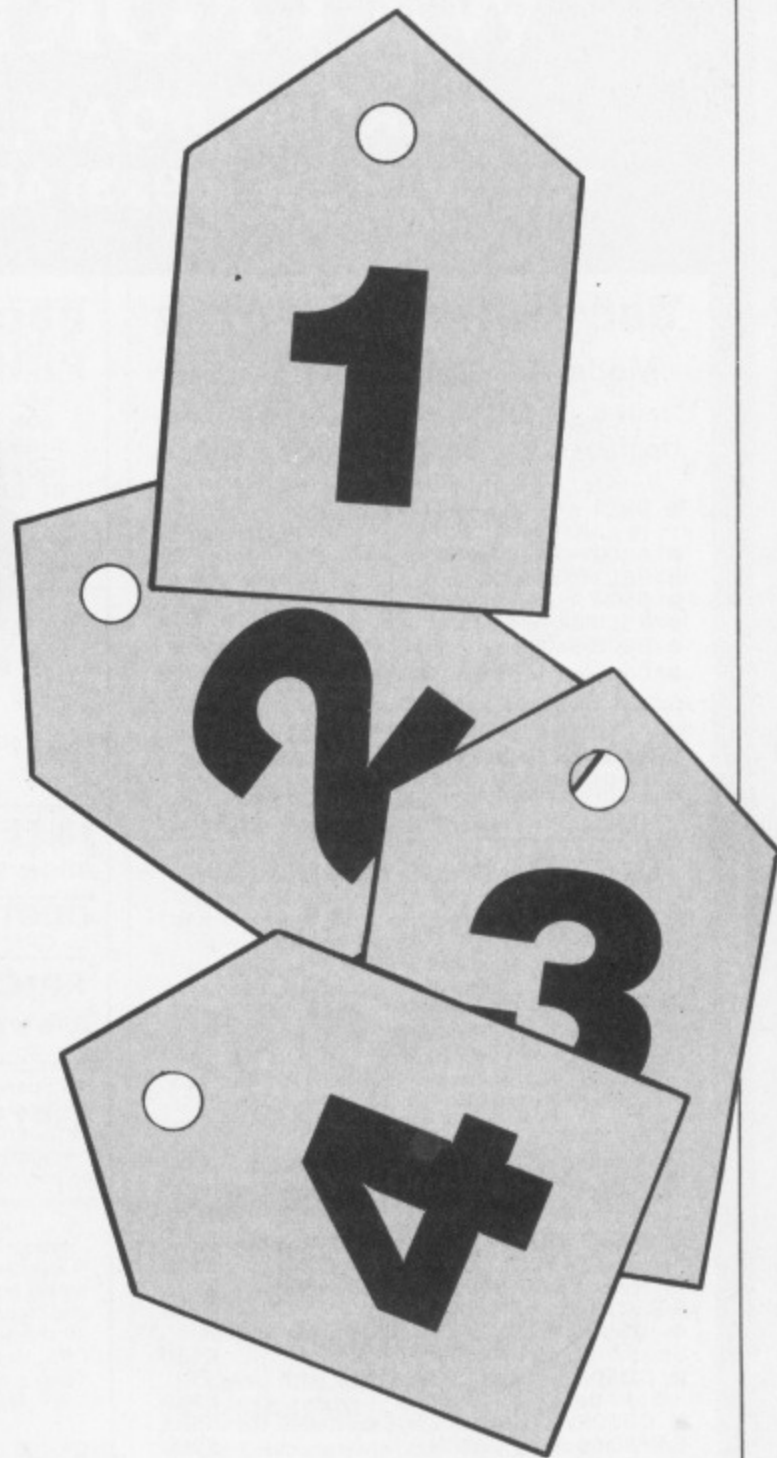

keep track of how many times we've "looped".)

Try Program V.

```
10 REM *** PROGRAM V ***
20 MODE 0
30 offset%=64
40 FOR loop%=1 TO 26
50 string$ = string$ + CHR$(offset%
+ loop%)
60 PRINT string$
70 NEXT loop%
```

### Program V

This uses the same idea as Programs III and IV. Line 50 simply increases the string by one character each time through the loop. The character is determined by the CHR\$( ) function. The first time through the loop it's 'A', the second time a 'B' is glued onto the

end of the 'A' and so on until we eventually have the whole alphabet.

Notice that line 20 puts the micro into Mode 0. This is so we can fit it all on the screen! You might want to return your micro to normal after the program with a MODE 6.

See if you can predict what happens if you changed line 50 to:

```
50 string$ = CHR$(offset% + loop%) +
string$
```

Finally, can you alter program V so that it still prints out its "alphabetic triangle", but with the alphabet reversed? That is, so that it goes:

```
Z
ZY
ZYX
ZYXW
....?
```



# WATFORD ELECTRONICS

CARDIFF ROAD, WATFORD, HERTS, ENGLAND.

Tel: Watford (0923) 40588/37774 Telex: 8956095 WAELEC

## BBC MICROCOMPUTER

Model A—£260; Model B—£346

Upgrade your Model A with our Upgrade Kits and save yourself £ s s

- BBC1 16K Memory (8 x 4816AP-3 100nS) £20.00
- BBC2 Printer User I/O Port £7.10
- BBC3 Disc Interface Kit £85.00
- BBC4 Analogue I/O Kit £7.25
- BBC5 Serial I/O Kit £7.50
- BBC6 Expansion Bus Kit £6.75
- Complete Mod. A to B Upgrade Kit £48.00

## Dust Cover for BBC Micro

Protects your expensive Micro from foreign bodies. £3.95

## DISC DRIVES (CUMANA)

### BBC COMPATIBLE

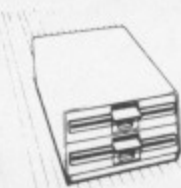

- **New TEAC Slimline Uncased Drive S/S** 40 track, 5 1/4", 100K £135
- **New TEAC Slimline Cased without PSU**, S/S, 40 track, 5 1/4", 100K £155
- **CS50A - TEAC Cased with own Power Supply**, S/S 40 track, 5 1/4", 100K £180
- **CD50A - TEAC Twin Cased with own PSU**, S/S, 40 track, 5 1/4", 200K £350
- **CS50E - TEAC Single Cased with own PSU**, S/S, 80 track, 5 1/4", 200K £250
- **CD50E - TEAC Twin Cased with own PSU**, S/S, 80 track, 5 1/4", 400K £475
- **CS50F - TEAC Single Cased with own PSU**, D/S, 80 track, 5 1/4", 400K £310
- **CD50F - TEAC Twin Cased with own PSU**, D/S, 80 track, 5 1/4", 800K £599
- **MITSUBISHI Slimline - Uncased**, double density. Double track, 5 1/4", 1 Megabyte, track density 96TPI, track to track access time 3mSec. Plugs directly to BBC Micro. ONLY £220
- **SINGLE MITSUBISHI Slimline - Cased with own PSU, DS/DD**, 1 Megabyte. (400K with BBC) £275
- **TWIN MITSUBISHI Slimline Cased with own PSU, DS/DD**, 2 Megabyte. (800K with BBC) £535
- Single Drive Cable for BBC Micro £7
- Twin Drive Cable for BBC Micro £10
- **Dual SWITCHABLE DRIVES**, 40/80, 400K. Cased with own PSU, Slimline £495

## 5 1/4" DISKETTES

5 year warranty

- 10 Verbatim or 3M Diskettes, 5 1/4", S/S £20
  - 10 Verbatim or 3M Diskettes, 5 1/4", D/S £30
- 2 year warranty
- 10 WABASH Diskettes, 5 1/4", S/S £15
  - 10 WABASH Diskettes, 5 1/4", D/S £25
  - Carriage on Drives £7

**DISC ALBUMS.** Attractively finished in beige leatherlook vinyl. Stores, protects and displays 20 Discs in double-sided clear view pockets.

Only: £4.95

## PLASTIC LIBRARY CASES

for Disc Storage 5 1/4" (holds 10) £2

## BBC GP100A PRINTER



10" Tractor Feed, 80 columns, 30CPS Normal & Double width Char. Dot res graphics. Parallel Interface standard. ONLY £170 (£7 carr.)

## INTERFACE CABLE

BBC to Seiksha Cable £10.00

## DUST COVER

for GP100 £3.95

## FRICTION FEED

Attachment for GP100A or 250X Printers £22

- Spare RIBBON for GP80 £4.50
- Spare RIBBON for GP100 £4.95
- Spare RIBBON for GP250 £5.95

## SEIKOSHA GP-700

A 7 colour graphic printer at the price of a standard dot matrix printer. Its unique 4 hammer method enables text and high res graphics to be drawn in 7 basic colours or 30 shades. 7 x 8 matrix. Up to 106 char. per line at 50 CPS. Variable line spacing to 1/120". Tractor or Friction feed. Centronix interface standard.

ONLY £375 (£7 carr.)

GP-700 Colour Printer Screen-dump routine in ROM FOR BBC Micro £12



Epson RX80

100 CPS, 9 x 9 matrix, dot addressable graphics, condensed and double width printing. Normal, Italic and Elite Characters. Tractor feed, 10" max width, bi-directional, logic seeking. Centronics Interface standard.

ONLY £255 (£7 carr.)

**RX80 F/T PRINTER:** As above but has both Friction and Tractor feed £284

## Epson FX80 Printer

160 CPS, 11 x 9 matrix, proportional spacing, superscripts, subscripts, dot addressable graphics. Normal, Italic and Elite characters. Up to 256 user definable characters. Down loadable character set. Condensed and double width printing. Full proportional spacing. Four user defined margin positions. Tractor and Friction feed. 10" maximum width Bi-directional, logic seeking Centronics interface standard.

ONLY £369 (£7 carr.)

## RX & FX INTERFACES

RS232	£38.00
RS232 plus 2K Buffer	£75.00
IEEE 488	£70.00
Parallel 2K	£62.00

	Ribbons	Dust Cover
MX80FT	£4.75	£4.50
MX100	£10.00	£5.25
FX80	£4.75	£4.95
RX80	£4.75	£4.50

## PRINTER INTERFACE BUFFER

When your system tries to serve you well but its efforts are frustrated by slow printers delaying from returning to more productive tasks then this is where our Printer Buffer Interface comes to your rescue. Available in 16K or 48K memory sizes. Simply connect the integral cables to your Micro and the Printer and switch on. The free standing compact unit (130x135x40mm) is supplied complete with interface cables, a power supply and a comprehensive manual.

Price: (16K) £120

## BROTHER 8300 DAISY WHEEL PRINTER/TYPEWRITER

Provides high quality type in six interchangeable styles. Ideal for business use. Friction feed; 11 cps; 12 inch max. width; 5 different colour ribbons; portable; hard top cover with carrying handle; connects directly to BBC Micro.

ONLY £395 (£7 carr.)

- \*\*\*\*\*
- ★ **SPECIAL XMAS OFFER** ★
- ★ Cumana CS50A Drive.....£180 £165
  - ★ Cumana CS50F Drive.....£310 £275
  - ★ Cumana CS50F Drive.....£599 £530
  - ★ Seiksha GP100A
  - ★ PRINTER.....£170 £155
  - ★ Seiksha GP250X
  - ★ PRINTER.....£225 £199
  - ★ Epson FX80 PRINTER.....£369 £349
- \*\*\*\*\*

## LISTING PAPER

- 8 1/2" x 9 1/2" Fanfold paper plain or ruled (1000 sheets) £7 (£1.50p carr.)
- 15" Fanfold paper (1000 sheets) £9 (£1.50p carr.)
- Teleprinter Roll (econo paper) £4 (£1.50p carr.)

## PRINTER LEAD 36"

Ready made printer lead to interface BBC Micro to EPSON, SEIKOSHA, NEC, etc., Printers.

ONLY £10

Special Extra long (60") Cable £14







# ★ THE ULTIMATE ★ BBC MICRO DFS

by Watford Electronics

Highly acclaimed at the Acorn User Show. What do the independent press say?

Good Value for Money—Beebug Aug. '83  
A very worthwhile package—The Micro User Sept. '83

Without a doubt, the most sophisticated DFS Software yet written for BBC Micro Computer. This powerful new DFS is fully compatible with ACORN DFS yet has much increased power due to additions, carefully designed to make life easier in normal use. It consists of over 14K of efficiently written machine code. It is entirely self contained and so does not require a utilities disc to function.

\* The system can either use the ACORN standard 31 files per disc side or DOUBLE THE CAPACITY to 62 files. The size is selected at formatting time. Copying between discs with different catalogue sizes works perfectly normally.

\* A FORMATTING PROGRAM is built in, permitting formatting to 35,40,80 track formats with either 31 or 62 files. Since the formatter is built in to the DFS it can be used without affecting whatever program you are using.

\* A DISC VARIFIER is also built in. This checks the internal checksums on each sector to identify any corrupted data. This is extremely useful when saving valuable data as it shows faulty discs quickly and easily. Again it does not affect the program you are using.

\* A built in DISC SECTOR EDITOR gives a screen window onto the disc enabling detailed editing of any byte on the disc. This is very useful for recovering accidentally deleted files and can save weeks of work.

\* A double step mode allows the user of 80 TRACK DRIVES TO READ 40 TRACK DISCS. This mode is software selected for each drive individually, thus allowing a 40 track disc to be copied onto an 80 track one very easily. THIS ELIMINATES THE NEED FOR EXPENSIVE SWITCHABLE DRIVES.

\* A WORKFILE function sets the name to be used when the null filename is issued. This allows a program to be edited and repeatedly saved having only typed its name once.

\* When using LOAD, CHAIN, etc. it is possible to specify an ambiguous filename. This will result in the first file whose name matches the specification being used. This saves typing the end of a filename that you know is uniquely identified by its first few characters.

\* Two commands exist to simplify the transfer of programs from TAPE TO DISC. These load the file to &1200, switch off the disc system and then move the file to its correct load address; thus saving a lot of complicated programming. This command can be used to load files up to 27K5 long.

\* An advanced COPY command is included which will prompt the user, requesting whether to copy each file.

\* RENAME has been extended to allow the use of ambiguous filenames. This allows you to change BERT1, BERT2, BERT3 to FRED1, FRED2, FRED3 with only one command.

\* OPENOUT has been improved to give you fewer annoying 'Can't extend' errors, as it automatically picks the biggest space on the disc in which to put a file. A SPACE command lets you know how much space \*COMPACT could create before you waste time doing it.

\* 1.75K of RAM can be taken over from the DFS for your large BASIC programs while still retaining LOAD, SAVE and \*CAT and other simple commands.

\* Comprehensive and clearly written Manual (available separately) gives the user a complete package deal.

\* Fully compatible with BBC TELETEX and TORCH Systems

DFS ROM only £39  
Complete Disc Interface including our highly sophisticated DFS ROM and fitting instructions £85  
Comprehensive and clearly written DFS MANUAL. (P.S. This manual will only be sold to those who purchase our DFS.) £7.50 (no VAT)

**P.S.**  
We will exchange your existing ACORN DFS or AMCOM (PACE) DFS for the highly superior Watford's DFS ROM for £35

ONLY THE BEST AT  
WATFORD

## BBC FORTH on Cassette

Follows FORTH-79 standard and has fig-Forth facilities  
—Runs faster than BBC BASIC.

ONLY £13

FREE 70 page manual and a Summary card.

## BBC FORTH TOOLKIT

Adds many more facilities to the above BBC FORTH.  
Supplied complete with 64 page manual. Only £9

**RESERVED**

This space is reserved for yet another of our ROM based software for BBC Micro. For details please read our advert in the next issue of this magazine.

## Computer Concept's Firmware

### BEEB-CALC £33

A ROM based spreadsheet program, like wordwise this firmware is fast and simple to use — yet is a powerful spreadsheet analysis program, considerably better than the original 'calc' program — full floating point maths. Works in 40 or 80 column screen modes — variable column widths. Works with either cassette or disc. This ROM coupled with Wordwise can turn your micro into an ideal small business machine.

### DISC DOCTOR £26

A sophisticated Disc Utility ROM with many useful commands. (For detail description please refer to Computer Concept's advert in this magazine.)

### TERMI £26

Computer Concept's Terminal Emulation ROM

## Wordwise

Without doubt a very sophisticated piece of software for the BBC Micro. It has all the features of a professional word processor yet is easy to use.

### SPECIAL XMAS OFFER: only £32

## DISASSEMBLER

Will generate fully labelled assembly listings of any machine code program. Data is automatically differentiated from code and displayed together with its ASCII equivalent. Assembly listing can be saved in \*EXEC format and subsequently incorporated into user programs.

Cassette: £6.95  
Disk: £8.95

## EMULATOR

An extremely powerful and flexible machine code interpreter. Allows you to write and debug machine code as easily as BASIC. Features single step, breakpoint register display, edit modes, etc.

Cassette: 7.25  
Disk: £9.25

## VIEW Acorn soft's Wordprocessor ROM. £52

ACCESS ORDERS BY TELEPHONE  
Simply phone your order through. We do the rest  
(0923) 50234

## FORTH ROM for BBC

This superb (FIG FORTH) compiling language now available in ROM. Simply plugs into one of the ROM Sockets. Manual included.

£36

## GEMINI'S BUSINESS SOFTWARE

Written by professional Chartered Accountants and coded by competent programmers. Ideal for small and medium sized companies. Now available from stock.

Cashbook Accounts	£52
Final Accounts	£52
Invoices & Statements	£17.25
Commercial Accounts	£17.25
Mailing List	£17.25
Database	£17.25
Stock Control	£17.25
Home Accounts	£17.25
Beebcalc Spreadsheet Analysis	£17.25
Beebplot	£17.25

N.B. All the above Gemini software is on tape. For Disc Based (40/80 track) please add £3.

## BOOKS (No VAT on Books)

30 Programs — BBC Micro	£4.95
30 Hour BASIC (BBC Micro)	£6.00
100 Programs for BBC Micro	£6.95
6502 Application Book	£10.25
6502 Assembly Lang. Programming	£12.50
6502 Assembly Lang. Subroutines	£11.80
6502 Software Design	£10.50
A young persons guide to BBC Basic	£4.50
ACORN ATOM Magic Book	£5.50
Advanced 6502 Interfacing	£10.95
Advanced 6502 Programming	£10.50
Assembly Lang. Programming for BBC	£8.95
Advanced Programming Techniques for the BBC Micro	£7.95
BBC Basic	£7.95
Assembly Lang. Prog. on BBC Micro	£7.40
BASIC Programming for BBC Micro	£5.95
BBC Forth	£7.50
BBC Lisp	£7.50
BBC Micro An Expert Guide	£7.50
BBC Micro Graphics and Sound	£6.95
BBC Micro ROM PAGING System Explained	£2.95
BBC Micro Revealed	£7.95
BBC Micro Instant Machine Code including Software Cassette	£34.00
Creative Adventure Programs on BBC Micro	£6.95
36 Challenging Games for the BBC Micro	£5.95
Creative Graphics Cassette (Acornsoft). Has 36 graphics programs	£8.95
Creative Graphics on BBC Micro	£7.50
Complete Programmer for BBC	£5.95
Discover BBC Machine Code	£6.95
Discover FORTH — Osborne	£11.25
Easy Prog. for BBC Micro	£6.50
35 Educational Programs for BBC Micro	£6.95
Further Prog. for BBC Micro	£6.90
FORTH Programming (Sams)	£12.50
Functional forth for the BBC Computer	£5.95
Games on your BBC Micro	£2.95
Games BBC Computer can Play	£6.95
Getting Acquainted/Acorn ATOM	£7.95
Graphs & Charts on BBC Micro	£7.50
Intro to Micro Beginners Book (3 Ed.)	£9.90
Introducing the BBC Micro	£5.95
Let your BBC teach you to program	£6.75
LISP	£9.25
Micros in the Classroom	£4.90
Practical Prog. for BBC & ATOM	£5.95
Programming the 6502	£10.75
Programming the BBC Micro	£6.95
PASCAL	£9.25
Logo Programming	£8.95
Mastering VISICALC (Sybex)	£11.95
Structured Prog. with BBC BASIC	£9.50
The BBC Micro Book, BASIC, SOUND & GRAPHICS	£7.40



## NEW DISC-FIX ROM

This ROM is an integrated, menu-driven DISC MAINTENANCE PACKAGE. Using simple menu selections, with intelligible prompts for any input required, the user can recover data from damaged discs. Facilities include:-

- Full screen editing of sectors on the disc.
- Sectors can be found by file name or sector number.
- Files and sectors can quickly and easily be dumped to a printer for examination and possible subsequent modification.
- COPY: blocks of data can be copied from any point on the disc to any other point. Blocks can be as small as one byte and can be transferred anywhere in a sector.
- SEARCH: The disc can be searched for any string, starting and finishing at any designated sector.
- VERIFY: Any block of sectors can be checked for their validity.
- FORMAT: Any track or group of tracks can be individually formatted to Acorn or Watford DFS standard.
- INSERT: Allows the manual creation of new directory entries to allow "undeletion" of files.
- BACKUP: This is similar to normal DFS backup but allows recovery after a disc error. Completely compatible with both Acorn and Watford Disc Filing Systems. Instruction manual supplied.

Price **£19.00**

## TINY PASCAL (in 16K ROM)

PASCAL-T is capable of compiling source PASCAL into a compact very fast threaded-interpreters-code. Full editor and disc support are included. Comprehensive documentation supplied

**£59**

## EDUCATION Software

### JUNIOR MATHS PACK (32K) **£6.95**

Makes learning fun for 5-11 year olds. This package consists of 3 programs (menu driven) that increase in difficulty as your child becomes competent. A very good supplement to standard educational methods.

### MATHS TRANSLATIONS **£5.50**

This package explains how to translate Triangles and Quadrilaterals, moving these geometrical shapes on a grid. It goes step by step through the concepts and the matrix calculations involved. Excellent software.

### WORLD GEOGRAPHY (32K) **£7.00**

Beautifully drawn Hi-Res colour map of the world illustrates and aids this graded series of tests on capital cities and populations of the world.

### WORDHANG **£7.80**

(Age 7-13). A word guessing program based on the well known Hangman game. Uses full colour graphics. Complete with 260 words and the facility save your own list of words.

### WORLDWISE **£7.80**

(Age 7-15). Two constructive geography programs allowing children to build detailed data bases covering both the UK and the world. Encourages children to refer to atlas and reference books. Save the database anytime.

### ANIMAL/VEGETABLE/MINERAL **£4.95**

(Age 7-13). Provides an opportunity for children to teach the computer to differentiate between objects. The program tries to guess the object the child has thought of, using personalised responses like Mmm ... I am thinking.

### BRITISH GEOGRAPHY **£6.95**

Teaches a child the locations of Cities and Ports using directional keys.

### CAROUSEL **£5.50**

Aimed at junior school age. Sequences of colours and sounds teaches a child to concentrate.

### HAPPY NUMBERS **£7.80**

(Age 4-6). No reading skills are required to use this colour graphics number recognition and counting program. Children build patterns of flowers corresponding to figures, quickly learning their significance.

### INTRO TO ARITHMETIC **£10.45**

4 programs - Additions, subtractions, multiplications and divisions. Help stage, moving graphics and colours. Worksheet produced at the end of program. (5-7 years old).

## BBC JOYSTICKS

Two versions available:

SINGLE: Player type **£7.00 each**  
TWO Players type **£11.50 per pair**

## NEW LAUNCH

### ★★★ PENGU ★★★

One of the most sophisticated full colour, 100% machine code games software. This arcade game will give hours of fun. You (Pengo) are being harassed by the devouring Snobees (Snow Beasties) whose diet is the Ice-cubes and an occasional juicy Pengo!! Your only means of survival is to hurl the ice-cubes at the marauding snobees and crush them into the snow. Beware, as you crush them to death the remaining snobees turn even more vicious. Each act will bring a new species, even more aggressive!!! All is not lost; Bonus points are won by lining up the three indestructible DIAMOND cubes. Progressive levels of difficulty. Bonus Pengo at 30K points. A MUST for all BBC Micro owners.

Only: **£7.75**

## VOLTMACE'S DELTA 14 Hand-set

(Highly acclaimed at the Acorn User Exhibition) Save your BBC Keyboard from a games bashing with our precision, smooth, sprung return 'Delta 14' Joysticks which has a built-in 14 Button Keypad. The hand set is Acorn Soft compatible and will work as a Joystick and two Fire buttons. Adding the ADAPTOR BOX will enable the use of all twelve Buttons (plus two repeated).

A user friendly, Keyboard to Keypad transfer program allows you to assign any Keyboard Key to either Keypad button or Joystick direction. The program also allows you to adjust sensitivity on the Joystick and conversions can be saved in a library which already contains some Acorn-Soft conversions.

Price: 'Delta 14' Hand set **£11.25**  
ADAPTOR MODULE **£11.95**  
TRANSFER PROGRAM **£5.15** (Tape)  
Disc **£7.75**

## PLINTH FOR BBC MICRO

Protect your micro from the weight of the heavy TV/Monitor. This sturdy plinth is attractively finished in BBC colour. It can be used to support a monitor or a printer. The micro slides underneath comfortably. A must for every BBC Micro owner, specially for those who have to move/open their computer frequently.

Price: **£10 (carr. £1.50)**

## PLINTH FOR PRINTERS

Keeps your desk tidy. Place the printer on the plinth and the paper underneath. Finished in BBC colour.

**£10 (carr. £1.50)**

## NEW NEW NEW

Yes it's here... the ROM you have been waiting for!!!

### BEEB PRINTER ROM

Are you fed up with not being able to unravel your printer manual and use all those features you paid for? Need sensible paging for use in the creation of booklets? Then you certainly need our Beeb Printer ROM.

A machine code printer utility in ROM.

\* 'Single' key operations replace control code sequences for underline, front and size selection, paper movement, etc. Up to 30 come pre-defined, without effecting normal fn key usage.

\* Automatic fanfold page margins. Puts gaps in listings. PRINTed text etc to skip the folds. The gap size alternates to minimise paper wastage when using binders.

\* Form feed and related commands, made available on ALL printers. Can also provide a left margin.

\* User defined characters embedded within text are printed as on VDU.

\* \* Commands select option for GP100, STAR, NEC, MX/FX, LP VII/DMP100, DMP200. Operates with parallel interface printers and is turned on by \*FX5.3.

Supplied complete with Manual.

Price: **£24**

(When ordering, please specify the make of printer you have.)

## ATTACHE CARRYING CASE for BBC Micro

These Attache Carrying cases are attractively finished in mottled antique brown leatherette. An ideal and very safe way to carry your BBC Microcomputer. **£12 (£2 carr.)**

## GAMES SOFTWARE (PROGRAM POWER)

ALIEN DESTROYER	<b>£6.95</b>
ANDEROID ATTACK (C.Concept)	<b>£6.95</b>
CHESS	<b>£6.95</b>
COWBOY SHOOTOUT	<b>£5.95</b>
CROACKER	<b>£6.95</b>
Escape from Moonbase ALPHA	<b>£6.95</b>
GALACTIC INTRUDER	<b>£6.95</b>
GALACTIC COMMANDER	<b>£6.95</b>
KILLER GORILLA	<b>£6.95</b>
LASER COMMAND	<b>£6.95</b>
MUNCHYMAN	<b>£5.95</b>
MASTERMIND	<b>£4.95</b>
MOONRAIDER	<b>£6.95</b>
MICRO BUDGET	<b>£7.95</b>
SWOOP	<b>£6.95</b>
SEEK	<b>£5.95</b>
747 FLIGHT SIMULATOR	<b>£7.75</b>

## LEVEL 9 ADVENTURE GAMES

COLOSSAL ADVENTURE. The classical mainframe game "Adventure" with all the original puzzles plus 70 extra rooms. **£8.65**

ADVENTURE QUEST. Through forest, mountains, desert, caves, water, fire, moorland and swamp on an epic quest vs tyranny. **£8.50**

SNOWBALL: Save a 7000 location colony starship in 2302 AD. **£8.50**

Prices correct at the time of going to press.

MAIL ORDER AND RETAIL SHOP. TRADE AND EXPORT INQUIRIES WELCOME. GOVERNMENT AND EDUCATIONAL ESTABLISHMENTS OFFICIAL ORDERS ACCEPTED. CARRIAGE: Unless stated otherwise, please add 60p to all cash orders.

VAT: UK customers please add 15% VAT to the total cost incl. Carriage.

SHOP HOURS: 9.00am to 6.00pm. Monday to Saturday. (Ample Free Car Parking Spaces)

ACCESS ORDERS: Simply phone: Watford (0923) 50234. (24 Hours)

# WATFORD ELECTRONICS

Dept. BBC, Cardiff Road, Watford, Herts, England.

Telephone: 0923 40588/37774. Telex: 8956095



# LONGMAN SOFTWARE

## -THE SOFTWARE USED IN SCHOOLS

Games  
for the BBC B



Developed by Loughborough Primary Micro Project

Longman's renowned BBC B Software for schools is now made available to the general public

Four specially produced versions for home computer users help children learn basic skills through games and colour graphics.

Each program on standard C10 cassette comes with complete instructions for use, as well as six pages of Parents' Notes.

£9.95 each incl VAT

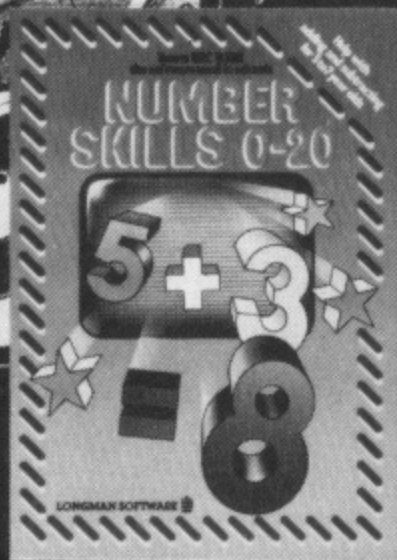
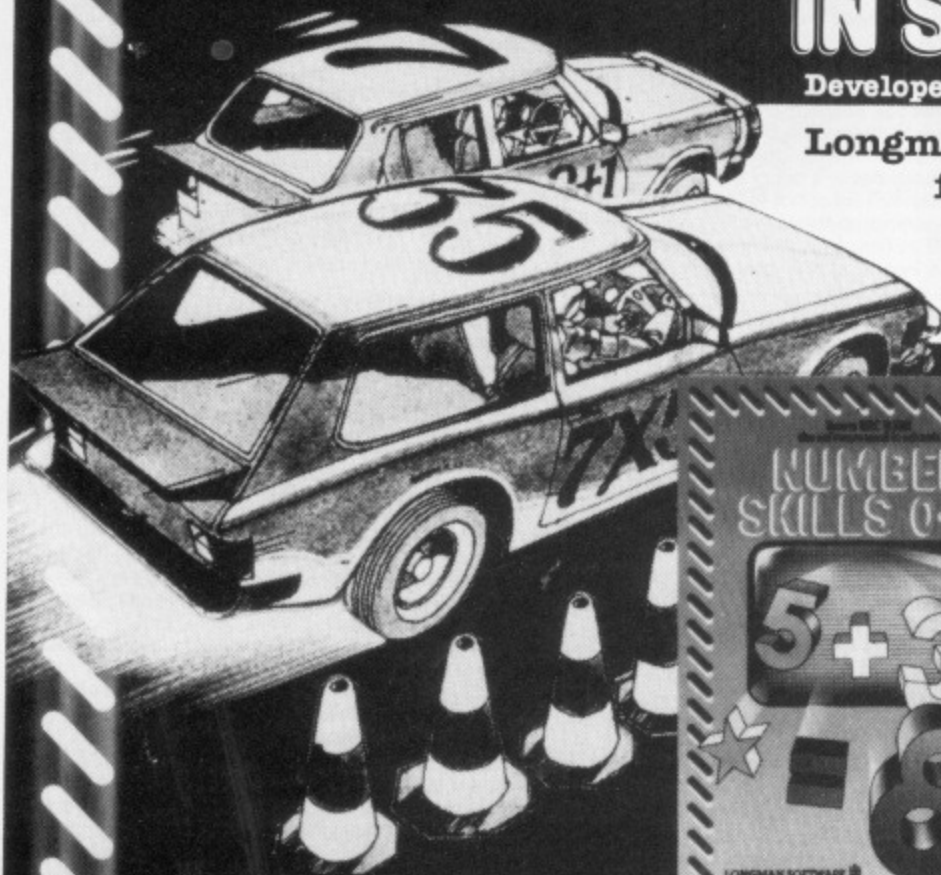

Gives practice for 5 to 7 year olds in adding and subtracting numbers between 0 and 20. If they need help children are shown the process involved in reaching the right answer.



Develops problem solving skills in 4 to 8 year olds. In helping the sheepdog drive the sheep into the pen, children learn direction skills and the 8 points of the compass.

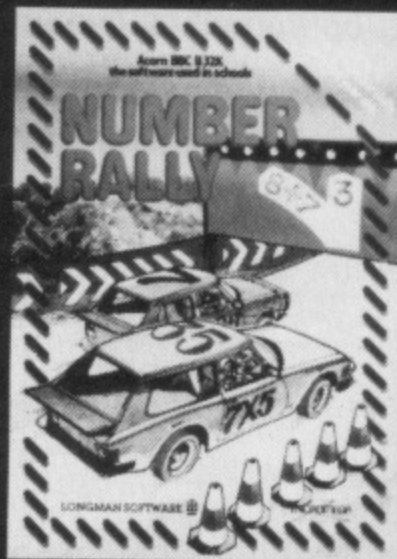

A game to practise numbers skills for 4 to 8 year olds. Adding, subtracting, multiplying and dividing - all fun to practice in this car rally game.



Practice in adding and subtracting one, two and three digit numbers to 999. If help is needed the correct answer is demonstrated on a grid using sound and animated graphics.

Available from W. H. Smith, Boots, Menzies, other leading chain stores and computer shops. Trade availability: Webster's Software Directory/Prism Microproducts/Lightning. In case of difficulty, or for a full colour catalogue, write to **Division GS14 (Software)** Longman Group Ltd Burnt Mill Harlow Essex CM20 2JE

LONGMAN SOFTWARE



ALEX BELL is the author of "Games Playing with Computers" and "The Machine Plays Chess?" Here he explains how you can test a chess program with some of the methods he has used over the last 20 years.

**DID you know that there are 14,772,512 ways of placing 16 queens on a 16 by 16 chess board so that no queen attacks any other? Or that you can mate a black king on an infinite board with a white king, rook, bishop and knight?**

Or that you can be a rotten chess player (like me) and still test and evaluate chess programs better than Bobby Fischer?

I was asked to comment on three BBC chess programs – *Acornsoft Chess* (£9.95), *BBC Soft White Knight* (£9.95) and *Computer Concepts Chess* (£8.95).

If you already have a chess program that allows you to set up positions then you can compare it with these (and other) programs using the following standard tests.

#### TEST 1: MATE TIMER

Ask the program to find two and three move mates from the opening position. The results were (in seconds):

	2 move	3 move
<i>BBC Soft</i>	<1	7
<i>Acornsoft</i>	9	257
<i>Concepts</i>	36	>600

BBC Soft was by far the fastest to report that there is no solution. Computer Concepts does not have a specific "mate in N" mode and has to be set to look at all moves at all levels down to three and five ply (a ply is a move by black or white). It chose P-K4 for a full three ply search and I got tired of waiting for the five ply response.

Acornsoft was intermediate but later testing showed that it does consider underpromotion which BBC Soft does not.

Testing the programs with genuine two move mate problems gave an average of about two seconds for BBC Soft, 50 seconds for Acornsoft and interminable for Concepts.

I was impressed by BBC Soft's speed and compared its performance using a problem that I have run on many other computers. The oldest machine was an ICL Atlas (circa 1963 and costing £3 million) with a program written in machine code which took four seconds – twice as long as a £10 program on a £400 micro. But the cycle times of the two machines are comparable – each could/can add about half a million numbers a second.

#### TEST 2: OPENING TRAPS

I always play black because there is

# Chess for three gives the White Knight a winning gambit

By ALEX BELL

more opportunity to lay traps and none of the programs have a book to protect them from errors. All tests gave the programs about one minute on average to play their moves. The first game was against the Acornsoft which, without any forcing, played:

1. P-K4 P-K4
2. N-KB3 N-QB3
3. B-B4

A Giuoco Piano and black has some nice traps, for example the Blackburne shilling game where you offer up a pawn with 3. N-Q5 – I have never seen a program refuse this one unless protected by a book so (See Photo II):

4. N×P Q-N4

Dumb programs play N×P forking the queen and rook but Q×NP threatens mate in one and white is in deep trouble. Acornsoft played:

5. B×P+ K-K2
6. B×N Q×NP
7. N-B6+ KP×N
8. R-B1 Q×KP+
9. Q-K2 Q×Q++

Move seven is the classic "horizon

effect" – anything to put off the evil check and checkmate. The best line at move six is to castle (and lose the knight – BQ×N) followed by P-KB4.

To test BBC Soft I forced the first three moves and it played:

4. N×P Q-N4

as expected. However one of the nice features of BBC Soft is that it displays the "Best line" – what it thinks is its best move and what the opponent will probably reply down to four or five ply. It clearly saw that Q×NP was going to be trouble but it played the same line as Acornsoft:

5. B×P+ K-K2
6. B×N Q×NP
7. P-Q3 K×R+

An unusual move to sacrifice the rook but it does give the black king a bolt hole.

8. K-Q2 Q×Q
9. K×Q R×B

and it's still playing, whereas Computer Concepts was just dumb:

5. N×BP Q×NP
6. R-B1 Q×KP+
7. B-K2 N-B3++

Another trap which can be tried from

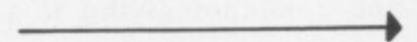



## From Page 39

white opening Giuoco Piano is the Wilkes-Barre line, thus:

1. P-K4 P-K4
2. N-KB3 N-QB3
3. B-B4 N-B3

which invites white to attack the weak KBP with N-N5. In fact, none of the programs would play this move (although it is all right if you know what you are doing) so I forced it on all of them. Concepts played:

4. N-N5 B-B4
5. NxBP BxP+
6. KxB NxP+
7. K-B3? Q-B3+
8. KxN P-Q4+
9. BxP Q-B5+
10. K-Q3 Q-Q5+
11. K-K2 B-N5+
12. K-K1 BxQ

BBC Soft also played 5. NxBP inevitable from move six when the king moved out towards the middle of the board.

White Knight also played 5. NxBP but the BxP+ made it think for over five minutes. It can do this because it only has to average one minute for each move (whereas Concepts sticks rigidly to its time for each move).

The "Best line" showed that it considered K-B1 for over half of the five minutes because the knight check is difficult to analyse. However greed overcame caution:

6. KxB NxP+
7. K-K3 Q-B3

This is better than Concepts but still greedy - if white retires the king it cannot have the black rook because of Q-B3, which either checks or threatens mate in one. But the best line is K-N1 because of the skewer or the following:

8. NxR Q-N4+
9. KxN P-Q4+
10. KxP N-N5+
11. K-B5 Q-K2+
12. K-N5 B-Q2+
13. K-R5 Q-B4++

Acornsoft was the only program to avoid the trap with the right move:

6. K-N1 Q-K2
7. NxR

and black has a poor game.

### TEST 3: END GAME PROBLEMS

Comparison of end game abilities is difficult because the time settings on the programs differ. Concepts always sticks rigidly to its one minute for each move whereas Acornsoft has playing levels which have to be set higher for an end game to play at the test speed.

BBC Soft only averages its moves to one a minute giving it a definite

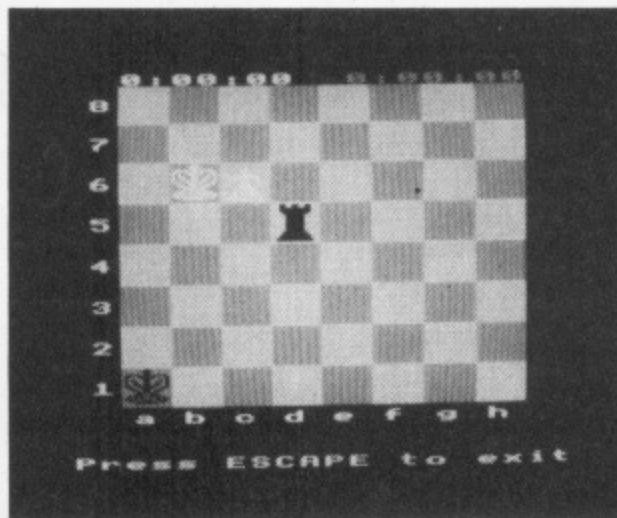

Photo I:  
Acornsoft Chess

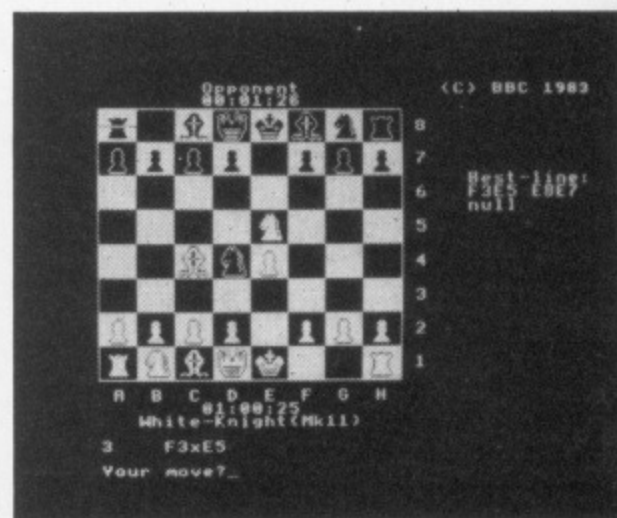

Photo II:  
BBC Soft White Knight

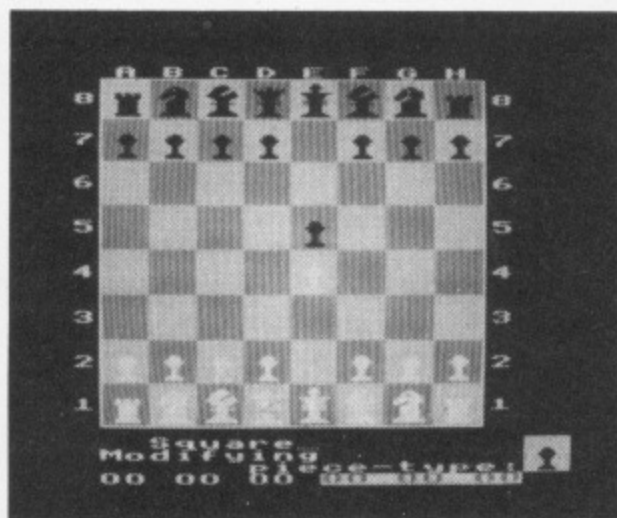

Photo III:  
Computer Concepts Chess

advantage in difficult positions.

All the programs appeared capable of performing the king, queen versus king ending (Acornsoft needs level six or seven for this and announces its move with a chime) but the king, rook versus king ending was too difficult for all of them.

They all tend to move the king to the centre of the board but then have no idea what to do with it.

An interesting question is how do these micro-programs compare with the tournament programs running on large mainframe computers?

Consider the position in Photo I, a

famous problem which has baffled many people since the turn of the century and a good test of a program's appreciation of repetition of position.

Mainframe programs circa 1975 were just reaching the point where they could solve such problems because they could be set to a "play and win" mode, appreciating that repetition is a draw and underpromoting the pawns.

This is the way it worked. The pawn is given a value equal to a queen - a fiddle but nevertheless equivalent to what a human expert does when asked to solve the problem.

The only move that can keep this



valuable pawn is P-B7 so the program should play it without any further investigation of the consequences.

To misquote Sherlock Holmes: "When all possibilities except one are eliminated then the exception must be the answer".

Black must now check the white king, and white, in order to avoid draw by repetition and avoid losing the pawn with a skewer, must move steadily down the knight file until it can play K-QB2 which prevents the skewer threat.

Black might then play R-Q5 which threatens stalemate (if white queens the pawn then R-QB5+) but tournament programs in 1975 could search 11-ply ahead and see that the underpromotion to a rook is a win for white.

None of the micro-programs (playing black or white) had any idea of how to play this ending although BBC Soft does have a crude appreciation of repetition of position and Acornsoft can underpromote.

I give this example in order to justify my opinion that these programs' playing abilities are roughly equivalent to the state of the art about 10 years ago on the most powerful and expensive computers.

They are incredibly cheap in comparison and the modern micro is about 10 per cent of the speed of the giants of 10 years ago.

But they are obviously still limited, mainly by their store size (hence the lack of book openings and knowledge of how to play end games).

The store size will increase on the BBC Micro when the Tube arrives. This means that the display handling (which occupies about 10k in BBC Soft - about one third of the machine) can be done by the second processor and the programs should then improve their openings and end games dramatically.

However, it is invidious to compare the modern micro with its giant ancestors on purely chess playing ability.

The micro, with its interactive features and display monitor, can and does support vastly superior display and manipulation features over the old programs.

Ease of setting up positions and selecting options are important factors in designing micro chess programs and the display of information is also very important.

For example, BBC Soft display of

the "Best line" is an inspiration by its author, 23-year-old Martin Bryant, and a feature that will become a must for future chess programs.

To actually see what the program is thinking about while you wait for its move is quite fascinating, particularly when testing it with traps.

Another nice feature of BBC Soft is the simple setting of its playing speed to an average time for each move. When in trouble the program reacts in an intelligent fashion by taking longer to make its reply.

### CONCLUSIONS

Concepts compared poorly with the other programs in almost every test and option. In terms of playing strength Acornsoft and BBC Soft are about equal, with Acornsoft rather easier to manipulate and with rather more options. It (and Concepts) allows you to save and reload a position with a filing system, an option BBC Soft's does not provide.

Nevertheless BBC Soft's "Best line" together with its very fast problem solving mode must give it the edge in terms of entertainment and value for money.

BBC Model B

**QUAL-SOFT**

present

£9.95

(inc. VAT and p.p.)

# "LEAGUE DIVISION ONE"

You are the manager of a football club that has just won promotion to the 1st Division. Your long-term aim is to build a squad of players who can challenge for the 1st Division Championship. But first you must use your present squad of experienced players, youth and your three close-season signings to survive. You must find the best blend quickly, covering for injuries and suspensions, whilst giving your young players 1st team experience to develop their abilities. The transfer market can supply the class players you're going to need, but only winning matches and improving gates will bring the money to buy such players.

In the short-term, you must get the points you can from the next match. It may be against Liverpool at Anfield, or the bottom of the league at home. It's up to you to decide the tactics and select the team for each match as it comes. Then you must sit on the bench and sweat it out with only a substitution available to change the balance of the game. Each game has a 3 minute graphics simulation which will tell you all you need to know about how your team is playing. Then it's on to the next match ... new tactics, new team maybe

Your contract is for five seasons, unless of course relegation ...

This game, at its simplest, will enthral a youngster providing he can follow a football league table, or at its most complex challenge a player fully trained in deductive logic.

**QUAL-SOFT**

Dept. CES  
18, Hazelmere Rd.,  
Stevenage,  
Herts.  
Tel: (0438) 721936

Please send me ..... copie(s) of  
LEAGUE DIVISION ONE.  
I enclose cheque/postal order to the  
value of £ ..... or debit  
my Access/American Express  
Card No. ....

NAME: .....  
ADDRESS: .....  
.....  
.....  
SIGNATURE .....



# New books and software are cropping up everywhere. Here's the pick of the bunch.



## USING BBC BASIC

by P.J. Cockerell

This book aims to develop both skills in BBC BASIC and a more intimate knowledge of some of the special features on the BBC Microcomputer. Programs and text are presented in an easy and accessible style. An introduction to some of the more esoteric aspects of computer science is provided which the reader is encouraged to investigate further.

December 1983 approx. 352 pages  
0471 90242 X approx. £6.95



## 6502 ASSEMBLY LANGUAGE PROGRAMMING

by J.N. Fernandez, D.N. Tabler, and R. Ashley

An introduction to Assembly Language programming for all 6502-based microcomputers. This book teaches the reader how to write programs in 6502 Assembly Language. It gives guided practice in coding hundreds of typical Assembly Language routines to those with no previous experience.

0471 86120 0 288 pages  
£9.75



## A YOUNG PERSON'S GUIDE TO BBC BASIC

by M. Milan

The book is a friendly programming primer which assumes no previous knowledge or experience of computing, emphasising the advantages of a structured approach to programming. Helpful hints for overcoming problems and making programming easier are given throughout the book.

0 85012 393 3 116 pages  
£4.50

Published by the National Computing Centre and marketed by John Wiley & Sons Ltd.

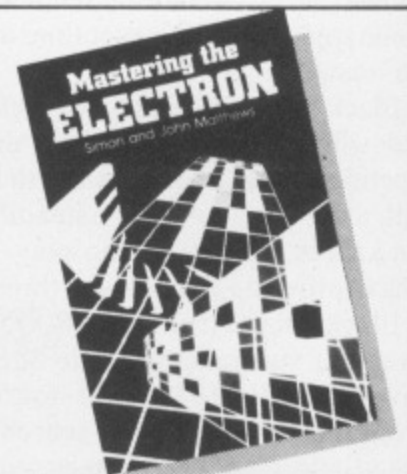

## MASTERING THE ELECTRON

by S. Matthews and J. Matthews

This new book will answer many essential questions for newcomers to the Electron microcomputer, showing them not only how to persuade the machine to do what it is asked, but how to do so in a sensible and readable way. All aspects of using the Electron are highlighted and covered in a clear, concise manner.

December 1983 approx. 280 pages  
085312 679 8 approx. £5.95

Published by Ellis Horwood Ltd. and marketed by John Wiley & Sons Ltd.

## COMPUTING FOR ALL THE FAMILY

With a BBC Computer

by Tony Noble

This book begins with an introduction to the uses of microcomputers then takes you through about 50 short simple, easy-to-follow steps that take you from turning on the computer to advanced BASIC programming. These have been thoroughly tested in schools with outstanding success — even with adults they have proved more effective, simpler, and more interesting than reading the manuals.

After this, there is a section of hints and tips for better programming and then listings and detailed explanations of highly motivating ADVENTURE-style educational programs specially designed for younger people.

Strongly recommended for parents wishing to reinforce the school computer experience in the more relaxed home environment.

December 1983 approx. 180 pages  
0905104 587 approx. £5.95

Published by Sigma Technical Press and marketed by John Wiley & Sons Ltd.



## TIME TRAVELLER

An Adventure in Time

by Sulis Software

Stranded 4000 years in the past, you have to survive the perils of the Bronze Age, Roman Britain and Norman, Renaissance and Victorian England in order to get back to the present. Wild animals, soldiers, priests, princes and germs are after you, and on top of all that, you've got to get your historical facts right before you can slip through the time warp into the next age.

0946658 331 Cassette  
£9.95

Published by Sulis Software Ltd. and marketed by John Wiley & Sons Ltd.

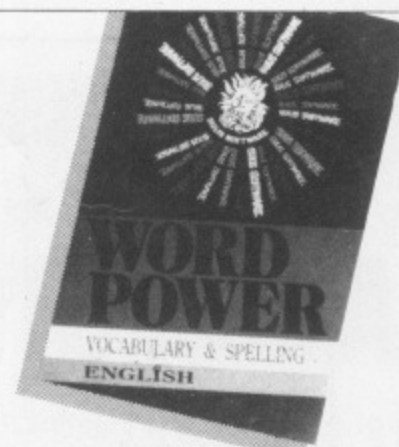

## WORDPOWER

Vocabulary and Spelling

by Sulis Software

WORDPOWER is a powerful package containing more than 1200 words, including opposites, synonyms, nouns/adjectives, collectives and similes. A choice of two games, plus a key-in option and different levels of difficulty make up a compulsive package — and you'll soon find you're packing a new punch with words you've never known how to use before.

0946658 021 Cassette  
£9.95

Published by Sulis Software Ltd. and marketed by John Wiley & Sons Ltd.

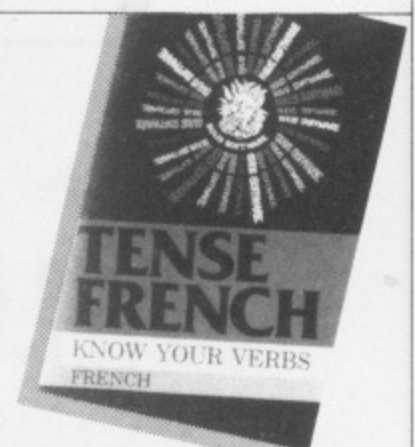

## TENSE FRENCH

Know Your Verbs

by Sulis Software

TENSE FRENCH teaches you how to get those basic French verbs right. The little beasts are translated, listed and tested, so that whether you've a gift for languages or not, they won't bother you again.

Working in the tense of your choice, you decide whether you want to be tested, when and what on.

0946658 552 Cassette  
£9.95

Published by Sulis Software Ltd. and marketed by John Wiley & Sons Ltd.



John Wiley are major publishers and distributors of books and software for the computing world. As well as Wiley professional reference books and software an extensive range of titles for the student and hobbyist is

available by other leading publishers including Ellis Horwood, NCC, Sigma Technical Press, Sinclair Browne and Sulis Software.

Ask for further details now at any good bookshop or computer store.

John Wiley & Sons Ltd · Baffins Lane · Chichester · Sussex PO19 1UD · England



# GRAPHICS

THIS MONTH we are going to use the graphic methods we've already discussed, plus some new ones, to produce a seasonal offering – a Christmas tree with an appropriate greeting.

The finished product is Program VII. Before that, though, we'd better look at a few of the techniques it uses, the most important of which concern user defined characters.

These characters, as their name implies, allow you to use the PRINT statement (or VDU) to print out your own special characters on the screen.

In the BBC Micro's graphics modes, all the characters are drawn on an 8 × 8 grid, each cell of the grid being known as a pixel.

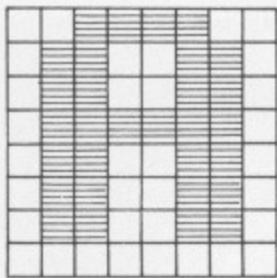

Figure I. Pixel pattern for the letter A

Figure I illustrates how the grid for the letter A is filled out. To print this letter by using its Ascii code simply enter:

```
PRINT CHR$(65)
```

Now the BBC Micro has several blank grids ready for you to fill. These grids have the Ascii codes 224 to 255.

Once you've filled, say, 224 with the required pattern of cells, to print out this user defined character, you type:

```
PRINT CHR$(224)
```

and it appears where the cursor is, with

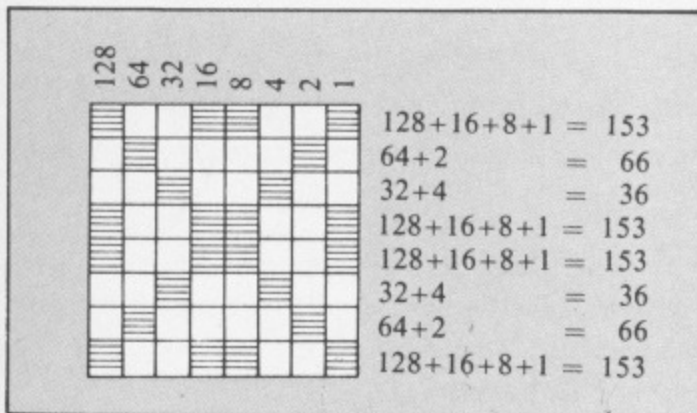

Figure II. User defined characters

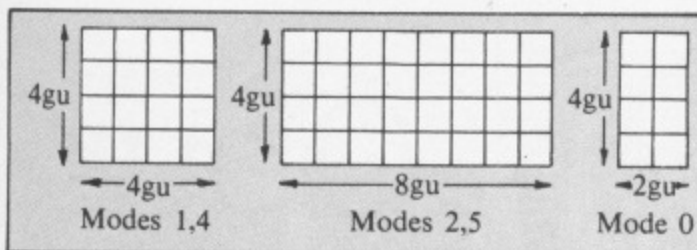

Figure III. Pixel sizes in each graphic mode

## Meet the pixels on your Christmas tree

By  
**MICHAEL NOELS**

the appropriate foreground and background colours.

Figure I illustrates how you can define your own character. You simply fill in the cells of the 8 × 8 grid until you get the pattern required. Then all that's needed is a few simple sums.

Each column of the grid has a value. The value of the rightmost column is 1, the one to its left 2, the one to the left of that 4, and so on, doubling each time until the leftmost column has a value of 128.

You may have noticed that these are the column values of a binary number.

Each row of the grid has a number calculated for it and you add together the column values of each cell shaded in that row.

Figure II shows the idea. Each row has its number. To teach the computer this pattern we use:

```
VDU 23
```

followed by the Ascii code we're going to use for it followed by the eight numbers we've calculated for the rows,

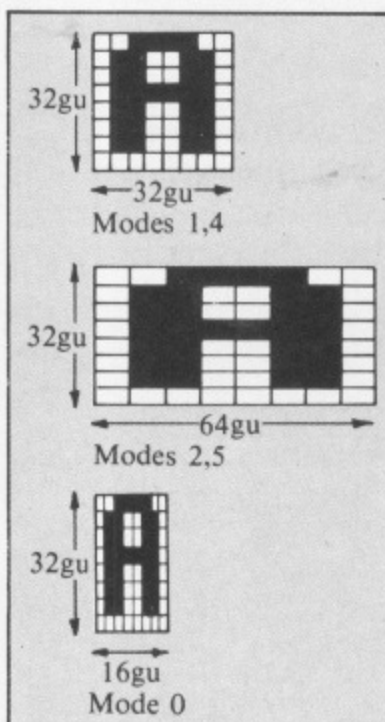

Figure IV. Character sizes in each graphic mode

```
10 REM *** PROGRAM I ***
20 MODE 4
30 VDU 23,224,153,66,36,153,153,36,
66,153
40 FOR I%=0 TO 19
50 PRINT TAB(I%,I%)CHR$(224)
60 NEXT I%
```

starting with the top and working down. All these are separated by commas.

So, to define character 224 to be the pattern shown in Figure II, we use:

```
VDU 23,224,153,66,36,153,153,36,66,153
```

Program I makes use of this character. Try altering line 20 to:

```
20 MODE 5
```

and notice the difference – the character is spread sideways. This is because the shape of the pixels in Mode 5 differs from that in Mode 4.

A pixel is the smallest point you can plot on a screen. Its size limits the resolution, or fineness, available.

As Figure III shows, in Modes 1 and 4, the pixel is four graphic units (gu) square, whereas in Modes 2, 5 and 0 it is variously oblong.

So when you print out an 8 × 8 pixel grid in Mode 4 it comes out square, whereas in Mode 5 the wider pixels stretch the figure. Figure IV shows the size of a character in each graphic mode in terms of graphical units.

You have to allow for this alteration in width when you are visualising your user defined character. I find it easier to see the character I want in terms of square pixels, so I've stuck to Mode 1 in Program VII even though it limits the range of available colours.

Let's try to print a pattern with our user defined character. We'll simply print the character three times, in a vertical line.

We can use the cursor control codes to ensure that the characters actually end up vertically aligned.

```
VDU 8 moves the cursor left
VDU 9 moves the cursor right
VDU 10 moves the cursor down
VDU 11 moves the cursor up
```



# YOU HAVEN'T SEEN ANYTHING LIKE THIS ON A COLOUR MONITOR BEFORE.

An RGB monitor from JVC offering a resolution of 370 x 470 pixels for less than £150?

We guarantee you won't see another bargain like that in this or any other micro mag—or in any other supplier's showroom.

For we've managed to acquire the sole distribution rights to these superb machines and we are able to offer them at an unbeatable price.

There are two models available: medium resolution (370 x 470 pixels) at £149.95; and high resolution (580 x 470 pixels) at £229.95. (Both excluding VAT.)

The units have a 14" screen and are suitable for the BBC Micro, Lynx, Oric, Apple, and most other leading micros.

They are robustly constructed in a handsome cream casing. And come with a full year's guarantee.

Delivery is good: your monitor should arrive by courier service within ten days of our receiving your order.

You can order by filling in the coupon below and posting to: Opus Supplies Ltd., 158 Camberwell Road, London SE5 0EE. Or by telephoning 01-701 8668 quoting your credit card number. Or, of course, you can buy in person at our showroom between 9am-6pm Monday-Friday, 9am-1.30pm Saturday.

MODEL REFERENCE	1302-1 Medium Resolution	1302-2 High Resolution
RESOLUTION	370 x 470 Pixels	580 x 470 Pixels
C.R.T.	14"	14"
SUPPLY	220/240v. 50/60Hz.	220/240v. 50/60Hz.
E.H.T.	Minimum 19.5kv Maximum 22.5kv	Minimum 19.5kv Maximum 22.5kv
VIDEO BAND WIDTH	6MHz.	10MHz.
DISPLAY	80 characters by 25 lines	80 characters by 25 lines
SLOT PITCH	0.63mm	0.41mm
INPUT: VIDEO	R.G.B. Analogue/ TTL Input	R.G.B. Analogue/ TTL Input
SYNC	Separate Sync on R.G.B. Positive or Negative	Separate Sync on R.G.B. Positive or Negative
EXTERNAL CONTROLS	On/off switch and brightness control	On/off switch and brightness control



To Opus Supplies Ltd., 158 Camberwell Road, London SE5 0EE.

Please send me \_\_\_\_\_ Medium Resolution Colour Monitor(s)  
at £149.95 each (ex. VAT).

\_\_\_\_\_ High Resolution Colour Monitor(s) at  
£229.95 each (ex. VAT).

\_\_\_\_\_ Connection lead(s) at £6.00 each.

I understand carriage per monitor will cost an extra £7.00.

(N.B. A Medium Resolution Monitor including VAT, lead, and carriage costs £187.39. A High Resolution Monitor including VAT, lead, and carriage costs £279.39.)

I enclose a cheque for £\_\_\_\_\_. Or please debit my credit card account with the amount of £\_\_\_\_\_. My Access/Barclaycard (please tick) no. is \_\_\_\_\_

Please state the make of your computer \_\_\_\_\_

Name \_\_\_\_\_

Address \_\_\_\_\_

Telephone: \_\_\_\_\_

**Opus.**  
Opus Supplies Ltd.

BU2



## From Page 43

Program II illustrates the technique.

Remember that we can string VDU statements together. Line 40 works like this: 224 prints the character, leaving the cursor directly to its right. 8 moves the cursor back left and 10 moves the cursor vertically down, leaving it directly under the first character. 224 prints the character again. 8 moves the cursor left and 10 moves the cursor down so that 224 prints the character vertically under the other two.

We can also use:

```
PRINT CHR$(8)
```

to move the cursor left, and so on for the other cursor movements. Although slightly longer, this has the advantage that we can add all the characters, user defined and cursor movement, into one string and then simply print out that string.

This results in the combined characters appearing far more quickly than with the VDU method. (See Program III.)

We use this technique in Program VII. Lines 210 to 290 each add together the user defined characters required to make the various shapes. Line 210, for example, defines a candle.

Notice how I use the name *candle\$* for the combined character string – it's

```
10 REM *** PROGRAM II ***
20 MODE 4
30 VDU 23,224,153,66,36,153,153,36,
66,153
40 VDU 224,8,10,224,8,10,224
```

```
10 REM *** PROGRAM III ***
20 MODE 4
30 VDU 23,224,153,66,36,153,153,36,
66,153
40 character$=CHR$(224)+CHR$(8)+CHR$
(10)+CHR$(224)+CHR$(8)+CHR$(10)+CHR$(
224)
50 PRINT character$
```

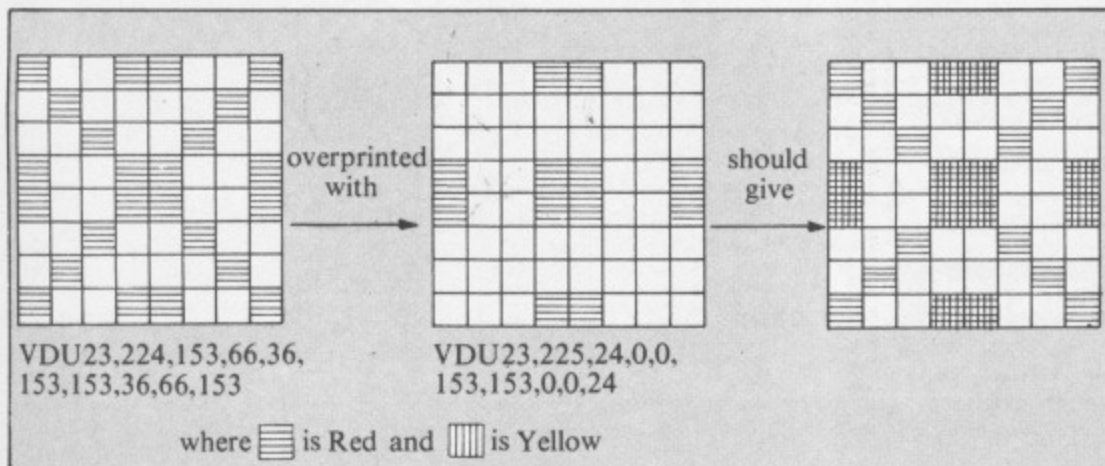

Figure V. Overprinting user defined characters

far more meaningful than, say, *shape1\$*.

In Program VII, the actual user defined characters are defined in lines 170 to 210, which read in the values for each VDU 23 from the DATA statements in lines 930 to 1060, 'VDUing' each parameter at a time (line 190).

Notice how -1 is used in line 1060's DATA statement to mark the end of the parameters.

When we print a user defined character, it prints, as we have seen, in the currently defined foreground and background colour.

Suppose, however, that we want a two-colour foreground, such that the centre pixels of our previous character and those in the middle of the outer edges are yellow, while the other pixels are red. (We'll leave the background black.)

You might think that we could do this by defining our character (224) as before and printing it in red, then overprinting it in yellow with another user defined character (225) containing only the pixels we want to be yellow. The red pixels should then show through.

Figure V illustrates the idea. However, it isn't as straightforward as this, as Program IV shows.

What happens is that the second character's background is printed, as well as its foreground, completely overwriting the first character!

We need some way of writing just the foreground of the characters – making the background transparent.

We can do this by using the command VDU 5. After such a command, the micro only prints the foreground of characters. This works not only for user defined characters, but for the whole character set as well.

There is one snag, though. VDU 5 also causes the characters to be printed not at the text cursor, but where the graphics cursor is.

Technically, we say that VDU 5 joins the text and graphics cursors. However, it's the graphics commands that are

```
10 REM *** PROGRAM IV ***
20 MODE 1
30 VDU 23,224,153,66,36,153,153,36,
66,153
40 VDU 23,225,24,0,0,153,153,0,0,24
50 COLOUR 1
60 PRINT TAB(19,15)CHR$(224)
70 COLOUR 2
80 PRINT TAB(19,15)CHR$(225)
```

```
10 REM *** PROGRAM V ***
20 MODE 1
30 VDU 5
40 VDU 23,224,153,66,36,153,153,36,
66,153
50 VDU 23,225,24,0,0,153,153,0,0,24
60 GCOL0,1
70 MOVE 640,512:PRINT CHR$(224)
80 GCOL0,2
90 MOVE 640,512:PRINT CHR$(225)
100 VDU 4
```

used to position the joined cursors – and to set colours – so I consider that VDU 5 causes characters to be printed at the graphics cursor.

This means that, after a VDU 5, to print a character at a certain location on the screen you have to place the graphics cursor there with the MOVE statement before PRINTING.

The numbers involved might take a bit more thought, but you gain two advantages. Firstly, you can position your character to the resolution of the screen, that is, within one pixel. With the TAB statement, you are limited to the eight pixel resolution of the character grid.

Secondly, of course, you only print the foreground of the character – there's no background to overwrite things.

Another useful aspect of operations after VDU 5 is that the cursor movement characters still work. For example, CHR\$(8) still moves the graphics/text cursor one whole character (eight pixels) left from its previous position. Try Program V.

Notice the use of VDU 4 at the end – this turns off the VDU 5. You should always tidy up this way – leaving VDU 5 in operation can cause problems. Try listing a long program with VDU 5 on to see what I mean.

Also, the relevant colours are the graphics colours, not the text colours, so we use GCOL0 instead of COLOUR.

A word of warning. Don't use TAB with VDU 5 on. Although you can get away with it in OS 0.1, your program won't work when you upgrade to later systems.

Now run Program VI. This has the



# GSL

A **GSL** COMPUTING PUBLICATION

# COMPUTING NEWS

DECEMBER 1983

ISSUE 2

## A NETWORKING MARRIAGE FOR THE BBC MICRO

### FROM GSL AND AMCOM



Rod Lewis (left), GSL's Sales Manager, discussing E-NET's speed, simplicity and versatility with a customer.

**E**-NET allows up to 200 computers to share a common, large central disc store, and overcomes many of the inconvenient features of earlier network systems.

E-NET uses a hard disc unit as the central disc store, allowing upwards of 8 Megabytes of storage. It has effective, simple structures to limit the disc space available to any user, and to permit access by any user to library programs. Many users of the few simple networks installed so far have complained of the difficulty of monitoring pupil's use of disc space, but E-NET overcomes all these problems by doing the monitoring for you. You simply allocate a space limit to each user on the Hard Disc using the

#### "GSL'S Impressive Customer Base"

- C.E.G.B.
- MANY UNIVERSITIES
- TROWBRIDGE CONSORTIUM SUPPLIES
- BBC PUBLICATIONS
- THE ROYAL NAVY
- BRITISH TELECOM
- HAMPSHIRE COUNTY COUNCIL
- PIRELLI
- NATIONAL COAL BOARD

### GSL Analogue Signal Display & Analysis System for the BBC/Acorn (Model B) Microcomputer

This systems enables a BBC Microcomputer (Model B) to function as a two channel, large screen, storage oscilloscope, for frequencies up to high audio values.

The basic system comprises an analogue to digital interface unit which is connected to the computer via the 1MHz bus. The accompanying software package enables input signals to be displayed in the time domain and also, if required, analysed via fourier transformation to give frequency domain representation.

The main features of the system are:

1. Two channel, large screen, display of signal amplitude vs time, with grid scaling information, channel identification and pk/pk measurement.
2. Repetitive or externally triggered sampling of input signals.
3. Display time (total sampling period) variable from 0.002 sec. to 25 secs.
4. Number of sample values = 100 per channel.
5. Minimum sampling time = 20 sec. (inclusive of both channels).

6. Software controlled triggering delay available.
  7. Option to list individual sample values.
  8. Either the following or preceding 'screen' of data is stored for each sampling period (the latter, only in triggered mode), and this may be displayed when required.
  9. Fourier analysis of the data for either channel may be performed, and the frequency domain representation plotted (50 values).
  10. Up to 5 frequency domain plots may be stored internally and recalled for comparison with the current plot.
  11. Full screens of information may be 'dumped' to a printer (NEC PC-8023B-C Dot Matrix Printer), for both the amplitude vs time and amplitude vs frequency displays.
- The programme is loaded from tape using the command CHAIN "scope".
- Price £350.00 Excluding carriage + VAT.

AMCOM'S E-NET is a flexible network filing system for the BBC microcomputer, specially designed in conjunction with GSL for Education use. It uses the network interface in the BBC machine so that if you already have networked machines it only requires fitting a new ROM in each clients machine and installing the Hard Disc Unit. (If you do not have network B's then a network interface has to be fitted to each machine).

simple command program. For most schools and colleges this size disc will allow each user to have a reasonable file store, but it can be extended if required by adding further hard disc units. Important files can be easily copied to minifloppies if required.

E-NET has many useful extra commands. For example a simple command which only operates from the master (teacher's) machine, and which forces each client machine (in a certain specified room or area) to load and run

a particular program is included. This is very fast, and flexible, and allows for efficient use of C.A.L. packages. Care has been taken to ensure that the command structure is simple enough not to intimidate the non-specialist, while remaining flexible and robust.

E-NET allows one or more printers to be connected to the network and although this is connected to one of the network computers this computer can still be used even while the printer is in use.

	Price £
5 MB Winchester System	1650.00
10 MB Winchester System	1950.00
20 MB Winchester System	2400.00
65 MB Winchester System	4700.00
105 MB Winchester System	5130.00
140 MB Winchester System	7000.00
280 MB Winchester System	9500.00

E-NET is fast, simple to use and versatile. The first system being installed for use in September, and demonstrations can be arranged.

#### Large stock of Computer Peripherals always available

GSL know from talking to their customers that nothing is more frustrating than responding to an advertisement and finding the advertised goods are out of stock or not readily available. GSL hold large stocks of all computer peripherals advertised.

- The GSL range is constantly growing and currently included:
- BBC MICROCOMPUTER
  - SHUGART DISK DRIVE RANGE
  - NEC PRINTERS
  - EPSON PRINTERS
  - PRINTER BUFFER
  - MICROVITEC COLOUR MONITORS
  - SANYO COLOUR MONITORS
  - KAGA GREEN SCREEN MONITORS
  - TORCH Z80
  - VARIOUS SOFTWARE INCL. WORDWISE
  - PRINTER PAPER

### EDUCATION APPROVED DISK DRIVES MATCHING ACORN BBC MICRO

All disc drives supplied in metal case finished to match the Acorn BBC microcomputer.

Shugart SA200 Capacity 100K — Price £144.50 including Leads.

Less than two-thirds the height of standard models, Shugart's single-sided SA200 5-25 inch minifloppy disk drive offers 125 or 250 Kbytes of capacity in a low cost highly reliable package. Low cost, compact size and high reliability make the SA200 an ideal choice for entry level desk top applications in personal computers, word processors, memory typewriters, portable computers or terminal add ons. Package includes all interconnecting leads.

Shugart SA455 Capacity 200K — Price £238.00 including Leads.

Shugart SA465 Capacity 400K — Price £281.50 including Leads. Prices excluding carriage and VAT.



The complete system is compact and easy to use.

Shugarts SA455/465 half height mini floppy disk drive offer a compact alternative to standard height drives for desk top systems requiring maximum performance in a greatly reduced space. Since users can quickly double existing storage capacity by fitting two drives in the space formerly occupied by one standard minifloppy the SA455/465 drives provided and excellent means to increase storage capacity without increasing space.

**Return to GSL COMPUTING LTD,** 2 North Way, Andover, Hampshire SP10 5AZ  
I am interested in the following:

(please tick)

The GSL Winchester System

5 MB

10 MB

20 up to 200 MB

The GSL Slim Line Disk Drives

Your full range of Micro Computers and computer peripherals

GSL Analogue Signal Display and Analysis System

GSL Printer Buffer

Name: \_\_\_\_\_

Position: \_\_\_\_\_

Company: \_\_\_\_\_

Address: \_\_\_\_\_

Phone: \_\_\_\_\_

Send me by return full technical information

or phone Rod Lewis on Andover (0264) 58744/51699

M.U.

**We are an official Acorn Dealer and Service Centre**  
Dealer Enquiries Welcome



**From Page 45**

same effect as Program V. In this case we define a string to print out our multi coloured character (line 50). The latter might need some explanation.

Instead of using GCOL0, 1 we can:

```
PRINT CHR$(18) + CHR$(0) + CHR$(1)
```

where CHR\$(18) is in place of GCOL  
CHR\$(0) is in place of 0  
and CHR\$(1) is in place of 1

So, the first four CHR\$ statements of line 60 give the foreground colour 1 (red), followed by the user defined character (224). The next three CHR\$ statements change the graphics colour

```
10 REM *** PROGRAM VI ***
20 MODE 1
30 VDU 5
40 VDU 23,224,153,66,36,153,153,36,
66,153
50 VDU 23,225,24,0,0,153,153,0,0,24
60 character$=CHR$(18)+CHR$(0)+CHR$(
1)+CHR$(224)+CHR$(18)+CHR$(0)+CHR$(2)
+CHR$(8)+CHR$(225)
70 MOVE 640,512
80 PRINT character$
90 VDU 4
100 VDU 4
```

to logical colour 2 (yellow), then CHR\$(8) performs a backspace, ensuring that CHR\$(225) overprints the first character.

We use this technique in Program VII to obtain our fairy. Line 270 adds together the string *fairy\$*, consisting of its body. This is printed over *wfairy\$* which is the fairy's body plus wings (PROCfairy, 710-780).

*fairy\$* and *wfairy\$* each consist of nine user defined characters, in a 3 x 3 grid. Actually, two of the characters of *fairy\$* (235 and 237) are completely blank. Since one variable overprints the other, I decided to keep the grid standard for easier handling.

Similarly, we print a filled-in ball, *fball\$*, followed by its outer rim, *uball\$*, on top of it (PROCballs, 590-690).

The candles are printed out as a combined string (*candle\$*) in PROCcandles (490-570).

The actual tree shape is drawn by printing three green triangles, the apexes of which overlap (PROCTriangles, 320-390). The base of the tree is drawn in PROCbase (410-470).

PROCmessage simply prints out a seasonal greeting, using VDU 5 to give a sort of 3D effect. Program VIII illustrates the technique.

What it does is to print out 'A WORD' in yellow several times, each time moving it down four graphic units to the left and down (line 60). This is because, each time through the loop, the number we reduce the X and Y coordinates by, I%, is increased by 4.

The reason we move four graphic units at a time is because this is the minimum resolution in Mode 1.

When you exit a loop, the loop variable is still incremented before the check to see if the loop should be terminated is made. So, when line 90 is reached, I% is four greater than when the loop last printed 'A WORD'. Also the colour has changed to red (line 100) so line 110 prints out 'A WORD' in red, one pixel down and to the left of the last 'A WORD'.

Try to decipher Program VII - working through other people's programs is one of the best ways to improve your own programming.

Next month, after this seasonal diversion, we'll return to the graphics straight and narrow with the GCOL statements I promised!

**Full listing on  
Page 107**

# THE BBC MICROCOMPUTER CAR BADGE

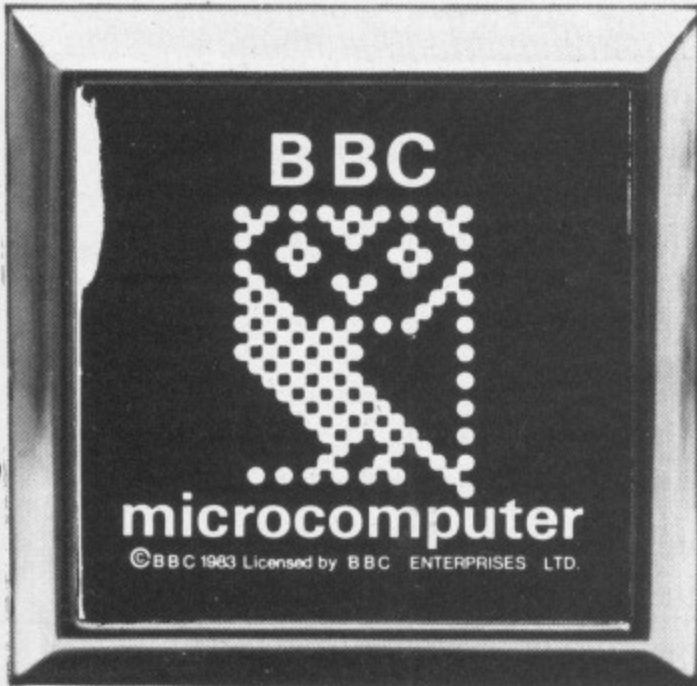

UNITED KINGDOM ONLY

- ★ COLOUR: CREAM ON DARK BROWN BACKGROUND
- ★ METAL, DIE CAST, CHROMED, ENAMEL
- ★ COMPLETE WITH BACKPLATE & GRILLE FITTINGS
- ★ BADGE BAR AND BUMPER FITTING HOLES
- ★ **MAIL ORDER £4.99 (INCLUSIVE)**

Actual size

```

*****
* Please send me ..... Badges .....
* I enclose cheque/P.O. payable to HAWTHORN .....
* Name .....
* Address .....
* .....
* Dealer Enq: 4.30pm. to 5.30pm.
* Mon-Fri. on 061-368 7793
* Send to:
* "Hawthorn", 90 Victoria Street, Hyde, Cheshire
*****
    
```

© BBC 1983 LICENSED BY BBC ENTERPRISES LTD.



**BBC  
32K**

# FINANCIAL GAMES

**AS SEEN  
ON TV**

**'Three great games, enjoyed by thousands of BBC owners throughout the world'**

Join them – don't delay order today.

## **GREAT BRITAIN LIMITED – £5.95**

Ever thought you could run the country better?

Here is your chance!

As Prime Minister and Chancellor (of the party of your choice), you have to guide the country through its social and economic ills for 5 years, then put yourself up for re-election.

*"Great Britain Ltd is easily as exciting and certainly more satisfying than any game of space invaders" – Micro User.*

*"A must for all budding politicians" – Computer Answers.*

*"Thoroughly enjoyable and worthwhile decision making activity and as such can be thoroughly recommended" – Educational Computing.*

*"Highly enjoyable" – Acorn User.*

*"A dream for Megalomaniacs" – Micro Update.*

## **INHERITANCE – £5.95**

Have you ever wondered what you'd do if you came into some money? Would you be able to invest it and watch it grow, or maybe start a small business and become a millionaire. With Inheritance you have the chance to find out.

*"A great game, really two games for the price of one" – Micro User.*

*"Well presented and good value for money" – Personal Computer World.*

## **WORLD TRAVEL GAME – £6.95**

A game for 1 or 2 players. Rush around the world collecting souvenirs. Keep your head and try to avoid Hijacks, Strikes, Thieves, Cash shortages, Bankruptcies, Bad Weather etc.

*"Exciting, competitive and even educational – not to be missed"*

**ALL THREE GAMES NOW AVAILABLE IN A SPECIAL PRESENTATION  
PACK – AN IDEAL GIFT**

**£17.95 complete**

*Available from your local computer shop or by 24hr despatch from:-*

**SIMON W. HESSEL SOFTWARE**

**(Dept. M), 15 Lytham Court, Sunninghill, Berkshire.**

**Telephone: Ascot 25179**

Please add 30p P&P on orders for single games – UNLIMITED GUARANTEE.

Dealers – Reserve your Christmas stocks NOW.

Schools and Education Authorities – special deals on multiple orders.



# Investigating what makes you tick

WHATEVER activity we are involved in, be it sitting and reading *The Micro User* or competing in a quadrathlon, our brains make sure that the body processes are maintained between fine limits.

This system of feedback, or homeostasis, involving the body organs and the brain is essential to life. At last there is a software package designed to demonstrate this vital physiology in a form intelligible to all biology students.

Physiological Simulation is an MEP subsidised biology package published by Heinemann Computers in Education. It is designed for use with pupils aged 13 and above.

The program's greatest asset is that it allows physiological investigations to occur which would not normally be within the scope of school laboratory facilities. It also allows the effect of a simple variable to be assessed in a complex physiological system.

Put simply, the user (playing the part of the brain) has to keep the body, (played by the computer) alive while performing one of a dynamic range of activities, such as running, sleeping, walking, hockey, rock-climbing and rowing.

The user begins by opting to use preset values or to input pupil details (sex, age, mass, blood volume and vital capacity), activities (already mentioned) and parameter values (breath, volume, rate of breathing and sweating rate).

Do not let the idea of measuring pupil blood volumes put you off. The detailed booklet provided has a simple-to-use nomogram which enables this variable to be quickly calculated from the subject's height and mass. Vital capacity is easily measured in class using the normal spirometer apparatus.

Once these data have been provided dynamic graphs show the person's progress over a simulated 50 minute period. A colour monitor is an advantage as the background colour changes from red to blue, while the display remains white.

Apart from a clock showing the time elapsed, graphs of oxygen debt, sugar used, oxygen supply, body temperature and water loss are all provided. A word of warning: the interpretation of the

## Physiological Simulation Five Ways Software

oxygen debt graph needs clear explanation before the simulation otherwise it is very misleading.

The user must maintain all five of these variables within displayed upper and lower limits or the activity ceases and a message indicates the reason for failure, for example "Person is DEAD"!

The secret of success is to freeze the action when the body is in danger and change either the parameters or activity. Unfortunately the axes of the graphs do not show any scale or units. This facility would make the graphical display more



intelligible and bring the software up to A-Level requirements.

Once the simulation has finished it is possible to begin the program again, terminate it or display further options such as beginning a comparative simulation for a second person. After such a comparison the user can replace any one of the two sets of data and try another comparison.

The program is well "student-proofed". It is very difficult to make an error which throws the program haywire.

Clearly such a package is of most use in a teacher demonstration situation – maybe using more than one monitor if the group is large – or possibly by the more able pupil in small well-supervised groups.

Hard copy is not provided for users. This is a pity as a printout would provide a permanent study/revision piece.

A program is only as good as the mathematical model it is based on. The medical data used was mainly derived from a Swiss sample taken in 1956-57.

One cannot help but wonder how different the pupils are today when compared with those used for the present values, but the program's saving grace is that it does allow fresh data to be inserted. The source of the calculations used to plot the graphs is not disclosed – a glaring omission.

The notes for teachers are well documented on the whole and particularly useful for teachers using computer-aided learning material for the first time. It is unfortunate that no bibliography is provided to aid teachers in background/further reading.

Visual presentation in this software package is top class. The program is fun to use, but be prepared to spend an hour or two in preparation time to master its principles first. It is not an instant lesson, nor is it designed to be one, but it is a flexible and powerful educational tool which should be in every biology teacher's "toolbox".

At £12.50 – for disc or tape – this package is good value for money and recommended for use by all secondary school biologists.

Peter Hillman



# Pardon my French...

**Essential French Verbs for the BBC Micro (32k)**  
Carsondale Enterprises

THIS program covers 83 French verbs, in three main groups according to difficulty.

The choice of verbs is, of course, largely a matter of taste but I could have thought that *absoudre, accroître, croître, assaillir, dechoir* could have been omitted and replaced with many of the common *être* verbs: *sortir, entrer,*

*monter, retourner, revenir, devenir,* which are missing and which are essential Form Five verbs.

The second option allows one to look up the verbal forms by verb. The third option allows the user to look up by tense. The tenses covered are the present, imperfect, perfect, future and conditional – the five essential tenses.

The screen is divided into two halves. The bottom explains what is happening and the top displays the conjugation of the verbs in two “windows”. Four colours are used but black and white

can be specified. This makes them somewhat easier to see.

I had looked forward to seeing the perfect tense but I was somewhat disappointed. Not only were many *être* verbs missing but also the whole range of possible past participle endings were not displayed, nor were the *elle* and *elles* form (though there is a spare line in the window).

As the conjugation of the singular is displayed side by side with the plural, there is no room to show the *nous, vous* and *ils* form of reflexive verbs (except for *se taire*) and so the effect is lost. Again the participle agreements are simplified.

Could not these forms have been shown in the other window? The forms are obviously in memory because they are tested later.

The “browse” option allows the computer to display verbal forms quickly or slowly of the group of verbs and tenses chosen. The quick option displays a conjugation about once a second which is a little fast.

The fifth option is “test”. Once again, one may choose any group(s) of verbs and any of the tenses specifying a time limit if desired. The computer is very strict and does not allow extra spaces to be typed in inadvertently. Perhaps a procedure could have been used to allow this.

It is perhaps the “retest” option which is the most novel in this program. The first 10 elements of a test may be stored in memory or recalled from cassette or disc for retest, either the whole test or just the mistakes. This seems potentially useful to the learner and a 10 element test will not lose his interest.

To sum up, a sound program and a good “verb calculator” and data base. It could however, have been more explicit in the perfect tense which is a major stumbling block for the “O” Level candidate.

## ...and German too!

**German Sentence Practice for the 32k BBC Micro**  
Educated Owl Software

THIS software cassette contains two programs. The first illustrates and gives the text of nine sentences or phrases and requires the learner to reproduce the sentences exactly.

The program causes the sentence to be shown on screen and requires him to reproduce the whole sentence. Praise is given when the sentence is correct. No score is kept.

The above bald description might indicate at first sight an expensive way of getting children to learn a few sentences, but this does not take into account the fact that the graphics, though simple, are extremely motivating and totally relevant to the sentences.

Many are animated, including a little man who enters a bank, and a little man who gets into a car. Four colours are used and the drawings are created on screen out of basic shapes – rectangle, triangle, circle – and this reveals the second level of the programming.

The manufacturers supply details for changing the text and for changing the graphics. The program is, in itself, a rich source of graphics procedures and means of tying text with pictures, and could prove of interest to the language teacher interested in programming or a colleague who could help him.

It is this possibility of extension that makes the program useful. Here, for

reference, is a translation of the nine phrases used. I give this because a “French Sentence Practice” cassette is also available, which would appear to have the same graphics.

The sentences are: 1, I’m shopping; 2, The handbag; 3, He has spent money; 4, He gets into the car; 5, He has to wait 30 minutes; 6, The big man who wanted to be small; 7, I ask for money; 8, Twenty marks (100 Fr in the French version); 9, He has gone into the bank.

The sentences come from the same shopping/town situation but have mixed tenses and persons – I suppose they represent important constructions, but the reason for the selection is not immediately clear though the same phrases occur in the second program.

The second program is a cloze type program. The learner is presented with a 150 word narrative about Mrs Gieselmann shopping (good “O” Level and CSE material) in the imperfect tense with 20 blank spaces to fill in. The learner is helped by being given the next letter if he fails to guess it after three attempts. A percentage score is given at the end.

Again, this program is on two levels – the text given and the fact that instructions are given on how to change the text and decide which words are to be blanked out. This tape can thus be considered a general purpose cloze-type program. In short, two programs with potential – motivating and with good use of graphics.

These reviews first appeared in the November 1983 issue of *Language Monthly*, and are reproduced by courtesy of Praetorius Ltd, 30 Clarendon Street, Nottingham NG1 5HQ.



# Making sweet music

THE only criticism I have of System Software's Music Editor is its name. It should be called the Music Maker because that is exactly what it is - an easily-used utility which allows you to compose tunes on your BBC Micro.

You write the tunes using two modes of operation. The first is edit mode in which the actual composing is done. The skeleton of a piece of sheet music (technically known as the bass and treble staves) appears on the screen and you can use the keyboard to enter in a tune, note by note.

When you enter a note it not only sounds but also appears on the staves in the right position with the right value. If it's not what you want then you can just press a key to delete it and try another.

It's not just the pitch of the note you can alter. The program allows you to alter the duration and loudness of the notes, simply and quickly. You can even choose the key and tempo of your tune.

And if that's not enough you can have up to three parts or "voices" to add

harmony to your composition. It may sound complicated but in practice it isn't - the software sees to that.

The second mode is the command mode and by using this you can "command" the micro to play back your masterpiece. You can have the whole tune or just a part of it and the program even allows repeats of sections of the piece. If you like what you hear you can save it for posterity. If you don't it's back to editing mode and the throws of creation! And if you need inspiration you can always load one of your previous efforts and play it.

As if all this weren't enough, when

you first run the Music Editor you get a choice of 16 ready-to-use sound envelopes. If you don't like these you can alter them easily from the keyboard or load envelopes that you have previously altered and saved.

These are just the major facilities that the program gives you. There are lots more, all useful. And if you get lost you can always press the H key and get a crib sheet.

But you shouldn't need it. The instruction booklet is excellent and the whole program an example of what is meant by "user-friendly". People with no musical knowledge may be a little daunted at first but the Music Editor is so easy to use that it encourages experiment and with it learning.

You can write tunes by ear while the display gives you the correct musical notation. It's a gift to every frustrated composer, thwarted music teacher and parent who wants to give a child something that is amusing yet educational. And it's so much fun to use!

This excellent piece of software was a pleasure to review. Thoroughly recommended.

Nigel Peters

# Physically, it's a bit of a weakling

ON loading this attractively illustrated program my first impression was one of disappointment.

As it comes from one of the more promising software producers, I had hoped for a lively and imaginative guide to physics formulae and effects.

But if you're looking for attractive graphics or even some vague degree of user-friendliness, this program offers little satisfaction.

If, however, you want a plain and simple testing-of-formulae program, Physics will probably suit you.

The program is menu driven, and offers eight options: Test, List, Formulae, Instructions, Load Data, Save Data, Add Data, and End.

With the Test option, you are given 10 questions such as:

- The power is 4.3W
- The current is 6.9A
- What is the voltage?
- Units?

You have to enter the answer and the correct abbreviation for the units. If you get the answer wrong, then in the above example, the response is "Wrong,  $4.3/6.9 = 0.623188406$ . The units of voltage are V".

Your score at each stage is displayed, and after the 10 questions it is also given as a percentage.

The full list of quantities and units is given by the List option, and consists of 28 quantities beginning with mass, density, volume and ending with resistivity, length, temperature, sine and cosine, tangent and capacitance.

The list thus covers a reasonable range of basic equations, with all the units given in the SI convention.

The Formulae option is useful for revision and allows you to enter a subject, such as "work". It then displays all the formulae relevant to that subject, in this case:

- Work = voltage x charge
- Work = power x time
- Work = force x distance
- Work = temperature x mass

If you read the section on Add Data in the instructions, this is what you see:

"You may add extra data by keying in your formulae (quantities in lower case) in the addition section. This data may then be saved and loaded from tape".

However, I find this feature very confusing and have still not managed to work out how to use it.

Presumably it lets you expand the subject range to include more varied equations and to load these as and when you need them.

This program could conceivably find a useful place in schools or for a revision aid at home for those unfortunate enough to need to recall a wide range of equations with ease.

But, sadly, it lacks the user-friendly approach which must surely be a priority for all educational software, and though probably an effective learning aid, it makes no attempt to use the BBC Micro's colour, sound or graphic facilities in any way.

Jane Jackson



Sprite-gen

DACC

HOW many times have you had a good idea for a game but found that moving large numbers of objects around the screen has slowed everything down so much that the whole thing is pointless? Well, what you obviously need are some sprites.

Sprites are picture elements that can be made to move around the screen. They are normally generated with the aid of hardware but can also be formed and moved by software. The Sprite-gen program allows you to do just that in a painless manner.

The cassette contains the sprite generator program and two example games that use ready-defined sprites. Both games are listed in the 13-page

## PHOENIX RISES YET AGAIN

Firehawks

Postern

FIREHAWKS is yet another version of Galaxians, the old arcade game. A bunch of ravenous energy-consuming Firehawks drop from the top of the screen. They are trying to get to the bottom where they will regenerate into the legendary Phoenix. As they dive they're delayed by a series of plasma fields through which they have to weave their way.

Once past these there is only your spaceship's laser canon to hold them off. This is easier said than done as there are some 225 levels of difficulty – how anyone can play the higher levels defeats me. Yet I've seen it done!

While the noises it makes are the loudest I've ever heard on the BBC Micro, the graphics aren't all that impressive and the game itself appears simple and fairly standard at first. Not much to write home about you might think.

Then you see someone playing it and immediately want to have a go, convinced that you can do better. It can get quite compulsive and, at the higher levels, exasperating. It may be simple but it's fun. So, if you want a fast, action-packed version of an old arcade favourite then this will probably meet your needs.

Eileen Young

# Genned-up on sprites

manual and I was impressed that such effective games can be written in so few statements.

The sprite generator itself is easy to use. Sprites are defined on a 7 x 8 grid and because the program uses mode 2 any of the BBC Micro's 16 colours may be used. Larger objects can be defined by linking a number of sprites in the user program.

There are 32 sprites available although numbers 0 to 7 are the main ones. The rest are known as clones. A clone normally takes on the design of its associated sprite although this can be altered.

An added degree of animation can be included by careful use of the flashing colours. The example called Chopper Chase shows this admirably.

Any sprite can be simply placed in any position by a line of Basic. It is positioned by use of integer variables assigned to that particular sprite. For example, sprite 0 is allocated A% and B%. Thus to position sprite 0 at

(640,512) you just key in:

```
100 A%=640:B%=512:
```

```
Z%=0:CALL &10A3
```

Z% contains the sprite number and the CALL merely invokes the machine code that displays the sprite. If A% or B% is updated and sprite 0 displayed again then the old image is deleted automatically. A nice addition is that by adding 256 to the sprite number that sprite is removed from the screen.

On defining a sprite two images are created, allowing smooth movement. The second image can, however, be defined to differ from the first allowing another level of animation.

Sprite-gen is a very useful utility. The examples are good to look at and fun to play. DACC have even more impressive demonstrations so it's very versatile. A minor omission is that it doesn't include a facility to detect when one sprite hits another. But that is a minor flaw in an otherwise impressive package.

Alan Plume

## Feeling a bit peckish?

Snapper

Acornsoft

SNAPPER is an attractive and incredibly frustrating version of Pacman. You have to guide a cute little yellow Snapper (complete with green hat) through the maze, gobbling dots and juicy looking cherries, strawberries and other fruits as you go.

The creatures who lurk in the cave in the centre of the maze are unfortunately trying to gobble you and, if they don't manage to corner you between them, one look at their enormous bulging eyes may well scare you rigid anyway.

Just so as not to make it too one-sided, if you eat any of the four flashing dots in the corners, you get 10 seconds in which to get your own back, and earn some bonus points as well, while the creatures are temporarily harmless.

When all the dots are eaten you tackle a new screenful. The game gets progressively faster and the value of the fruit also increases.

If you can make it to 15,000 points you earn another Snapper, and if you can get through 12 screenfuls you may get a glimpse of the ultimate prize – the Acorn.

You can play Snapper with the keyboard or with joysticks and both are good, with perhaps the joystick giving you the nearest feeling to the arcade versions.

A high-score table is included and the accompanying sound effects are very authentic.

Altogether, Snapper is one of the best versions of the game that I've seen. It's relatively easy to pick up the controls and to get fairly proficient at dot gobbling – but it's almost impossible to win.

Jane Jackson



**...CUMANA ANNOUNCE THE LAUNCH  
OF THEIR NEW DISK DRIVE  
FOR THE BBC MICRO...**



The rapidly expanding BBC Micro market now has a top quality addition, with Cumana announcing the launch of their new disk drives to the eagerly awaiting audience of BBC Micro users.

Cumana disk drives are designed and manufactured to the highest standards. They have an independent power supply, 12 months warranty, and are fully assembled and tested before packaging; and they are now available — at unbeatable value for money prices — from well known High Street outlets.

Look out for the distinctive Cumana packaging in your High Street today!

For further information about Cumana disk drives for the BBC Microcomputer, please complete and return this coupon.

Interests:  
 Home Use   
 Education   
 Dealer   
 Business

Name .....

Address .....

Tel. No.....

Note: If dealer, please attach this form to your letterheading.

**BMU12/83**



Cumana Limited, Pines Trading Estate,  
 Broad Street, Guildford, Surrey, GU3 3BH.  
 Telephone: Guildford (0483) 503121 Telex: 859380





Rescue London's stolen treasures from the  
**Phantoms of Tower Bridge**





THE GHOSTS at the Tower of London have left their usual haunts. They've taken the treasures from the vaults and scattered them all over Tower Bridge.

Your job as custodian is to gather up the treasures one by one and get them back to the bank for safe keeping.

The trouble is that the ghosts, while not harmful, are mischievous. If one catches you while you're on your way to

the bank with some treasure, it will probably take it off you and put it back on Tower Bridge. And the bridge is opening and closing all the time.

Just to make it more frustrating, as soon as you've collected all the treasures and put them in the bank the ghosts scatter them all over the bridge again.

And this time there are more of them trying to thwart you!

### Major Procedures

- 1330 **PROCinit** dimensions and sets up arrays used in program; also sets up user-defined characters and sound envelopes.
- 1500 **PROCsetup** sets up variables at start of each sheet.
- 940 **PROCscreen** sets up screen, as you might guess.
- 900 **PROCbridge** draws bridge.
- 650 **PROCman** animates man.
- 750 **PROCguard** animates each guardian ghost.
- 860 **PROCraise** raises/lowers bridge.
- 510 **PROCmanmove** reads keyboard and decides where to put man.
- 630 **PROCfall** moves falling man and finds out if he is in Thames.
- 700 **PROCthink** decides where to put ghosts.
- 1000 **PROCTower** draws towers.
- 1130 **PROChead** displays the title header.
- 1250 **PROCTell** displays instructions.
- 1560 **PROCerr** traps escape or displays any other errors.

### Major Variables

- A% = TRUE if man is dead.
- C% = TRUE if man carrying treasure.
- D% = TRUE if ghouls carrying treasure.
- K% = Ascii value of key pressed.
- M% = Number of lives left.
- N% = Number of ghost being animated.
- S% = Score to date.
- T% = Number of treasures in bank.
- U% = Height of bridge.
- X% = Man's X co-ordinate.
- Y% = Man's Y co-ordinate.
- hi% = High score.
- nc% = New character for man.
- oc% = Old character for man.
- no% = Level (number of ghosts).
- up% = TRUE if bridge to be raised.
- X%(N%) = X co-ordinate of ghost N%
- Y%(N%) = Y co-ordinate of ghost N%

**Complete listing starts on Page 127**



**THE  
MICRO  
USER**

proudly  
presents

# CHRISTMAS CRACKERS

It's the games cassette EVERY  
BBC Micro user will want to find  
in his Christmas stocking!

OUR cracking Christmas cassette contains games galore for all the family. Young or old, computer freak or novice — there's something here for everyone. The younger ones in the family will be sure to love XMAS\_SNAP and BLIND\_BUFF, where they hunt the Christmas cracker. And XMAS\_SIMON, where they have to follow the flashing lights on a Christmas tree.

The whole family will enjoy DODGE\_DAD, where you help a boy to find his hidden presents, avoiding his enraged father. Then you can try to escape from the magic MAZE that only appears as you move. If you're feeling athletic, why not try our SKI\_SLOPE or Santa's SKITTLES?

You can help Santa with his Christmas deliveries in CRAZY\_SANTA by dropping presents down the chimneys! Alternatively, you can try to pilot him safely onto the rooftops in LAND\_SANTA.

FOREST\_RUN has you guiding Santa to his sleigh, while in SNOWPUD you'll be steering the Christmas pudding through a blizzard. For those of you who leave your Christmas shopping to the last minute, you can hunt your Christmas dinner in TURKEY and collect your tree in PICK\_TREE — providing you can dodge the sleighs!

If these action-packed games prove too much for you, you can relax with our word games ANAGRAMS, WORDSEARCH, XMAS\_WORDS and HALF\_WORD, or play an intriguing game of TICTACTOE. Alternatively, you might care to test your knowledge of carols (and your reactions) with CAROL\_QUIZ. Then you can round the whole session off by playing your own carols with CHIMES, our tune-making program.

There are 21 games for just £6.95, the best buy you'll make all Christmas!



## POST NOW!

Please send me ..... copies of the Christmas Compendium at £6.95 inc. VAT (Plus 50p P&P.)

Total: £ .....

Name .....

Address .....

Signed .....

Please indicate method of payment (✓)

- Cheque      Card No.
- Access      Expiry date
- Visa

POST TO: BBC Micro User, FREEPOST, Europa House,  
68 Chester Road, Hazel Grove, Stockport SK7 5NY.

No stamp needed if posted in UK.

A compendium of  
**21**  
easy-to-play  
programs — each  
with an exciting  
festive theme



# SNOWBALL

at £9.90 is a great new adventure for:

**BBC 32K** **COMMODORE 64** **SPECTRUM 48K**

**LYNX 48K** **NASCOM 32K** **ORIC 48K** **ATARI 400/800 32K**

Snowball is a massive adventure with over 7000 locations. It took nine months to perfect and marks a new leap forward in adventure games – it has a detailed, planned background and is set aboard a huge starship that would really work. Snowball could be a glimpse of the future!

You play Kim Kimberley, security agent. Your mission is to guard the colony ship Snowball 9 from sabotage.

Thus when your freezer-coffin wakes you with the Snowball still in flight, you know that something must be very wrong. You're weakened and disorientated by lengthy hibernation, but the fate of the 5 mile long space-ship is in your hands!

Snowball is our new fourth adventure. Here's what the reviewers have just said about the first three:

"The Level 9 Adventures are superbly designed and programmed, the contents first rate. The implementation of Colossal Cave is nothing short of brilliant; rush out and buy it. While you're at it, buy their others. Too. Simply smashing!"

- *SOFT, September 83*

"Of the programs reviewed here, the only one that is wholly admirable is Level 9's Colossal Adventure."

- *Your Computer, September 83*

"I found Dungeon exceedingly well planned and written, with a fast response. There are well over 200 locations and the descriptions are both lengthy and interesting."

- *Computer & Video Games, September 83*

"This has to be the bargain of the year... If adventures are your game, then this is your adventure"

- *Home Computing Weekly, 30th August 83*

"There are three excellent adventures on offer from Level 9... the descriptions are so good that few players could fail to be ensnared by the realism of the mythical worlds where they are the hero or heroine... great fun to play."

- *Which Micro?, August 83*

## MIDDLE EARTH ADVENTURES

for the same micros as Snowball

Each of these games has over 200 locations and a host of puzzles. They can be played singly or together as an impressive trilogy. Each game could well take months to solve!

### 1) Colossal Adventure

The classical mainframe game "Adventure" with all the original puzzles plus 70 extra rooms.

### 2) Adventure Quest

An epic puzzle journey in Middle Earth.

### 3) Dungeon Adventure

Over 100 puzzles to solve as you explore the dungeons left by the Demon Lord – outwitting their guardians.

### Price: £9.90 each (inclusive)

Level 9 adventures are available from good computer shops, or mail-order from us at no extra charge. Please send order, or SAE for catalogue, describing your micro to:

### LEVEL 9 COMPUTING

Dept U 229 Hughenden Road,  
High Wycombe, Bucks HP13 5PG

Dealer  
Enquiries  
Welcome





AT the heart of the BBC Micro's graphics capability is a remarkable device called a 6845 cathode ray tube controller (CRTC). This device not only controls how the display memory is organised to give a picture on your television or monitor, but is also constantly refreshing the machine's RAM.

The 6845 has 18 registers, but this article is concerned with only two of them, R12 and R13.

These registers are "write only" and hold a 14 bit address which supplies the start address of the current display memory.

In modes 0 to 6 this value is the start address of the screen memory divided by eight. Thus in mode 4 the registers contain:

```
R12 (MSB) = ( &5800 DIV 8) DIV 256  
R13 (LSB) = ( &5800 DIV 8) MOD 256
```

New values can be written to these registers by using the VDU 23 statement:

```
VDU 23;12,hibyte;0;0;0  
VDU 23;13,lobyte;0;0;0
```

It doesn't take a lot of imagination to realise that writing other values to these registers could generate useful effects.

Here are three major uses, and I'm sure that there are many more:

- To allow fairly smooth animation of complex shapes.
- Fast sideways and up/down scrolling. Anyone who has played Rocket Raid knows how effective sideways scrolling is.
- Displaying a micro slideshow with stored frames of text or graphics on disc. While one frame is on display another can be loaded into a spare section of memory and then switched in

# Use these pages to get your images moving

By  
**ALAN PLUME**



by changing R12 and R13.

Obviously only modes 4 to 7 can be used for this, as the computer doesn't have enough RAM to support two mode 1 screens.

This is how we use these techniques for animation.

The original drawing is made in the normal memory for the appropriate mode.

While on display some pointers in the memory are altered and the next frame is actually drawn in another section of memory.

The address of the top of the new memory is written to R12 and R13 and the new frame seen. The old frame is deleted and the next frame constructed. This is then switched in. The process can be continued indefinitely.

Now let's see how all this is accomplished.

For this example mode 4 will be used. Normally the mode 4 screen uses memory locations &5800 to &7FFF, so if we use another page then that can be from &3000 to &57FF.

HIMEM must thus be established at &2FFF so that the program workspace doesn't overwrite the second page.

We also need to be able to clear both graphics pages quickly so we use a dedicated piece of assembler to do this. It's not too elegant, but works fast enough. Either page can be cleared by altering a single byte of the code.

Next we need to calculate the values

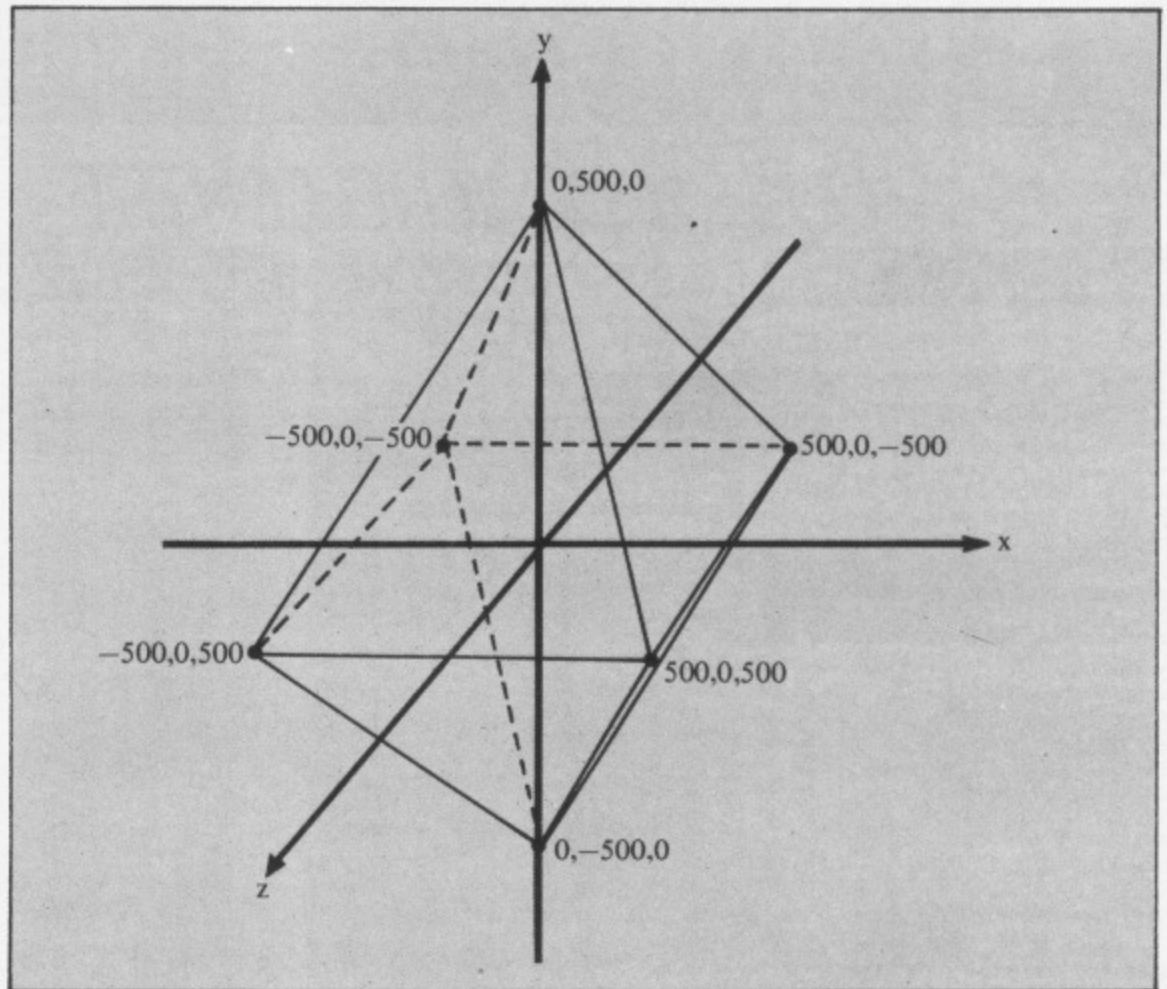

Figure 1

of registers 12 and 13 of the 6845 to allow page changes. If we consider the area from &5800 to be page 1 and that from &3000 to be page 2 then we have:

```
R12 = (&5800 DIV 8) DIV 256 = 11
R13 = (&5800 DIV 8) MOD 256 = 0
R12 = (&3000 DIV 8) DIV 256 = 6
R13 = (&3000 DIV 8) MOD 256 = 0
```

When switching pages the operating system has to know what the current

high byte of the screen start is.

This value is stored in the VDU workspace at &34E. Thus for page 2 we need to add:

```
?&34E=&30
```

and on switching back to page 1:

```
?&34E=&58
```

Now how do we tell the operating system that we want to draw on page 2?

Locations &350 and &351 appear to contain the base address that the plotting and printing routines use to place information on the screen, so we also need:

```
Page1 ?&350=0: ?&351=&58
Page2 ?&350=0: ?&351=&30
```

All this poking around in memory is exactly what Acorn tell you not to do, but if you want special effects you often have to do this.

Program I is an example of this technique used to display a wireframe cube rotating about two axes with perspective.

The program is written to allow you to put your own objects in fairly easily

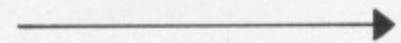



# p&h

# p&h electronics Ltd

5 THE PARADE, YATELEY  
NEAR CAMBERLEY, SURREY

TEL: YATELEY 877222

**BBC 'B'**  
**IMMEDIATE**  
**DELIVERY**

## BBC MICRO CENTRE

### BBC

BBC Model A	£299.00
BBC Model B	£399.00
BBC Model B + Disc/Int	£469.00
BBC Disc Interface	£95.00
Speech Interface	£54.00
BBC Teletext Receiver	£220.00
BBC 6502 2nd Processor	£195.00
BBC Z80 2nd Processor	£290.00
View Word Processor	£59.00
Word Wise Word Processor	£45.00
Econet Systems	P.O.A

### BBC DISC DRIVES

Acorn/LVL single 100K drive (expands to Double)	£265.00
Acorn/LVL dual 100K drive	£389.00
Pace single 100K drive	£210.00
Pace 200K drive	£250.00
Pace dual 100K drive	£370.00
Pace 40/80 switchable	£365.00
Pace dual 40/80 track switchable	
double sided drive 800K	£670.00
Cumana 100K slim	£210.00
Torch dual 400K Z80 + 64K disc pack	£897.00

### MONITORS

Microvitec 14" colour	£275.00
Hitachi 14" colour TV/Monitor	£215.00
Philips 14" colour TV/Monitor	£205.00
Sanyo 12" green monitor	£89.00

### ACCESSORIES

Cassette Decks BBC compatible	
With counter	£29.00
Without counter	£27.00
H.G. cassette leads	£4.50
H.G. Joysticks pair	£16.50
Dust cover	£5.50
R.H. Light pen	£44.00

### PRINTERS

Epson RX 80T	£305.00
Epson FX 80	£439.00
Epson RX 80FT NEW	£339.00
Seikosha GP 100A	£212.00
Seikosha GP 250 X	£275.00
Printer leads	£14.00

### BOOKS FOR YOUR BBC MICRO

Let your BBC Micro Teach you to Program	£6.45
Assembly Language Programming for BBC	£8.95
BBC: An Expert Guide (Granada)	£6.95
Advanced 6502 Programming	£10.25
Machine Code for Beginners	£5.95
30 Programs for the BBC Micro	£4.95
The Book of Listings (BBC Publications)	£6.75
The Computer Book (BBC Publications)	£6.75
Creative Graphics (Acornsoft)	£7.50
Graphs and Charts (Acornsoft)	£7.50
Forth Manual (Acornsoft)	£7.50
Lisp Manual (Acornsoft)	£7.50
Advanced 6502 Interfacing	£11.00
Programming the 6502	£9.95
6502 Software Design	£11.50
Programming and Interfacing the 6502	£14.40
Practical Programming for BBC and Atom	£5.95
Easy Programming for BBC Micro	£5.95
35 Educational Programs for BBC Micro	£6.95
Further Programming for BBC Micro	£5.95
Programming for BBC Micro	£6.50
Learning to use the BBC Micro	£4.95
Basic Programming on the BBC Micro	£5.95
21 Games for the BBC Micro	£5.95
30 Hour BASIC	£5.95
BBC Micro Revealed	£7.95
Games BBC Micro Play	£6.95

### SOFTWARE FOR YOUR BBC MICRO

#### GEMINI Business Software

Cash Book Acc.	£95.00
Beeb Calc.	£19.95
Inv. & Statements	£19.95
Commercial Acc.	£19.95
Mailing List	£19.95
Database	£19.95
Stock Control	£19.95
Home Accounts	£19.95
Word Processor	£19.95

#### ACORNSOFT

Business Games	£9.95
Tree of Knowledge	£9.95
Peeko - Computer/Manual	£9.95
Algebraic Manipulation	£9.95
Creative Graphics Cassette	£9.95
Graphs and Charts Cassette	£9.95
Desk Diary/Manual	£9.95
Lisp Cassette	£16.85
Forth Cassette	£16.85
Philosophers Quest	£9.95
Sphinx Adventure	£9.95
Castle of Riddles	£9.95
Monsters	£9.95
Snapper	£9.95
Planefold	£9.95
Arcade Action	£11.90
Rocket Raid	£9.95
Meteors	£9.95
Arcadians	£9.95
Sliding Block Puzzles	£9.95
Cube Master	£9.95
Super Invaders	£9.95
Missile Base	£9.95
Starship Command	£9.95
Countdown/Doom	£9.95
Snooker	£9.95
Number Balance	£9.95
Word Sequencing	£9.95
Word Hunt	£9.95
Missing Signs	£9.95

### MICROPOWER

Moonraider (B)	£7.99
Swoop (B)	£7.99
Alien Destroyer (B)	£7.99
Galactic Commander (B)	£7.99
Timetrek (B)	£7.99
Laser Command (B)	£7.99
Spacemaze (B)	£6.85
Astro Navigator (B)	£5.70
Maze Invaders (B)	£5.70
Startrek	£10.30
File	£6.85
Constellation (B)	£6.85
Disassembler	£6.85
Micro Budget	£6.85
Killer Gorilla (B)	£7.99
Croaker (B)	£7.99
Chess (B)	£7.99
Chess	£5.70
Barrage (B)	£7.99
Footer (B)	£7.99
Labyrinths of Lacoshe (B)	£7.99
Adventure	£7.99
Painter (B)	£6.85
Cowboy Shootout (B)	£6.85
Munchyman	£6.85
Caveman Adventure	£6.85
Seek	£6.85
Eldorado Gold (B)	£6.85
Roulette (B)	£5.70
Reversi 1	£5.70
Reversi 2 (B)	£5.70
Yahtzee (B)	£5.70
Wall (B)	£5.70
Mastermind	£5.70
Draw	£10.30
Where	£6.85
Chemistry	£6.85
World Geography	£6.85
Junior Math Pack	£6.85
Physics	£6.85
Moon Base Alpha	£7.99

### BUG BYTE

Space Pirates	£8.00
Space Warp	£9.00
BBC Dragon Quest	£11.50
BBC Fruit Machine	£5.50
BBC Chess	£8.00
BBC Backgammon	£8.00
BBC Multifile	£15.00
Space Invaders	£7.50
Galaxy Wars	£7.50
City Defence	£7.50
Synthesizer	£9.50
Sea Lord	£7.50
Oblivion	£7.50
Old Father Time	P.O.A.
Graphics Package	£9.50

### SUPERIOR

Galaxians	£7.95
Centipeds	£7.95
Invaders	£7.95
Space Fighter	£7.95
Alien Dropout	£7.95
Fruit Machine	£7.95
Frogger	£7.95
Road Runner	£7.95
Pontoon	£6.95
Cribbage	£6.95

### BBC

Home Finance	£10.00
Early Learning	£10.00
Music	£10.00
The Computer Prog. (Vol. 1)	£10.00
The Computer Prog. (Vol. 2)	£10.00
Painting	£10.00
Drawing	£10.00
Games of Strategy	£10.00
Fun Games	£10.00

**SUPPLIERS**  
**TO EDUCATION**  
**AUTHORITIES FULL**  
**SERVICE SUPPORT**  
**WITH SYSTEM**  
**UPGRADE**

**ACORN**  
**ELECTRON**  
**£199.00**  
**ORDER NOW**

**FAST MAIL SERVICE—SAME DAY DESPATCH ON ITEMS IN STOCK**

### MAIL ORDER COUPON

Please send me:

1	4
2	5
3	6

I enclose cheque /P.O. for

Or please debit my Access/Barclaycard/Visa\* (delete as applicable)

Card Number \_\_\_\_\_ Expiry date \_\_\_\_\_

Name \_\_\_\_\_

Address \_\_\_\_\_

Telephone \_\_\_\_\_

**P&H ELECTRONICS LIMITED**  
Unit 3 · Hogwood Lane · Finchampstead · Berkshire RG11 4QW

**CARRIAGE COSTS**—Micro's, Monitors, Disc Drives, Printers £6.  
Books, Cassette Decks, Leads, Software 50p.

ACCESS, BARCLAYCARD VISA ORDERS WELCOME

**CREDIT FACILITIES**  
Instant credit up to £1,000. Deposit 10%

B12





### From Page 59

by altering the DATA statements at lines 3000 and 3010.

The first set of data contains the number of points defining the object and its x, y and z co-ordinates. The second data set contains the number of lines and the linkages for these lines.

To illustrate this is a diagram of a three dimension diamond shape and the

associated data statements. (Note that the z-axis is the axis coming out of the screen.)

```
3000 DATA 6, -500, 0, 500, -500, 0,
-500, 500, 0, -500, 500, 0, 500, 0,
500, 0, 0, -500, 0
3010 DATA 12, 1, 2, 2, 3, 3, 4, 4, 1,
1, 5, 2, 5, 3, 5, 4, 5, 1, 6, 2, 6, 3,
6, 4, 6
```

The rotation procedure at lines 1500 to 1520 is also designed to allow the user to alter the axes of rotation, and even the angles of rotation. The parameters A11 to A33 are initialised in PROCsetup. As an example, to rotate about the z-axis only:

```
1620 A11=C:A21=S:A31=0
1625 A12=-S:A22=C:A32=0
1630 A13=0:A23=0:A33=1
```

```
10 MODE 4
20 HIMEM =&2FFF
60 VDU 29,640;512;23;B202;0;0;0;
70 *FX4,1
80 PROCass
90 PROCpts
100 PROClines
110 PROCsetup
150 REPEAT
160 PROCDtwod
170 PROCpage1
190 PROCrotall
200 PROCDtwod
210 PROCpage2
220 PROCrotall
230 UNTIL FALSE
680 DEF PROCDtwod
690 REM Convert to 2D coords.
700 FOR CX=1 TO PX
710 D=2500/(DX-Z(CX))
720 UX(CX)=X(CX)*D
730 VX(CX)=Y(CX)*D
740 NEXT
750 ENDPROC
760 DEF PROCpage1
770 ?&34E=&58
: ?&350=0
: ?&351=&58
780 PROCdraw
830 VDU 23;12,11;0;0;0;23;13,0;0;0;0;
840 ?(repeat+2)=&30
:CALL clg
850 ENDPROC
1210 DEF PROCpage2
1220 ?&34E=&30
: ?&350=0
: ?&351=&30
1240 PROCdraw
1260 VDU 23;12,6;0;0;0;23;13,0;0;0;0;
1270 ?(repeat+2)=&58
:CALL clg
1280 ENDPROC
1500 DEF PROCrotall
1501 FOR CX=1 TO PX
1505 X=X(CX)
:Y=Y(CX)
:Z=Z(CX)
1510 X(CX)=X*A11+Y*A12+Z*A13
1512 Y(CX)=X*A21+Y*A22+Z*A23
1515 Z(CX)=X*A31+Y*A32+Z*A33
1517 NEXT
1520 ENDPROC
1550 DEF PROCdraw
1555 FOR CX=1 TO LX
1560 JX=SX(CX)
:KX=EX(CX)
1565 MOVE UX(JX),VX(JX)
1570 DRAW UX(KX),VX(KX)
1580 NEXT
1590 ENDPROC
1600 DEF PROCsetup
1605 DX=5000
1610 A=PI /30
1615 C=COS (A)
:S=SIN (A)
1620 A11=C+C
:A21=S+C
:A31=-S
1625 A12=-S
:A22=C
:A32=0
1630 A13=A21
:A23=S+S
:A33=C
1635 ENDPROC
1700 DEF PROCass
1705 REM Assemble clear graphics
code.
1710 DIM FX 30
1720 IOPT 2
1725 .clg LDA#0
1730 LDX#0
1740 LDY#40
1745 .repeat STA&5800,X
1750 INX
1755 BNE repeat
1760 INC repeat+2
1765 DEY
1770 BNE repeat
1775 RTS
1780 J
1785 ENDPROC
1800 DEF PROCpts
1805 REM Read in points data.
1810 READ PX
1815 DIM X(PX),Y(PX),Z(PX),UX(PX)
,VX(PX)
1820 FOR CX=1 TO PX
1825 READ X(CX),Y(CX),Z(CX)
1830 NEXT
1835 ENDPROC
2000 DEF PROClines
2005 REM Read in lines data.
2010 READ LX
2015 DIM SX(LX),EX(LX)
2020 FOR CX=1 TO LX
2025 READ SX(CX),EX(CX)
2030 NEXT
2035 ENDPROC
3000 DATA 8,-500,500,500,500,500
,500,500,-500,500,-500,-500
,500,-500,500,-500,500,500,-500
,500,-500,-500,-500,-500,-500
3010 DATA 12,1,2,2,3,3,4,4,1,1,5
,2,6,3,7,4,8,5,6,6,7,7,8,8,5
```

Program 1



# MICRO POWER ARE TOP OF THE CLASS!

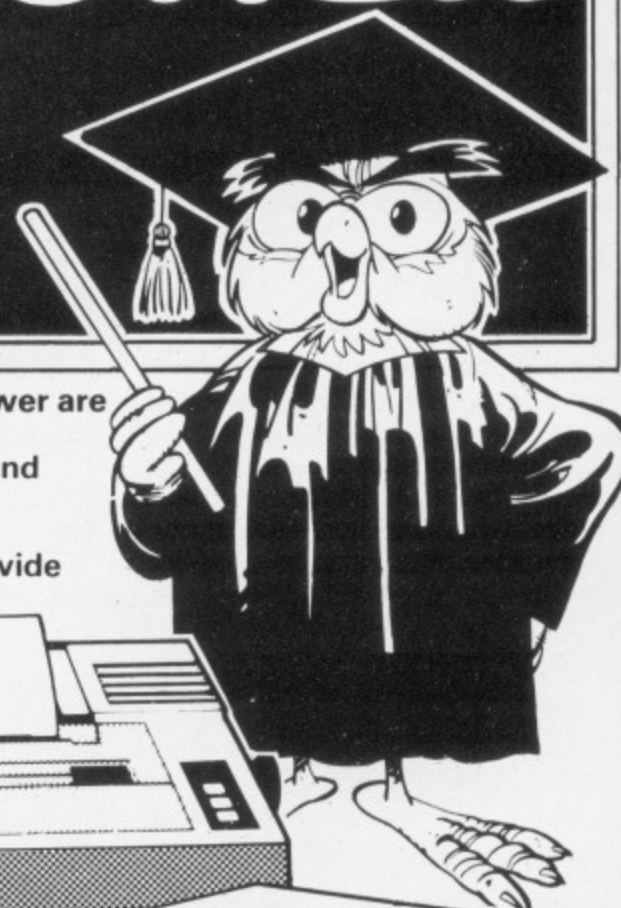

... AND WE'VE WORKED HARD TO BE THE BEST! Micro Power are an official service and information centre, and we are major suppliers to Government and educational establishments, and stock the complete range of Acornsoft and Program Power software as well as a wide range of B.B.C. Micro and general computing books. Our expert staff are always on hand to provide advice and assistance in the relaxed atmosphere of our showroom.

### COMPUTERS

Electron (Carriage £5)	199.00
(Phone for availability)	
BBC Model B	399.00
BBC Model B with Disk Interface	469.00

### MONITORS

Microvitec 14" colour	247.25
Microvitec 20" colour	343.85
Kaga 12" b & w	123.05

### PRINTERS

Epson FX80	458.85
Epson RX80	342.70
Epson MX80 III F/T	399.00
Olivetti Spark Jet	399.00
Seikosha GP100A	229.00
NEC PC8023	373.75
Parallel Printer Cable	15.50
Standard 10" tractor feed fanfold paper (per 1000)	9.20
Epson refill ribbons	3.39
Epson MX80 Dust Cover	4.50
Epson FX80 Dust Cover	4.50

### DISK DRIVES

TEAC 40 track (100k)	228.85
TEAC 40 track (200k)	424.35
TEAC 80 track (200k)	327.75
TEAC 80 track (400k)	569.25
TEAC 80 track double sided (400k)	396.75
TEAC 80 track double sided double drive (800k)	711.85
TEAC CS55ES 40/80 track 100/200k (switchable)	374.90
TEAC CD55ES 40/80 track 200/400k (switchable)	626.75
TEAC connecting cable	17.25
Acorn 40 track (100k)	264.50
Acorn 80 track double sided double drive (800k)	803.85
Torch 80 track double sided double drive, 64k, Z80 & CPN operating system plus software	P.O.A.
Shugart 40 track (100k)	263.35
additional drive for above (100k)	163.30

CARRIAGE FOR ELECTRON £5, B.B.C. MODEL B, PRINTERS, MONITORS, DISK DRIVES, FREE, BOOKS AND SOFTWARE ONLY 55p PER ORDER.

Send an SAE for our complete listing of hardware, software and books. ACCESS and BARCLAYCARD welcome.



MAIL ORDER ADDRESS:  
DEPT. BMU12  
8/8a REGENT STREET  
CHAPEL ALLERTON  
LEEDS LS7 4PE  
Tel: (0532) 683186 or 696343

SHOWROOM ADDRESS:  
NORTHWOOD HOUSE  
NORTH STREET  
LEEDS LS7 2AA  
Tel: (0532) 458800

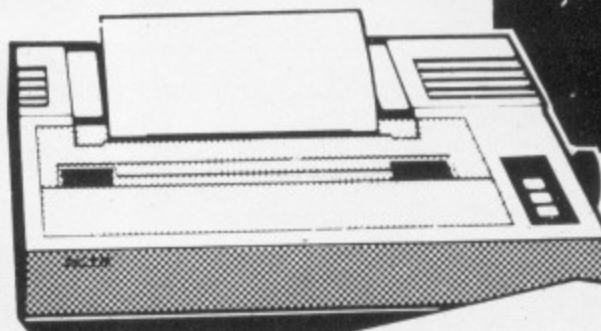

**FOUR FREE PROGRAM POWER CASSETTES WITH EVERY MODEL B**

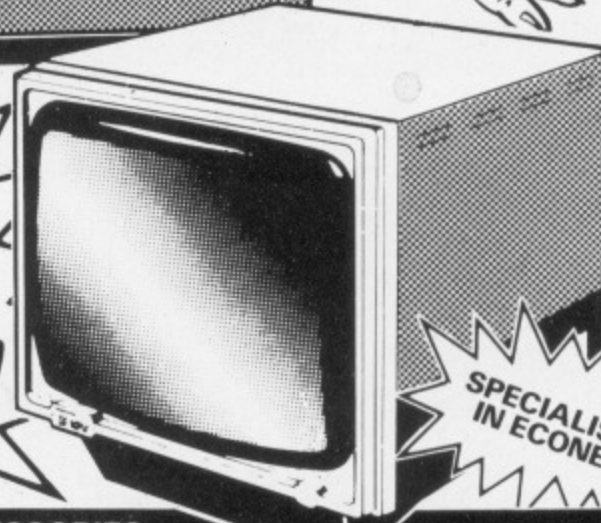

**SPECIALISTS IN ECUNET**

### ACCESSORIES

Concept Keyboard	79.35
Cable for above	20.70
Acorn Joysticks (pair)	13.00
Canvas cover for BBC	3.95
Vinyl cover for BBC	4.50
Complete upgrade	85.00
VIA chip	4.95
Buffer chip LS244	1.25
26-way connector	2.45
Disk interface (including fitting)	97.00
Econet Interface	70.00
3 C12 Cassettes	2.13
3 C15 Cassettes	2.24
3 C20 Cassettes	2.53
SS/SD Diskettes	2.88
DS/DD Diskettes	4.03
Wordwise	45.43
View	59.80
Speech Synthesiser	55.00
Beebpen	45.94
Kisho cassette recorder	19.95
Acorn BBC Recorder	29.90

**MICRO POWER - PUT TO THE TEST WE'LL PASS WITH HONOURS!**







# MICROAGE - LONDON'S PREMIER

More an experience than a computer shop.

• A complete range of games, application and business software.

• Friendly assistant to offer help and advice when you request it.



• A library of books that give specific or general information.



## The Acorn Expert

If you are thinking of buying a BBC Micro or the amazing new Electron, then come to Microage and benefit from our experience. We have been a dealer practically since Acorn started. In fact we have been selected by Acorn to be the *official* London Distributor. This means we get the latest products in quantity first.

## The Amazing Acorn Electron - In Stock Now!

We have stocks of Acorns new Electron and all Acornsoft software. Come and buy one now. £199.

## ! £ Bargain of the Month £ !

BBC micro with Disk Interface, 800K disk drive, work processing ROM, Epson or Juki printer, dust covers, Basic Programming book, leads, paper and cables. Free carriage. Normal price £1,748. Save £149. Our price £1,599.

## A Selection from Acornsoft

Snooker, Starship Command, Missile Base, Draughts and Reversi, Acardians all £9.95  
Personal Money Management, Arcade Action £11.90  
View £59.95  
BCPL £99.95

## A Selection from Computer Concepts

Wordwise, Beebcalc £39.95  
Disk Doctor £33.00  
Termi price on application  
Chess, Android Attack, Swarm all £8.95

## Some of our books

Easy Programming for BBC £5.95  
Basic Programming on the BBC micro £5.95  
Assembly Language Programming for BBC £8.95  
Discovering BBC Machine Code £6.95  
Creative Graphics, Graphs and Charts, LISP and FORTH all at £7.50  
30 hour BASIC £5.95  
BBC Micro Expert Guide £5.95

## BBC Machines

Model A, 32K RAM and 6522 £329  
Model B £399  
Model B + Disk interface £494  
BBC dust cover £3.95

## Disk Drives

BBC compatible single disk drive (100K) £235  
BBC compatible dual disk drive (200K) £389  
BBC compatible single slimline (400K) £399  
Verbatim single sided diskettes 10 for £22.50  
Verbatim double sided diskettes 10 for £39.95

## Monitors

14" RGB Microvitec Colour Monitor inc. lead. (As used in BBC Computer prog.) Price dramatically reduced to £245  
Microvitec medium res. colour monitor. Price cut to £429.95  
12" Zenith High res. green screen monitor. £95  
The new model at BNC Cable £4.95



# HOME COMPUTER DEALER

If you are interested in joining the home computer revolution or adding to your present system, then come along to Microage. In a relaxed atmosphere you can browse through the best selection of computer products and peripherals in London. Helpful assistants who really know about the products offer unbiased advice to help you choose a personal computer or get the best out of your own.



• The Microage Space Station, you're always in command. Sit at the controls and you'll see everything laid out neatly before you.

There's room for your printer, monitor, keyboard, cassette recorder and disk drives – and a handy draw for programs and manuals.

The Microage Space Station takes off for just £49.95

## Printers

Seikosha AP – 80A now	£189
Seikosha AP – 100A now	£215
Star DP510	£299
Epson FX – 80	£430
Epson MX – 100	£460
Juki 6100 Daisywheel	£430
All printers include paper and cable.	
Printer Cable	£13
10" listing paper, 2000 sheets	£16.50

## Miscellany

RH Electronics colour light pen	£39.95
BBC Compatible Cassette Player	£29.95
DIN to Jack Lead	£2
APTL ROM Board	£43.70
Official joystick per pair	£13
10 Blank C12 tapes	£3.95



• Business computers too!

• A complete range of personal computers.

## Computer Users Data File

If you can't make it to the shop you don't have to miss out on our prices and services. Just write for our Computer Users Data File. 24 fact-packed pages of current stock and prices.



## Microage Discount Card

Why not ask for our discount card guaranteeing you 5% discount off everything after your first purchase. All items subject to availability.

## Institutional and Educational

Microage offer very competitive rates and quotations for quantity orders on all equipment including Econet networks. We have four years experience of supplying and servicing Acorn equipment in schools, polytechnics and universities.

## POSTAGE RATES

Small items such as Ribbon, books and software:– 1 item £1.00, 2 items or more 50p per unit.

## BY COURIER TO YOUR DOOR

Large items such as Computer Disk Drives and Monitors:– 1 item £7, 2 items £10, 3 or more £13.

Barclaycard and Access welcomed. All prices include VAT.

**MICROAGE ELECTRONICS**  
135 HALE LANE EDGWARE MIDDLESEX HA8 9QP  
TEL: 01 959 7119 TELEX 881 3241



# Two Smash Hit Games

## The ultimate in excitement and entertainment from Softspot

### TRANSISTORS REVENGE



#### TRANSISTORS REVENGE

by Chris Butler

Your BBC Micro is under attack! The components on the circuit board are attacking the CPU. Can you stave off the many marauders by firing pulses of electricity along the data lines of the 6502. Beware of the deadly mains spikes zipping along the tracks and hit the tools on the edge of the circuit for bonus points. For emergencies only the ZAP button will destroy everything with an explosion of debris.

Features include fast smooth multi-coloured characters, 8 types of component, 4 types of tools, increasingly difficult track patterns, multiple firing, interrupt driven graphics, sound effects, high scores, bonus etc.

#### HEIST by Marcus Altman

"Look out investors your local bank is being robbed!" Manoeuvre the bank manager around the building, collecting money bags and returning them to the vault - Dodge the ever chasing robbers or bop them on the head with a hammer. Beware of the time bomb which you must defuse or you will sprout wings and fly to heaven.

Enjoy a refreshing cup of tea for bonus points, game increases with difficulty on each level. Features include fast smooth multicoloured characters, excellent sound effects, background music. Very addictive and fun.

### HEIST



ALL PROGRAMS RUN ON ALL CURRENT O.S. AND BASICS

PRICES:  
Cassette  
£6.95 each  
Disk  
£9.45 each  
All prices inclusive.

ALL TAPES GUARANTEED.  
TRADE ENQUIRIES WELCOME.

Ask for a demo at your nearest dealer.  
We pay 30% royalties for best M/C games

**SOFTSPOT**

29 SOUTH CRESCENT  
PRITTEWELL  
SOUTHEND  
ESSEX SS2 6TB



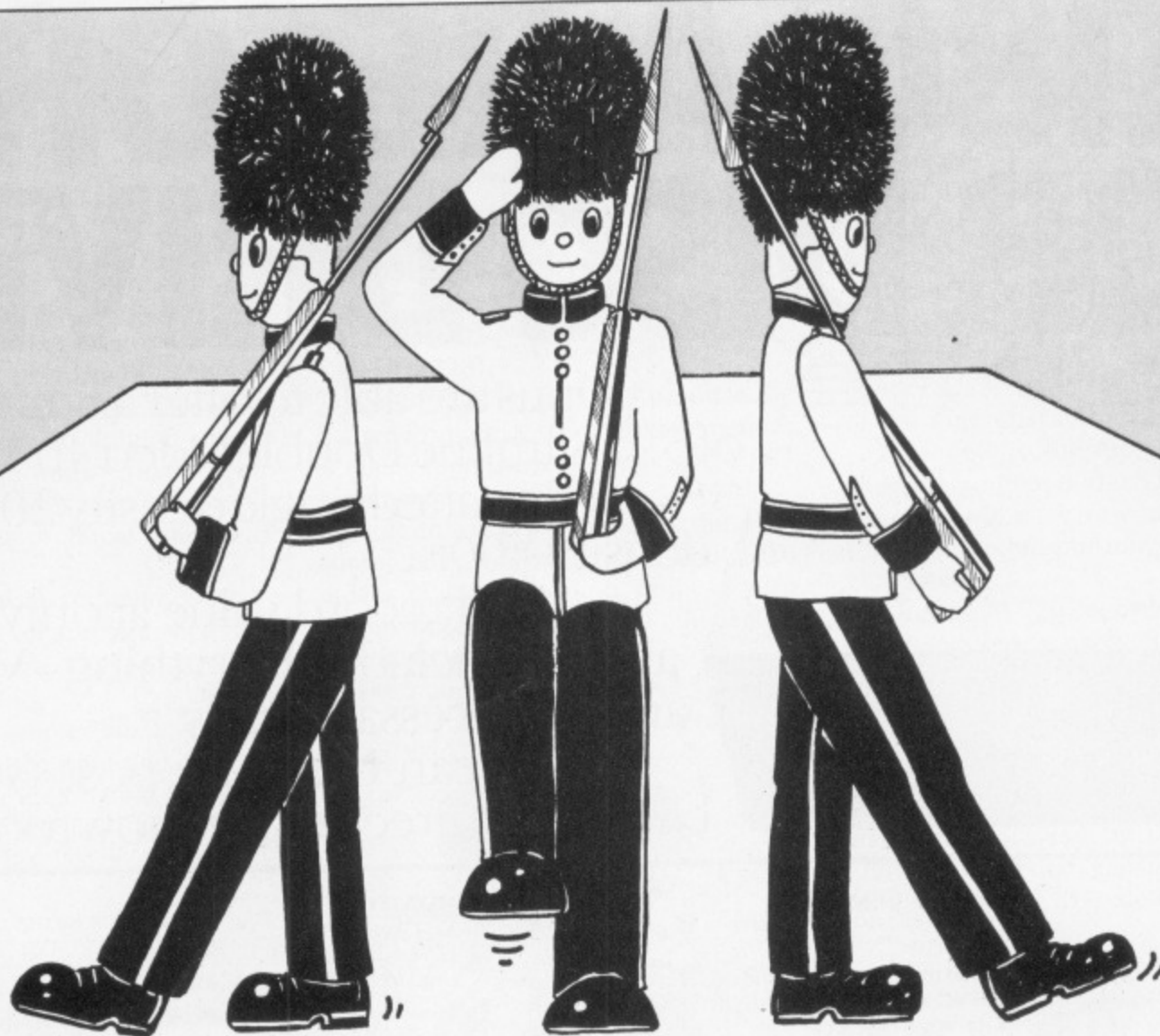

# BY THE LEFT (PROGRAM) QUICK MARCH!

THIS program is designed to take the tedium out of defining and manipulating user definable characters and allows any number from 1 to 9 to be redefined at the same time.

The characters are displayed as a block of 3x3, so they may be nine individual shapes or one large one. The whole block may then be manipulated into other orientations, and the program will produce the necessary commands.

The manipulations of the block allowed by the program are:

1. Rotate right.
2. Rotate left.
3. Mirror image (left to right).

There is no limit to how many times each may be carried out, so a great variety of orientations is available. For example, a double rotation right or left will give an inversion.

The characters displayed may be edited at any time, so if the characters are defined and rotated and a change is required in the new orientation, it can be easily carried out and the com-

mands for the new shape will be produced.

The mirror image facility is particularly useful. If characters are drawn to create a man walking from left to right the computer will give the commands needed. Then by using the

**By  
MICHAEL  
MURRAY**

mirror image, the commands needed to walk in the opposite direction will be produced with no additional effort.

Similarly, the commands to make him walk up the side of the screen may be produced using rotate and mirror image.

When the program is run the user will be presented with a grid representing 3x3 characters, sub-divided into the individual pixels. A cursor will appear in the top left hand pixel, and this may be moved anywhere in the grid using

the cursor control keys.

When the cursor is at the correct position the pixel may be set by pressing COPY. To draw a continuous line the COPY key can be held down while the cursor keys are operated.

A diagonal line may be drawn by using two cursor keys at the same time. Any pixel may be unset by moving the cursor to it and pressing Delete. Lines may be deleted by holding the Delete key down while operating the cursor keys.

It is not necessary to use all the characters available, only as many or as few as are wanted. When the characters are completed to the user's satisfaction pressing Return will cause the cursor to disappear.

After a short pause, during which the computer is doing its calculations, the commands that have been used to produce the characters that have been drawn will appear, each character





# £180: A RECORD FOR DISC DRIVES?

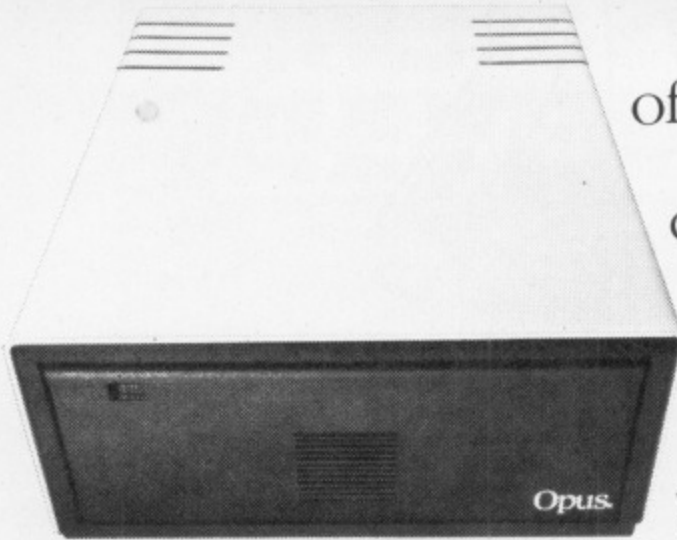

Opus are able to offer a limited quantity of 5 1/4" Slimline Double Sided 40 Track Drives. Formatted single density 200K., double density 400K.

And record value at only £179.95 and that includes everything - VAT, carriage and all necessary leads.

You can order by post (see coupon below) or direct at our showroom.

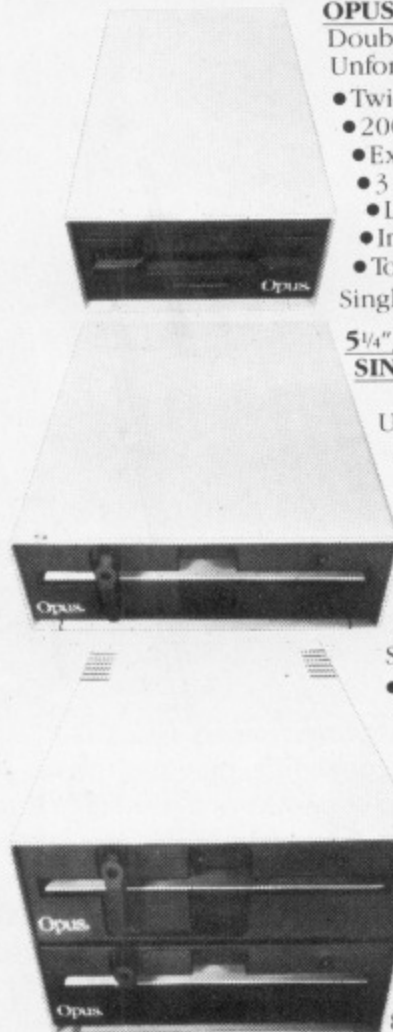

#### OPUS 3" MICRODRIVE.

Double Sided 40 Track Drive 1/2 Megabyte Unformatted.

- Twice the capacity on line of other available drives
- 200K. Single Density - 400K. Double Density
- Ex-stock delivery
- 3 ms. access time
- Lowest power consumption - direct drive
- Includes case, leads and utilities disc
- Totally compatible with 5 1/4" drives

Single Drive **£229.95.** Dual Drive **£459.95.**

#### 5 1/4" JAPANESE DISC DRIVES. SINGLE DRIVE.

Opus 5401 Single Sided 40 Track - 250K. Unformatted. Formatted: 100K. Single Density, 200K. Double Density **£179.95**

Opus 5402 Double Sided 40 Track - 500K. Unformatted. Formatted: 200K. Single Density, 400K. Double Density **£229.95**

Opus 5802 Double Sided 80 Track - 1 Megabyte Unformatted. Formatted: 400K. Single Density, 800K. Double Density **£299.95** Switchable 80/40 Track.

- 1/2 Height
- Includes case, leads and utilities disc
- Fast access time
- State of the Art Technology
- Ex-stock delivery
- Low power consumption

#### DUAL DRIVES.

All Dual Drives are metal cased with separate power supply.

Opus Dual 5401D. Single Sided 40 Track, 200K./400K. on line **£379.50**

Opus Dual 5402D. Doubled Sided 40 Track, 400K./800K. on line **£459.95**

Opus Dual 5802D. Double Sided 80 Track, 800K./1.6 Megabyte on line **£599.95**

#### MONITORS.

12" Green Screen **£89.95**

12" Amber Screen **£99.95**

Lead to connect to BBC Micro **£3.95**

• Ex-stock delivery • 24MHz Bandwidth • Limited quantity

14" JVC Colour Monitor - Med. Res. **£187.39**

14" JVC Colour Monitor - High Res. **£279.39**

#### THE ORGANISER DESK.

- Top shelf for Monitor/Printer
- Large Desk Top Area
- Lower Shelf for Paper/Book Storage
- Teak Finish
- On Casters
- Self Assembly
- Ample room in front of the shelf for you to sit comfortably. Only **£59.95**



#### FLOPPY DISCS.

3" Cartridges **£5.75** each or **£25.95** for 5.

5 1/4" Discs - with full 5 year warranty + free plastic library case.

S/S/S/D **£19.95** for 10

S/S/D/D **£23.95** for 10

D/S/D/D **£26.95** for 10

8" Discs.

S/S/S/D **£21.50.**

S/S/D/D **£28.50.**

D/S/D/D **£29.95.**

#### OPUS SUPPLIES LTD.

158 Camberwell Road, London SE5 0EE.

Tel: 01-701 8668, 01-703 6155.

#### STOP PRESS.

Double Density filing system available.

Opening hours: 9.00-6.00 Monday-Friday, 9.00-1.30 p.m. Saturday.

**GOVERNMENT & EDUCATION DISCOUNTS GIVEN. QUANTITY DISCOUNTS GIVEN. DEALER ENQUIRIES INVITED.**

To: Opus Supplies Ltd., 158 Camberwell Road, London SE5 0EE. Please send me:

\_\_\_ 5 1/4" Slimline Drive(s) £179.95 (each) (inc. VAT, carriage and all leads).

Opus 3" Microdrive(s) at:  
\_\_\_ Single Drive £229.95 (each)  
\_\_\_ Double Drive £459.95 (each)

5 1/4" Japanese Disc Drive(s) at:  
\_\_\_ Opus 5401 £179.95 (each)  
\_\_\_ Opus 5402 £229.95 (each)  
\_\_\_ Opus 5802 £299.95 (each)  
\_\_\_ Opus Dual 5401D £379.50 (each)  
\_\_\_ Opus Dual 5402D £459.95 (each)  
\_\_\_ Opus Dual 5802D £599.95 (each)

Monitor(s) at:  
\_\_\_ 12" Green Screen £89.95 (each)

\_\_\_ 12" Amber Screen £99.95 (each)  
\_\_\_ Lead to connect to BBC Micro £3.95 (each)  
\_\_\_ 14" JVC Col. Mon. Med. Res. £187.39 (each)  
\_\_\_ 14" JVC Col. Mon. High Res. £279.39 (each)  
\_\_\_ Organiser Desk(s) at only £59.95 (each)

Floppy Disc(s) at:  
\_\_\_ 3" Cartridges £5.75 (each) or 5 for £25.95  
\_\_\_ 5 1/4" Discs  
\_\_\_ S/S/S/D £19.95 for 10  
\_\_\_ S/S/D/D £23.95 for 10  
\_\_\_ D/S/D/D £26.95 for 10  
\_\_\_ S/S 80 Track £29.00 for 10  
\_\_\_ D/S 80 Track £31.95 for 10  
\_\_\_ 8" Discs  
\_\_\_ S/S/S/D £21.50 for 10  
\_\_\_ S/S/D/D £28.50 for 10  
\_\_\_ D/S/D/D £29.95 for 10

#### All prices include VAT and carriage.

I enclose a cheque for £\_\_\_\_\_. Or please debit my credit card account with the amount of £\_\_\_\_\_. My Access/Barclaycard (please tick) No. is \_\_\_\_\_

Name \_\_\_\_\_

Address \_\_\_\_\_

Telephone \_\_\_\_\_

**Opus.**  
Opus Supplies Ltd.  
BU3



**From Page 67**

being drawn alongside the relevant command.

At the bottom of the screen the whole block will be printed in two forms. The first is the form of the block in 40 column mode and the second is as it will appear in 20 column mode. After the commands have been examined, and noted if required, pressing the Space bar produces a menu to allow:

- A. Start again from scratch.
- B. Re-draw the characters just defined (in case changes are wanted)
- C. Rotate the whole block of characters to the right and display them on the original grid.
- D. Rotate to the left and display.
- E. Create and display a mirror image.
- F. Exit from the program.

When options B-E are selected the resulting display may be edited using the cursor keys, Copy and Delete. Pressing Return will then produce the commands for the amended display.

If options C-E are selected pressing Return without editing will produce the commands for the original characters in the new orientation.

The redefinable characters used in this program are 224-232, as shown in Figure I, but there is no reason why these need to be used.

224	225	226
227	228	229
230	231	232

**Figure I**

It is the parameters which follow that are important, and these may be used in a VDU23 statement to redefine any character required by the user to give the shape that he has drawn.

If the whole block is to be treated as a single figure it may be printed as a compound VDU statement, for example:

```
VDU224, 225, 226, 8, 8, 8, 10,
227, 228, 229, 8, 8, 8, 10, 230,
231, 232
```

This is demonstrated in line 900 of the listing. However if this is to be done frequently it is better to assign the whole figure to a string.

For example, if a figure has been drawn using the four top left hand characters:

```
FIG$=CHR$(224) + CHR$(225)
+ CHR$(8) + CHR$(8) +
CHR$(10) + CHR$(227) +
CHR$(228)
```

Thus PRINT FIG\$ will produce the figure. Printing a string in this manner is faster than using a compound VDU statement.

Note that CHR\$(8) moves the print cursor back one space and CHR\$(10) moves it down one line. If these were not included the figure would appear in a straight line.

The main program is lines 130-200. Line 150 dimensions the array into

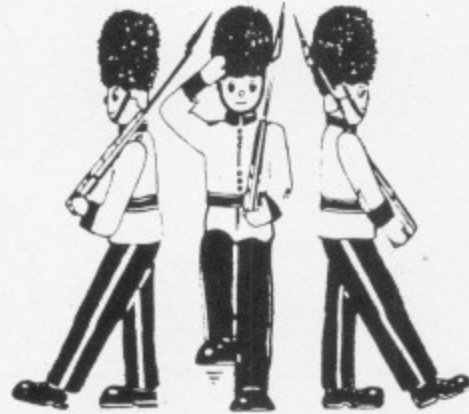

which the parameters for each character are to be placed, that is characters 0-8, parameters 0-7.

Lines 160-180 draw the initial figure and produce the commands while line 190 enables repeated changes and manipulations to be made.

PROCGRID draws the basic grid. Each grid square is 40x40, so that when a pixel is filled with a 32x32 character the grid lines are preserved.

Line 260 is to print the lines representing character positions in white and those representing pixels in red.

Line 340 defines the cursor and 350 the pixel filler character.

PROCDRAW is the procedure to draw the characters. Lines 420-430 place the cursor in the top left of the grid. Lines 440-580 control drawing until Return is pressed.

Line 450 is a time delay that can be altered to suit the user. Line 460 stores the current cursor position. Lines 470-500 calculate the new position according to which cursor keys are being pressed, and lines 510-520 keep the cursor within the grid.

Line 530 deletes the cursor from its old position. Lines 540 and 570 draw it in the new position.

Line 550 deletes any pixel in the new

position if Delete is pressed, while line 560 sets the pixel if Copy is pressed.

Line 590 removes the cursor after Return has been pressed.

PROCCOMMANDS examines the grid to determine which pixels are set and calculates the parameters required in a VDU23 statement to produce each of the nine characters.

Line 660 is for the three rows of characters, line 670 is for the three characters in each row and line 680 is for the eight parameters in each character.

Lines 690-720 convert the binary representation of each character into a number, the left hand pixel of each row of each character being worth 2<sup>7</sup>, decreasing to 2<sup>0</sup> for the rightmost pixel.

As each parameter is calculated it is stored in an array by line 730. Lines 770-790 read the values in the array and use them to redefine characters 224-232.

Lines 800-870 print the commands used to define the characters and display the characters thus defined immediately afterwards.

Lines 890-900 display the 3x3 block of characters at the bottom of the screen while line 910 calls a procedure that simulates the appearance of the block in 20 column modes.

Line 920 holds up the program until the SPACE bar is pressed.

PROCMODES extends the horizontal scale of each character by two to simulate its appearance in the 20 column modes.

PROCROTATE\_R reads the array of parameters and manipulates it to produce a display rotated to the right. Lines 1220-1230 determine the start point for each character, and 1240-1250 the start of each row (represented by one parameter) within the character.

Lines 1260-1280 convert the value of each parameter into a binary representation and sets the pixels in the grid to show this. Due to the rotation they will be set top to bottom instead of left to right.

PROC MIRROR and PROCROTATE\_L are similar to PROCROTATE\_R, but with slightly different manipulations of the parameters to give a mirror image and a rotation to the left respectively.

PROCCHOICE is a simple menu selection routine to allow the user to choose his next option and execute it.

**Listing starts on Page 112**



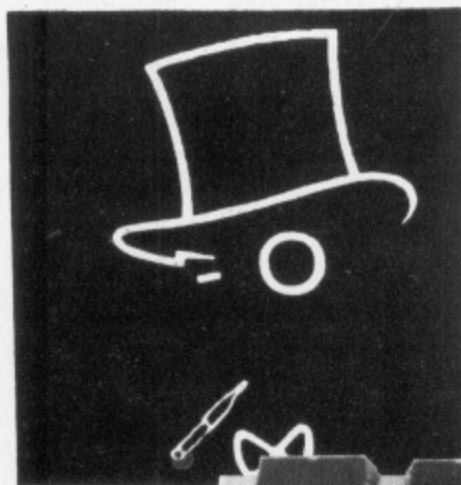

# SIR ROM EXPANSION BOARD

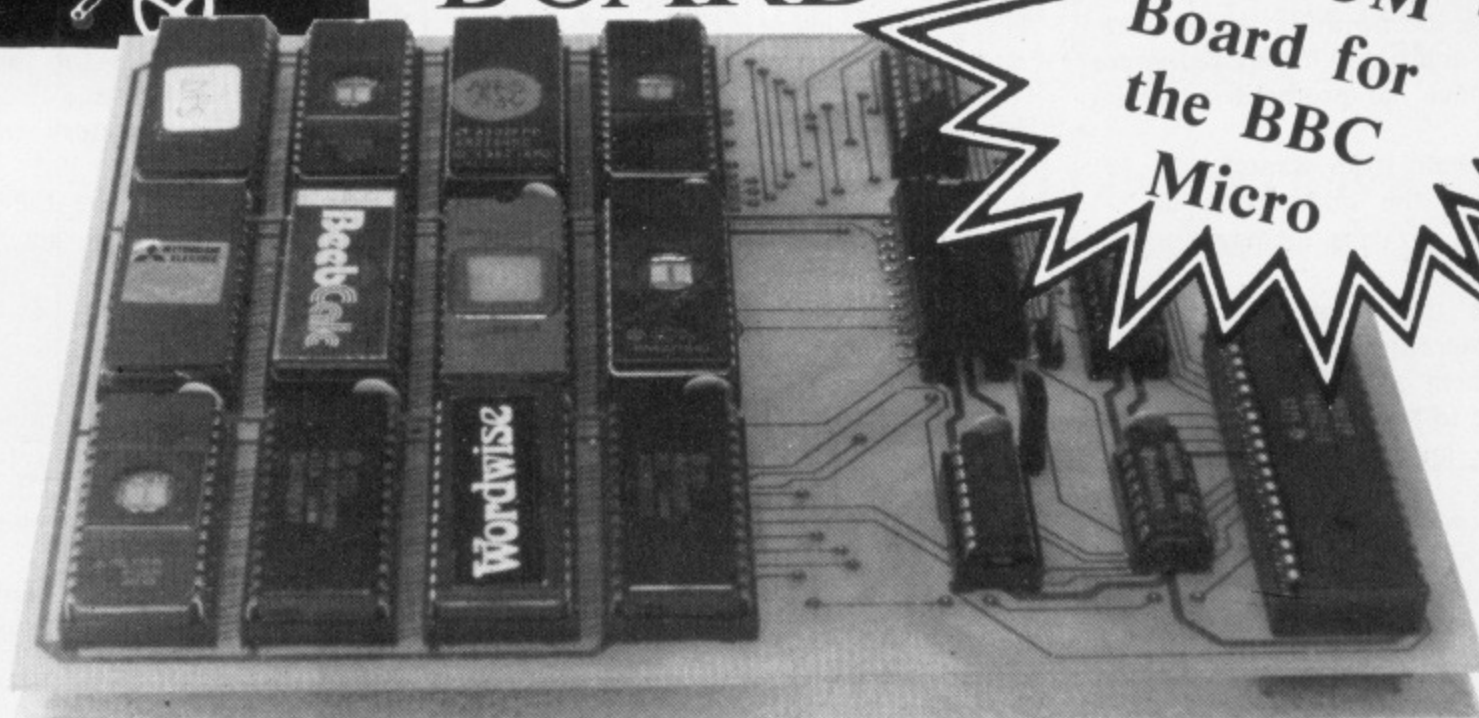

the ROM  
Board for  
the BBC  
Micro

## SIR ROM BOARD

THE ROM BOARD FOR THE BBC  
MICRO

- ★ Easy to install, no soldering, full instructions provided.
- ★ Allows up to 256K ROM space.
- ★ Fits easily inside BBC case.
- ★ Price **£40.25** (+ £1 p&p)

## ELECTRON

Acorn ELECTRON Computer £199.00  
The SIR Electron Peripherals range now available:

- ★ Printer/Joystick Port **£45.00** + VAT
- ★ 8-ROM Expansion Board **£40.00** + VAT

Please telephone for full details.  
**COMING SOON:** RS423 Interface, I/O port, and more!

### BBC MICROCOMPUTER

BBC Micro Model B ..... £399.00  
BBC Micro Model BD ..... £489.00

**SPECIAL OFFERS** (while stocks last)

PL Graphics Digitizer ..... £75.00  
Jupiter Ace Micro ..... £49.95

### SOFTWARE

Our range covers over 20 major software houses. Please write for details.

### COMPARE OUR PRICES!!

#### PRINTERS

Dot Matrix:  
Epson FX-80 ..... Only £399.00  
Epson RX-80 ..... £275.00  
Epson RX-80 F/T ..... £299.00  
Shinwa/CTI CP-80 ..... £263.35  
Daisywheel:  
Juki 6100 ..... £425.00

#### MONITORS

Sanyo Black/Green 12" ..... £85.00  
Microvitec Cub 14" Colour ..... £269.00

#### DISC DRIVES

Single 100K ..... £199.00  
Dual 100K ..... £349.00  
Dual 400K ..... £669.00

#### TORCH Z80 Disc Pack:

Z-80 2nd processor, 64K RAM, 2x400K drive and free word processor, database and spreadsheet software. NOW ALSO WITH 'COMANEX' business management game.

**NOW ONLY £839.50**

*ALL PRICES ARE INCLUSIVE OF VAT (unless stated otherwise)*

Address all enquiries to: **SIR COMPUTERS LTD. (DEPT. D12)**

**91 Whitchurch Road, Cardiff, CF4 3JP.**

**Telephone: (0222) 21341/621813**







A new age has dawned  
with the  
**STACK**  
**LIGHTPEN**

It's a new, easier way to creative software and it's fun too! The Stack Light Pen means freedom from the old labours of the keyboard and a new software style for the future.

Using the Light Pen means you can create programs, including games, with that extra dimension...control, at the touch of the pen. With your Light Pen you can remove words or images from the screen or put them back onto it, or simply move them about the screen. You can even trigger off a series of actions on screen, stopping them at will...with the touch of the Light Pen!

Already Available For **BBC** **ATARI** **VIC-20** **COMMODORE 64**

And it's so easy to use... simply hold it against the screen, touch the contacts and away you go!

**LIGHTPEN SOFTWARE**

We've already created software for you to use with your Stack Light Pen...

DRAUGHTS, GO, LIFE, CROSSWORD TWISTER, SIMON, OTHELLO, SEEK & DESTROY, SHUFFLER, LOST IN THE LABYRINTH and there's more on the way!!

**STACK LIGHT PENS and SOFTWARE are available from your LOCAL DEALER or direct from:**

STACK COMPUTER SERVICES LTD. 290-298 Derby Road, Bootle, Merseyside L20 8LN.  
(24 HRS) Telephone 051-933 5511, Telex 627026 (Stack G).

Please supply..... LIGHTPENS for the

**BBC**  **Atari**  **VIC-20**  **Commodore 64**

at £25.00 each £

and the following Software titles.....

at £5.00 each £

..... Add VAT at 15% £

**TOTAL £**

I enclose a cheque/PO for £

Please charge £..... to my credit card (specify card) .....

Card No. .... Name .....

Address .....

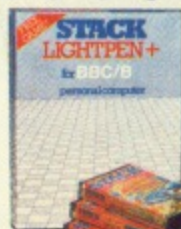

Access,  
Barclaycard Visa,  
American Express  
Diners.



# SOFTWARE FOR YOUR MICRO

## British Broadcasting Corporation



These new software packs are designed to exploit to the full the sophisticated design and great versatility of the British Broadcasting Corporation Microcomputer.

### White Knight: Mark Eleven

The amazing chess program that won joint first place in the P.C.W. Microcomputer Chess Championships.  
£11.50

### Canyon

'The game is fascinating, the graphics are good, the instructions excellent, and the whole thing is a pleasure'  
- THE MICRO USER  
£10.00

### Dr Who: The First Adventure

Wriggling Worms and Terrordactyls are among the hazards facing Dr Who in this exciting graphics game.  
£10.00

### VU Type

An ingenious program that teaches you to touch-type without the need for a book, using exercises approved by Pitmans.  
£16.10

### Record Keeper

A very useful program enabling householders and small businessmen to keep track of their lists.  
£13.80

### Taxcalc

This Which? income tax calculator enables you to check your tax bill for 1982-83.  
£17.25

### Toolbox

This invaluable set of programming aids includes a REM stripper, cruncher, RAM test and program re-sequencer.  
£21.00

### Beyond Basic

A book and software pack explaining and demonstrating assembly language programming using the British Broadcasting Corporation Micro's built-in BASIC assembler.

Book £7.25 Software Pack £11.50

Published jointly with National Extension College Trust Ltd.

### The Friendly Computer Book

An illustrated, step-by-step guide to computing and BASIC, by Jonathan Inglis.  
£4.50

The original software range from the British Broadcasting Corporation is still available:

Early Learning. Fun Games. Games of Strategy. Home Finance. Painting. Drawing. Music. The Computer Programme Programs Vol. 1 The Computer Programme Programs Vol. 2 Each £10.00

ON SALE NOW AT  
SELECTED BOOKSELLERS AND  
MICROCOMPUTER SHOPS

Prices include VAT.



**SPECIAL  
OFFER FROM  
THE MICRO USER**

# The Advanced User Guide

**The essential companion  
for the BBC Micro.**

Featured in its 512  
information packed pages  
are

- ★ *the BASIC Assembler*
- ★ *6502 machine code  
reference section*
- ★ *complete descriptions of  
all FX calls*
- ★ *BBC memory usage and  
vectors explained*
- ★ *full interfacing details for  
the user port, tube,  
analogue port, 1 MHz bus*
- ★ *paged ROMs explained*
- ★ *and lots, lots more*

With many examples to  
illustrate the text, this guide  
is the indispensable  
reference work for the  
serious BBC micro  
programmer.

## THE ADVANCED USER GUIDE FOR THE BBC MICRO

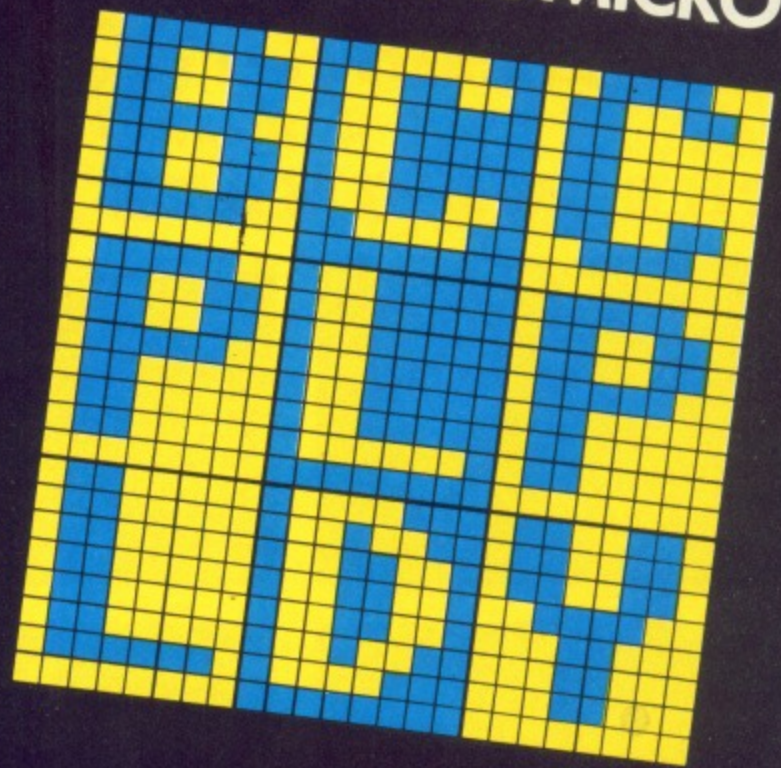

**BRAY, DICKENS & HOLMES**

**ONLY  
£12.95**  
(plus p&p)

### ORDER BY POST TODAY!

Please send me ..... copies of The Advanced User Guide  
at £13.95 (inc. p&p) TOTAL £ .....

Name .....

Address .....

.....

.....

.....

Signed .....

Please indicate method of payment (✓)

Cheque/PO made payable to  
Database Publications Ltd.

Access/Mastercharge/Eurocard

Barclaycard/Visa

American Express

Card No.

Expiry date

Send to: Micro User, FREEPOST,  
Europa House, 68 Chester Road,  
Hazel Grove, Stockport SK7 5NY.  
(No stamp needed if posted in UK).

Or you can order by phone quoting  
credit card number and expiry date.

**061-456 4157**



**ORLANDO'S BACK!**

# ZALAGA

**Aardvark Software, creators of the Ultimate Atom Games, bring you NOW**

**THE ULTIMATE BBC SPACE-GAME**

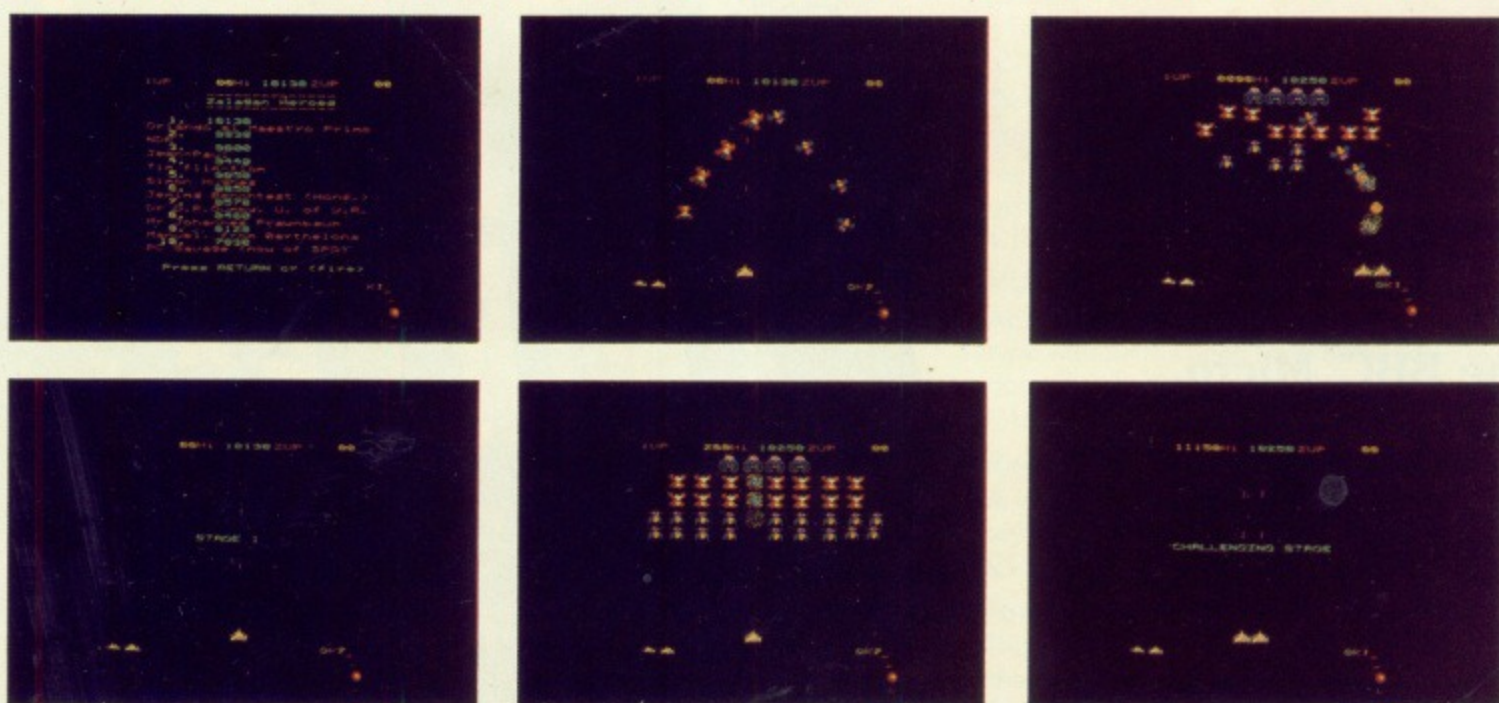

Seated at your computer, streams of multi-coloured aliens swirl past your laser-base into formation. The first squadron appears harmless, but later waves will avenge the deaths of their comrades with increasing ferocity. To combat the swooping bomb dropping meanies, you may try to link up a pair of laser-bases and **double your fire power!** Your progress through successive phases will be rewarded by challenge stages, where large bonuses may be earned. The game builds up to a dizzying crescendo of high speed motion where instant reflexes and pure technique are your only hope of survival. . .

One or two player game • Keyboard or joystick • Sound on or off • Escape facility  
• Works on all OS's and Tubes • Ten name Hi-score table • Mode 2 full colour graphics • Continuous rolling twinkling stars • Multiple missiles • Full screen action • Attractively packaged in a collectable library case • High quality cassette • Full instructions • For BBC model B or A + 32K •

Send cheques/P.O.s for £6.90 to

**Aardvark Software,  
100 Ardleigh Green Road,  
HORNCHURCH, Essex.**

**FRAK coming soon . . .**



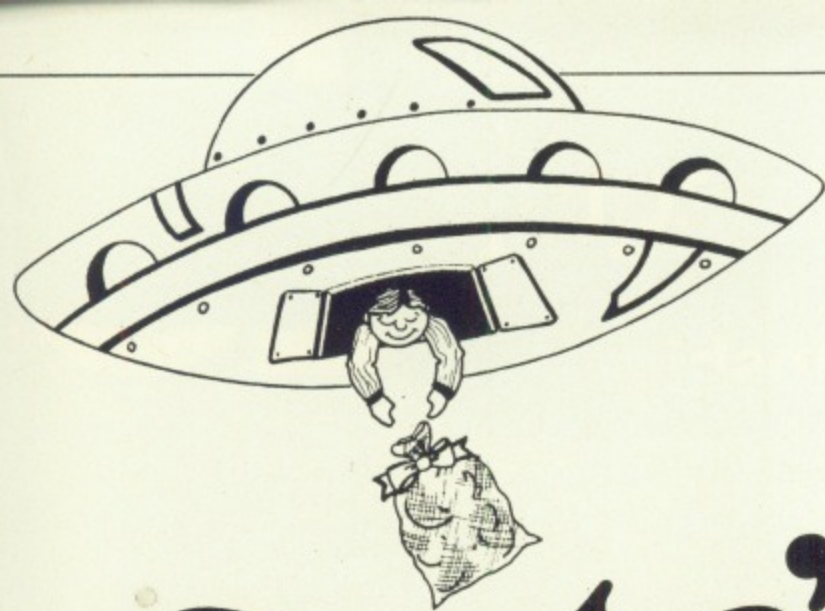

# Santa's Saucer

## List of procedures

**PROCSMO** checks to see which keys are being pressed and moves Santa's ship accordingly.

**PROCPRDR** is called whenever a present is dropped, and sets up the variables for the present.

**PROCPRMO** moves the present downwards and checks to see if it hits anything.

**PROCINIT** sets up the variables at the start of each new sheet.

**PROCMISET** is called whenever a missile is fired by the AA gun, and initialises the variables used by the missile.

**PROCDELAY (X)** causes a delay of X centiseconds.

**PROCHOUSE (X, Y)** draws a house at X, Y.

**PROCSCREEN** initialises the screen.

**PROCTM** moves the turret of the AA gun.

**PROCMI** moves the missile fired by the gun and checks to see if it hits anything.

**PROCSCORE (X)** adds X points to the score and displays the new score.

**PROCPREZ** decreases the number of presents the player has and displays this number.

**PROCWINDOW (X)** draws a man in the window of the house specified.

**PROCDEL** calculates and displays the percentage of presents delivered

safely.

**PROCPRNO (X)** displays information about the number of presents to be delivered to the house specified.

**PROCINSTRUCTIONS** no prizes for guessing!

**PROCTUNE (X)** plays tune X. O=Jingle Bells, 1=Congratulations.

*The main program variables are:*

**HO%(4)** data concerning the houses.

**HI%(4,1), HIS(4)** high score variables.

**SC%** score.

**DEL%** number of successful deliveries.

**TP%** total number of presents dropped.

**BAPRES%, PRES%** number of presents the player has.

**MILOC%** determines the accuracy of the missiles fired by the AA gun.

**X%, Y%** co-ordinates of Santa's ship.

**PR%** flag determining state of present.

**PRX%, PRY%** present's co-ordinates.

**PRDES%** total number of presents to be delivered.

**MIA%** flag determining whether the plane or the missile is to be moved.

**N%, M%** general loop variables.

**I%, X, Y** used to pass parameters in procedures.

**MI%, MI2%, MI3%, MI4%, MIS%, MIS2%** used to position and move missile.

**RP%, RP2%** plane co-ordinates.

**V%, V1%** sound volume variables.

SANTA has found that he cannot make all his Christmas Eve deliveries using the traditional reindeer and sledge — the world's population is just too large these days.

So he has hired a flying saucer to speed up the process.

Unfortunately the reindeer did not like being made redundant and they formed an action group. Now reindeer have a foul temper so they will stop at nothing to prevent Santa from delivering his presents.

Santa will be busy making up the presents, so he needs someone to fly the ship and drop them into chimneys. You are the one to complete this task! The world is depending on you. There are about 200,000 million houses to deliver to, so you will get plenty of practice.

The number of presents to be delivered to each house is shown on the screen, and you must drop them down its chimney. You only have a limited number of presents for each city — if you run out of presents you will be sacked.

Santa cannot bear inefficiency (see what happened to the reindeer) so you must deliver at least 60 per cent of the presents safely.

Presents are lost if you drop them on the roof of a house or on a plane, or if they are shot by the reindeer. The reindeer have an AA gun and a plane to attack you with, and their shooting becomes more accurate as the game progresses.

Instructions concerning movement are given in the program.

**Listing starts  
on Page 136**





# Electronequip

in  
Hampshire

Authorised BBC Dealer's Service Centre

Reference	Description (Accessories)	ExcVAT	IncVAT
BKADVANC	Advanced User Guide for the BB Micro	13.25	13.25
BKALPBBC	Assembly Language Prog for the BBC (593)	8.50	8.50
CNBPOWER	Plug for BBC Power Outlet (1-480424-0)	0.95	1.09
CNDISCPD	Power socket for Disc Drive (1-350234-9)	0.95	1.09
ACBCASEH	Hard carrying case for BBC	45.44	52.25
ACBCASES	Soft carrying case for BBC	19.00	21.85
ACBCOV1	Dust Cover for BBC (Cloth)	2.85	3.28
ACBCOV2	Dust Cover for BBC (Plastic)	4.09	4.70
ACBGPAD	Graphics Pad for BBC	71.25	81.94
ACBJOY1	Beebstick Joystick (HIGH RES)	24.70	28.41
ACBJOY2	BBC Joysticks (pair) (ANH01)	10.74	12.35
ACBPLS01	Plinth & Storage for BBC	24.70	28.41
ACBPROG	Eprom Programmer (ATPL) (25/2716-27128)	120.00	138.00
ACBSOUNL	Sound Pick off lead for BBC Micro	6.60	7.59
ACBSPEAK	Loudspeaker in veneer case for BBC	12.83	14.75
ACBU	Plinth (U) for BBC	16.43	18.90
ACERASER	Eraser for Eprom's with timer	56.05	64.46

SIDWISE

SIDWISE FITTED

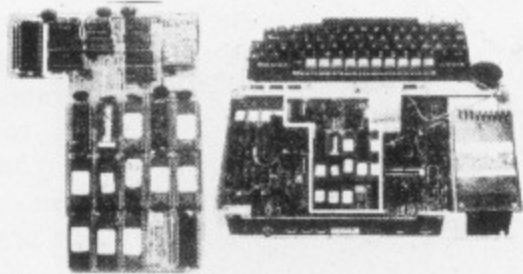

Reference	Description (BBC Micros)	ExcVAT	IncVAT
ANA01	BBC Model A Micro Computer	261.30	299.00
ANA02	BBC Model A with Econet Interface	310.86	356.00
ANA32	BBC Model A Micro with 32K	291.30	333.50
ANA33	BBC Model A Micro with 32K and VIA	296.52	339.50
ANB01	BBC Model B Micro Computer	348.26	399.00
ANB02	BBC Model B with Econet Interface	389.14	446.00
ANB03	BBC Model B with Disc Interface	409.14	469.00
ANB04	BBC Model B with Disc & Econet Interface	450.01	516.00
SYBWP1	BBC Wordprocessor View Disc Daisy Print	1092.50	1256.38

Reference	Description (BBC Micros)	ExcVAT	IncVAT
UGATOB	BBC Model A to Model B Upgrade (ANA11)	66.50	76.48
UGDISC	Disc Upgrade for BBC B (ANB13)	76.00	87.40
UGECONET	Econet Upgrade for BBC (ANB12)	66.50	76.48
UGSERIAL	Special Port Upgrade for BBC (RS 423)	9.50	10.93
UGSPEECH	Speech Upgrade for BBC (ANB14)	45.44	52.25

Reference	Description (BBC Micros)	ExcVAT	IncVAT
SP1_2ROM	1.2 Operating System Rom	6.00	6.90
SP6522	6522 VIA Chip for BBC	5.22	6.00
SP8271	8271 Disc controller chip for BBC	40.00	46.00
SP2764	2764 300nS Eprom suitable for BBC	4.75	5.46

## ROMs

Reference	Description (BBC Micros)	ExcVAT	IncVAT
BRASVIEW	View word processing package (SBB03)	49.40	56.81
BRCCBEC	Beebcalc rom (spread sheet) (Com. Con.)	32.30	37.14
BRCCDISC	Computer Concepts Disc Doctor rom	26.60	30.59
BRCCTERM	Computer Concepts Termi rom (Terminal)	26.60	30.59
BRCCWORW	Wordwise Word processing ROM	33.54	38.57

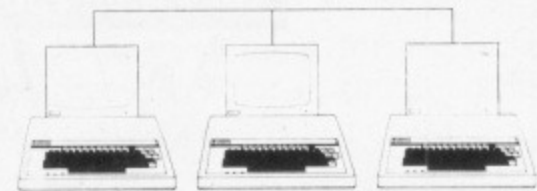

Reference	Description (BBC Micros)	ExcVAT	IncVAT
Econet	Econet System Clock (Acorn) (AEH14)	37.17	42.75
ECALOCK	Econet 10 Station lead set (Acorn) AEH18	23.96	27.55
ECALADS	Econet Terminator (Acorn) (AEH15)	28.91	33.24
ECATERM	Econet cable 1M	0.82	0.94
ECCABLE1	Econet File server level 1 (AES20)	81.79	94.05
ECFILES1	Econet File server level 2 (AES21)	205.69	236.55
ECPRINTR	Print server Rom (AES22)	40.48	46.55
ECSCLOC	Econet Clock & Terminators (SJ)	71.25	81.94

Large Stocks. Vast range of Software (not just games). BBC A&B in stock.  
All printers and Disc drives are supplied with all connecting cables, formatting discs, cases, documentation etc.

## SPECIAL OFFERS

PHONE FOR DETAILS



Electronequip is an authorised Acorn service centre and has been an Acorn dealer since the introduction of the Atom.

Our demonstration facilities include 20 station Econet and Trochnet systems

SIDWAYS ROM BOARD FOR BBC (no soldering) only 38.00 + vat

Reference	Description (BBC Micros)	ExcVAT	IncVAT
DDAND01	BBC 100K Single Disc Drive (AND01)	218.91	251.74
DDAND02	BBC 800K Dual Disc Drive (AND02)	664.05	763.66
DDT1000A	Teac 100K Single 40T Disc Drive for BBC	174.80	201.02
DDT2000A	Teac 200K Dual 40T Disc Drive for BBC	344.85	396.58
DDT2000E	Teac 200K Single 80T Disc Drive for BBC	222.30	255.65
DDT4000E	Teac 400K Dual 80T Disc Drive for BBC	439.85	506.83
DDT4000F	Teac 400K Single 80T Disc Drive for BBC	288.80	332.12
DDT8000F	Teac 800K Dual 80T Disc Drive for BBC	572.85	658.78
DSD40S	5 25" Datafile 40T Single-sided disc	1.90	2.19
DSM800	5 25" Memorex 80T Double-sided disc	2.47	2.94

**TORCH**  
COMPUTERS  
Perfectly Made in Britain

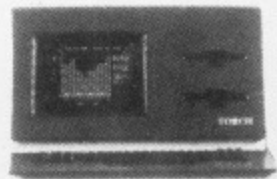

Reference	Description (BBC Micros)	ExcVAT	IncVAT
DDT2800P	Torch Z80 Disc Pack (800K Dual - Z80)	695.00	799.25
CF240	Torch Computer twin floppies (CF240)	2655.25	3053.45
CF240/10	Torch Computer 10Mb Winchester CF240/10	4745.25	5457.04
CF240/21	Torch Computer 21Mb Winchester CF240/21	5220.25	6003.29
TZ80P	Torch Z80 Second Processor for BBC	250.00	287.50
TCBBCBAS	Torch CPN BBC Basic (Z80)	104.50	120.18
TCMULTIP	Torch CNP Multiplan (Spread sheet)	179.55	206.48
TCPEPERSQ	Torch CPN Perfect Software Set	285.00	327.75
TCPLANC	Torch CPN Planericaic (spreadsheet)	80.75	92.86
TCPPFORT	Torch CPN Prospero Fortran	209.00	240.35
TCPPPASC	Torch CPN Prospero Pascal V2.1	209.00	240.35
TCWORDST	Torch CPN Wordstar Wordprocessing	261.25	300.44

Access & Barclay card welcome (Large discounts for educational orders)

Trade enquiries welcome.

Carriage 0.50 to 3.50

Reference	Description (Cassette Recorders)	ExcVAT	IncVAT
CAC10	C10 Data Cassette tape	0.46	0.52
CAC15	C15 Data Cassette tape	0.49	0.57
CACS	C5 Data Cassette tape	0.41	0.48
CACASE	Cassette Case (only)	0.10	0.11
CRANF03	BBC Data (cassette) Recorder (ANF03)	26.00	29.90
CRDATEX	Datex Computer Cassette Recorder (DX-3)	24.70	28.41
CRSDR	Data Recorder (Sanyo DR101)	34.74	39.95



Wordprocessing system on BBC Micro with Daisy Wheel Printer and disc drive. Cost 1092.50 + VAT ref. SYBWP1

Reference	Description (Cassette Recorders)	ExcVAT	IncVAT
DDAND01	BBC 100K Single Disc Drive (AND01)	218.91	251.74
DDAND02	BBC 800K Dual Disc Drive (AND02)	664.05	763.66
DDT1000A	Teac 100K Single 40T Disc Drive for BBC	174.80	201.02
DDT2000A	Teac 200K Dual 40T Disc Drive for BBC	344.85	396.58
DDT2000E	Teac 200K Single 80T Disc Drive for BBC	222.30	255.65
DDT4000E	Teac 400K Dual 80T Disc Drive for BBC	439.85	506.83
DDT4000F	Teac 400K Single 80T Disc Drive for BBC	288.80	332.12
DDT8000F	Teac 800K Dual 80T Disc Drive for BBC	572.85	658.78
DSD40S	5 25" Datafile 40T Single-sided disc	1.90	2.19
DSM800	5 25" Memorex 80T Double-sided disc	2.47	2.94



Reference	Description (Cassette Recorders)	ExcVAT	IncVAT
MNK12A	Kaga K12A 12" Orange Monitor	107.35	123.45
MNK12B	Kaga 12" 09 Black White Monitor	94.05	108.16
MNK12G	Kaga K12G 12" Green Monitor	94.05	108.16
MNKVIS2	Kaga 12" RGB Monitor Vision II (Medium)	270.75	311.36
MNKVIS3	Kaga 12" RGB Monitor Vision III (Hi)	379.05	435.91
MNM1431	BBC 14" Colour Monitor (Microvitec 1431)	215.00	247.25
MNM1441	Microvitec 1441 High Res 14" BBC Monitor	474.05	545.16
MNM1451	Microvitec 1451 Medium Res 14"	355.30	408.80
MNN 1434	14" TV Monitor Nordmende	214.70	246.90
MNN3434	14" TV Monitor Normende with remote cont	224.10	257.72
MNSM12N	Snayo SM12N Green Monitor 15MHz	75.05	86.31

## EPSON RX-80 & FX-80

Reference	Description (Cassette Recorders)	ExcVAT	IncVAT
PAETRACT	Tractor unit for Epson FX-80	34.20	39.33
PPFF1K	1000 Sheets fan-fold tractor feed paper	6.19	7.12
PPROLLTR	Roll paper for Sparkjet Epson (TR-1)	1.70	1.96
PRCP80	Fim Ribbon for CP-80 printer	4.75	5.46
PRE80	Ribbon for Epson MX-FX RX 80	5.70	6.55
PRJP101	Inkjets for JP101 (pack of 4)	5.70	6.55
PRMX100R	Ribbon refill for Epson MX-FX 100	4.37	5.03
PRTP1200	Fabric Ribbon for Smiths Corona TP-1	2.85	3.28
PRTP1220	Fim Ribbon for Smiths Corona TP-1	2.85	3.28
PTCP80	CP-80 80cps Printer (MX-80 type III)	284.05	326.66
PTFX80	Epson FX80 160cps Printer	365.09	419.85
PTFX100	Epson FX100 160cps Printer	493.05	567.01
PTJ6100	Junki 6100 Daisy Wheel Printer 18cps	365.09	419.85
PTJP101	BBC Spark-Jet Printer	284.05	326.66
PTMX100	Epson MX?? Type 3 Printer	422.75	486.16
PTMX80	Epson MX-80 80cps Dot matrix printer	350.55	403.13
PTRX80	Epson RX-80 Printer 100cps	257.00	295.55
PTRX80FT	Epson RX-80FT Printer 100cps (T-Fric)	280.25	322.29
PTT1040	TEC F10-40 40cps Daisy Wheel Printer	1220.75	1403.86
PTTCLOR	Torch Colour Printer	1472.50	1693.38

Kings Lynn Branch  
Tel: 0553 3782



# Electronequip



36-38 West Street, Fareham, Hants

(0329) 230670



## A QUALITY LIGHT PEN for the BBC Micro

- ★ Absolutely insensitive to ambient lighting.
- ★ Responds to different colours and screen intensities without any adjustment of TV or monitor.
- ★ Red LED readout showing that data is available.

- ★ Switch for program control (allows pen to approach the screen without erroneous data capture)

- ★ All features are program accessible



Free Software includes

- ★ Handbook
- ★ Good Documentation
- ★ Tape storage of your work
- ★ User routines provided on tape and printout
- ★ 'Freehand' drawing program
- ★ 'Library menu' drawing program (define your own library of shapes)
- ★ Example programs illustrating uses of the pen and its features

£25

inclusive

Also available for VIC-20 and DRAGON microcomputers please state your computer type when ordering.

Send cheque or P.O. for £25 to:

Dept. MU1, Datapen Microtechnology Ltd., Kingsclere Road, Overton, Hants.

Please enclose SAE if requesting literature

Now also available from good dealers.

**Datapen Microtechnology Limited**

## MICROBYTE SOFTWARE

### 3D Space Ranger



For  
BBC  
32K

**£7.95**

- SUPERB 3D GRAPHICS.
- FIVE DIFFERENT LEVELS OF PLAY.
- ALL MACHINE CODE GAME.
- BATTLE THROUGH SPACE ATTACKS.
- AVOID HURLING ASTEROID BELTS.
- SKIM OVER THE DEATH STAR SURFACE.
- DESCEND INTO THE TRENCH.
- BATTLE WITH ATTACKING ANDROIDS.
- YOUR MISSION - DESTROY THE DEATH STAR ... AND THEN ESCAPE!



### PINBALL

THE ORIGINAL ARCADE GAME  
SUPERB GRAPHICS & SOUND

ELECTRON/BBC 32K

### REVERSI

AN ANCIENT GAME OF SKILL.  
DIFFICULT TO MASTER  
HOURS OF ABSORBING FUN.



ELECTRON/BBC 32K

ALL PRICES FULLY INCLUSIVE OF POST & PACKING



Orders to:  
MICROBYTE SOFTWARE (M1)  
**FREEPOST**  
NEWQUAY TR7 2BR.  
NO STAMP NEEDED IF POSTED IN U.K.

## TWO WAYS TO ENSURE YOU GET

# THE MICRO USER

### EVERY MONTH

1. Complete and mail subscription form on Page 99
2. Hand this form to your newsagent.

Please reserve me a copy of The Micro User magazine every month until further notice.

- I will collect  
 I would like it delivered to my home.

Name \_\_\_\_\_

Address \_\_\_\_\_

*Note to newsagent: The Micro User should be obtainable from your local wholesaler, or contact the distributor - Wells, Gardner, Darton & Co Ltd Tel: Faygate 444*

ck  
H. SMITH

OFESSOR £8  
ME You're only an  
going to survive in the  
onstrous spiders, ants  
The crystals do it.

AND EIGHTY  
ER DARTS  
n and enjoy the  
ai and other games  
n opponent.

ADE GAME\*  
eed are needed to  
attack.

ER BOOK SHOPS  
(Y)

ON ATTACK

ware

re OL16 5LB.



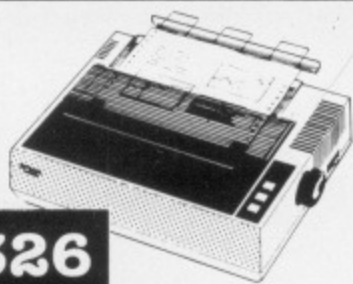

## Epson Fx 80 Printer

**£326**

Including lead for BBC.  
Send £375  
to include VAT, p&p.

## 200K Disk Drive

40 Track  
Single & Double

62 file names  
including cable and power lead.  
Send £175 to include VAT, p&p,  
inc. formatting disk & manual.  
800K & 800K switchable with  
power supply available - ask for details.

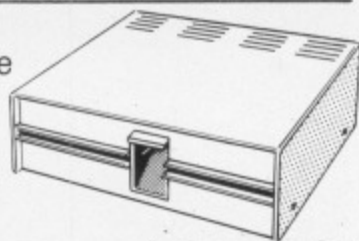

**£152**

## 400K Disk Drive

80 Track  
Single & Double

124 file names  
including all necessary leads.  
Send £299 to include VAT, p&p,  
inc. formatting disk & manual.

Send  
for a full list  
of all our  
drives!



**£259**

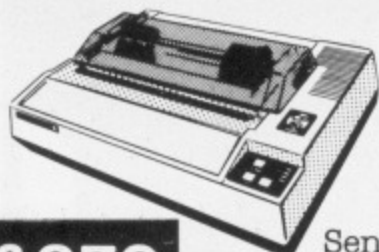

## Star DP510 or Shinwa CP80

Matrix printers including  
BBC lead and power leads.  
Send £275 to include VAT, p&p.

**£239**

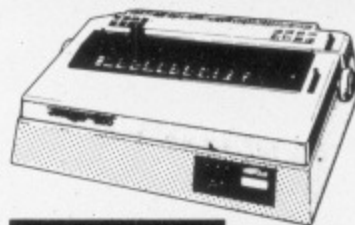

## Juki Daisywheel Printer

**£338**

18 CPS including cable.  
Send £389 to include VAT, p&p.

## Sanyo/BMC Monitors



12" amber or green screens.  
Send £99 to include VAT, p&p.

**£86**

## MCP 40 Printer/ Plotter

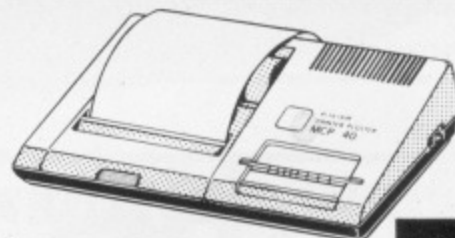

Complete, including case.  
Send £145 to include VAT, p&p.

**£126**

## Diskettes

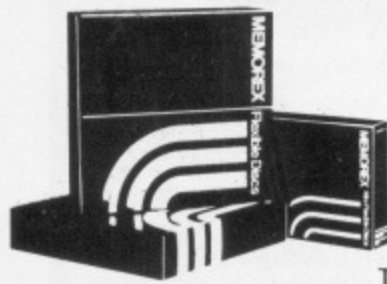

Memorex, in packs of 10  
SS 40tk ..... £16.00  
DS 40tk ..... £20.00  
SS 80tk ..... £26.00  
DS 80tk ..... £29.00

Including VAT, p&p.



Disk storage boxes .....  
£15.00 (takes 35)  
Disk storage boxes .....  
£20.00 (takes 80)  
Prices include VAT, p&p.

## Accessories

BBC Stands ..... £10.00  
Dust covers ..... £4.95  
(for BBC,  
Drives and  
Printers)

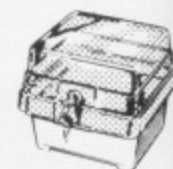

Product	Price to members	Qty.	Total
200K DISK DRIVE	<input type="checkbox"/> £175.00	_____	£ _____
400K DISK DRIVE	<input type="checkbox"/> £299.00	_____	£ _____
EPSON FX80	<input type="checkbox"/> £375.00	_____	£ _____
STAR DP510	<input type="checkbox"/> £275.00	_____	£ _____
SHINWA CP80	<input type="checkbox"/> £275.00	_____	£ _____
JUKI PRINTER	<input type="checkbox"/> £389.00	_____	£ _____
SANYO/BMC-AMBER	<input type="checkbox"/> £99.00	_____	£ _____
SANYO/BMC-GREEN	<input type="checkbox"/> £99.00	_____	£ _____
MCP 40	<input type="checkbox"/> £145.00	_____	£ _____
SS 40 DISKETTES	<input type="checkbox"/> £16.00	_____	£ _____
DS 40 DISKETTES	<input type="checkbox"/> £20.00	_____	£ _____
SS 80 DISKETTES	<input type="checkbox"/> £26.00	_____	£ _____
DS 80 DISKETTES	<input type="checkbox"/> £29.00	_____	£ _____
BBC STAND	<input type="checkbox"/> £10.00	_____	£ _____
DUST COVERS	<input type="checkbox"/> £4.95	_____	£ _____
DISK STORAGE (35)	<input type="checkbox"/> £15.00	_____	£ _____
DISK STORAGE (80)	<input type="checkbox"/> £20.00	_____	£ _____

MEMBERSHIP APPLICATION FEE  £10.00  
TOTAL SUM ENCLOSED (Cheque or credit card no.) £ \_\_\_\_\_

To: The BBC DC, 46 Princes Avenue, Finchley, London N3.

I enclose my order for the above products at discount as a member of the BBC DC. I understand I will receive mailings of new products and special offers as they become available.

Name \_\_\_\_\_

Address \_\_\_\_\_

Signed \_\_\_\_\_

I would like you to return my money if the goods ordered are not despatched within two weeks of receipt of order.

ALL PRODUCTS ARE BRAND NEW, BOXED AND OFFERED WITH FULL MANUFACTURERS WARRANTY. ALL QUERIES WILL BE ANSWERED BY MAIL.

# BBC % DC



Write your own 'Arcade Action' games without machine code.

# YOURS TO CREATE AND COMMAND

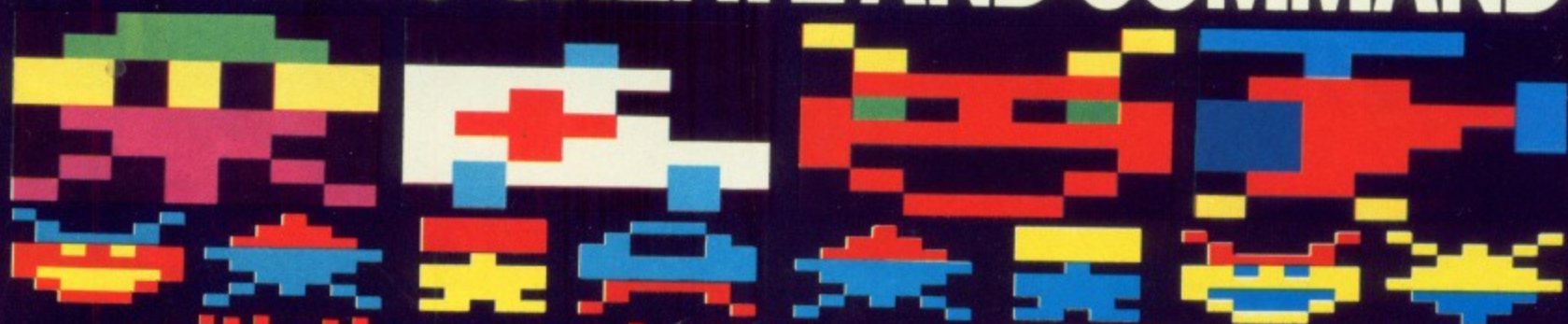

with the revolutionary **SPRITE-GEN**  
for the BBC microcomputer

**SPRITE-GEN** is an amazing and revolutionary piece of software. You can create multi-coloured fast-moving sprites quickly and easily without machine code. Until now, only experienced machine-code programmers could produce 'Ghost Gobbling Monsters' and 'Light Speed spacecraft'. With **SPRITE GRAPHICS** any character or object you imagine are at your command, moving smoothly at any speed in any direction. Supplied on cassette it can be used on disk.

**Look at these features:**

- \* Up to 32 SPRITES on screen at any time.
- \* Limitless SPRITE design using the SPRITE Generator program included in the package, allows ALL SIXTEEN logical colours "In each SPRITE" if desired. Full operating system capable of logical/actual colour assignment.
- \* There can be up to EIGHT different SPRITE DESIGNS active at one time, each of which can have up to THREE "CLONES" (copies of the primary SPRITE but each with individual movement control).

\* Each SPRITE actually has TWO images which given slight differences will achieve the animation effects when the two are alternated. Or, if you choose, give the two images totally different designs and you have created two SPRITES out of one, usable alternately. This technique can also be applied to the CLONES which means that all 32 SPRITES can be animated, multi-coloured, moving objects!!!

\* Once you have completed the design of your SPRITES using the simple grid-based generator utility, they and the high speed machine-code routines that control their movement are secreted into RAM and the BASIC system is ready to accept your own program lines through which you can direct the SPRITES to appear, move, disappear or just remain stationary.

\* SPRITES can be linked together in pairs or groups to produce large scale animation. Of course, if you wish they can be as small as a single pixel.

\* Your own creations can move in front of each other with no loss of detail.

With **SPRITE-GEN** you can use your imagination and micro to the full for fun and profit. Ideal for Schools and Colleges. Comes complete with two brand new sample games and fully illustrated instruction manual at just **£17.95** (U.S. \$49.95)

## SUPER - 7

The best value in arcade-type games available today. Seven exciting machine-code games in full colour and sound. Space Pilot Test, Guns of Navarone, Creatures of the Deep (COD), Fire Chief, Space Rescue, Chopper Chase, Bouncer. (BBC B Only) **Only £8.95.**

## 747 FLIGHT SIMULATOR

### Now Electron!

BBC \* Dragon \* TRS 80 C/C \* Electron

Exactly reproduces the flight deck of a 747, 21 real dials and 25 other indicators. You select passenger level, fuel loads and flight plan. Random emergencies make this one of the most exciting and taxing programs even written.

Your controls operate throttle, ailerons, elevators, flaps, slats, spoilers, landing gear, reverse thrust, brakes etc. Runway shown in true perspective to position, indicators show distance and bearing: Operates with two joysticks and keyboard.

"A real simulation, not just another game" (Your Computer, April '83)  
**Cassette £9.95 inc VAT (US \$27.95)**



ACTUAL SCREEN PHOTOGRAPH

To DACC Limited, 23 Waverley Road,  
Hindley, Nr. Wigan, Lancashire WN2 3BN. BBM/12

Please rush me:

\_\_\_\_\_ qty. SPRITE-GEN at £17.95 each

\_\_\_\_\_ qty. FLIGHT SIMULATORS at £9.95 each

\_\_\_\_\_ qty. SUPER 7 at £8.95 each

Please state machine.

I enclose a cheque/PO to the value of £ \_\_\_\_\_

Name \_\_\_\_\_

Address \_\_\_\_\_

Postcode \_\_\_\_\_

DACC Limited,  
23, Waverley Road,  
Hindley, Nr. Wigan,  
Lancashire WN2 3BN.



In US order from sole distributor:  
Frank Ashton, PO Box 7037,  
Chula Vista, CA 92012-7037.  
(California residents add 6%)



# EXPERIENCE THE VORTEX!

## the invasion continues

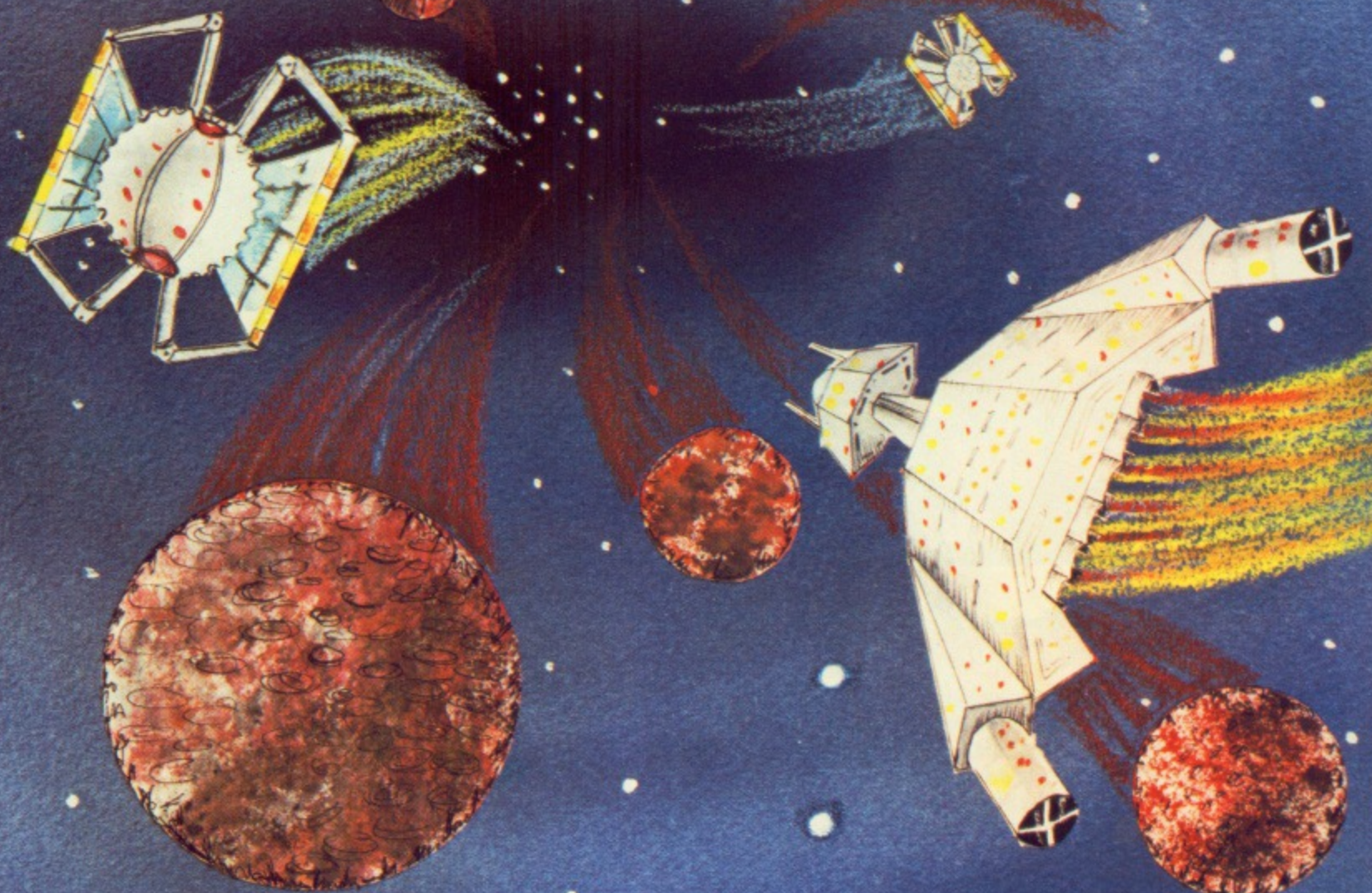

We continue the invasion this month with our latest and most exciting release yet. Have you the courage to enter the VORTEX? - You'll need all your senses and co-ordination tuned to perfection to avoid being fragmented by asteroid storms or vaporized by aliens. Each second you remain intact, your velocity will continue to increase as the vortex draws both you and all the surrounding debris into its clutches. The point is inevitably reached where even your super human reactions are too slow to avoid collisions with asteroids, and your ship is destroyed with a blinding flash and a cascade of radioactive particles. This is definitely our best game yet, from the author who created Gunsmoke, 3D Bomb Alley and Attack on Alpha Centauri. VORTEX uses keyboard or joysticks, with the option of sound effects and a pause control. (Seat belts recommended but not included!) The true three dimensional illusion will captivate your senses, as you come face to face with the VORTEX. A 3D space voyage for the BBC micro model B for just £7.95 on cassette or £11.95 on disc.

Other programs available for the BBC Micro Model B:- Cassette £7.95 inc. Disc £11.95 inc.

### GUNSMOKE



"... the graphics are excellent and the whole thing well designed."  
 "... a game for the family - simple, but enjoyable"

THE MICRO USER

### 3D BOMB ALLEY



"This is a very addictive game and is good value for money"

BEEBUG

### ATTACK ON ALPHA CENTAURI

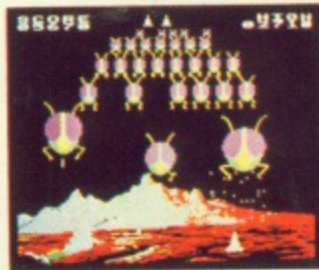

"The game features some of the best and most unusual graphics yet for the BBC micro"

BEEBUG



Send a S.A.E. for details or ask your local dealer for a demonstration.  
 Our software is available from more than 500 retail outlets in the UK, including W.H. Smith, HMV, all Spectrum Group shops and most good dealers.

We also offer a rapid mail-order service by writing to:  
 Software Invasion, 50 Elborough St., Southfields, London SW18 5DN.

See us at the  
**BBC MICRO USER SHOW**  
 Westminster Exhibition  
 Centre, London  
**DECEMBER 8-11**



The *Micro User* and *Electron User* wish you all a Happy Christmas with our musical Christmas card program which comes courtesy of 14-year-old Linda Stonebanks.

Type it in before your Christmas pudding or you might not be up to it!

**Let  
Santa  
Linda  
deliver**



**your Christmas cards**

```

10 REM *****
   *****
20 REM *** A CHRISTMAS
   CARD ***
30 REM *** by Linda Stoneb
   anks ***
40 REM *** C The Micro
   User ***
50 REM *****
   *****
60 *KEYOMODE0!MVDU14!ML.IM
80 VDU 23;11,0;0;0;0;
   :REM DELETE CURSOR
90 VDU 23,224,24,24,24
   ,24,24,24,24,24
100 VDU 23,225,8,28,62
   ,62,62,62,28,8
110 VDU 23,226,0,0,0,24
   ,24,0,0,0
120 VDU 23,227,0,24,36
   ,66,66,36,24,0
130 VDU 23,228,&66,&81
   ,&81,0,0,&81,&81,&66
140 ON ERROR VDU 14
   :VDU 20
   :REPORT
   :PRINT " at line ";
   ERL ,
   :STOP
150 ENVELOPE 1,6,0,0,0
   ,3,16,16,125,-5,-15
   , -15,126,60
160 MODE 2
   :octave$="cCdDefFq6aAb"
   :REM CAPS=# (C=c sharp)
170 FOR hsize=5 TO 70
   STEP 15
180 vsize=hsize
190 CLS
   :PROctree(640,512)
   :PROCdelay(50)
200 NEXT hsize
210 FOR hsize=15 TO 95
   STEP 15
220 FOR vsize=5 TO 65
   STEP 15
230 CLS
   :PROctree(640,512)
   :PROCdelay(50)
240 NEXT vsize
250 NEXT hsize
260 CLS
270 hsize=13
   :vsize=13
280 FOR X=160 TO 1200
   STEP 320
290 FOR Y=100 TO 900
   STEP 200
300 PROCmusic
   :PROctree(X,Y)
310 NEXT Y
320 NEXT X
330 PROCdelay(150)
   :CLS
340 hsize=50
   :vsize=55
350 PROCtree(640,550)
360 PROCtrunk(-1,1,-4
   ,-3)
370 PROCballs
380
390
400 VDU 29,0,0
   :colour1=0
   :colour2=1
410 FOR X=0 TO 1279
   STEP 16
420 PROCmusic
430 FOR Y=0 TO 64 STEP 8
440 GCOL 0,colour1
   :PLOT 69,X,Y
   :PLOT 69,X+8,Y+4
   :REM BOTTOM LINE
450 PLOT 69,X,Y+955
   :PLOT 69,X+8,Y+959
   :REM TOP LINE
460 GCOL 0,colour2
   :PLOT 69,X+8,Y
   :PLOT 69,X,Y+4
470 PLOT 69,X+8,Y+955
   :PLOT 69,X,Y+959
480 NEXT
490 colour1=colour1+1
   :IF colour1=8
   THEN colour1=0
   :colour2=colour2+1
   :IF colour2=8
   THEN colour2=colour1
500 NEXT
510
520
530 VDU 29,0,0
   :colour1=0
   :colour2=1
540 FOR Y=72 TO 953
   STEP 8
550 PROCmusic
560 FOR X=0 TO 128
   STEP 16
570 GCOL 0,colour1
   :PLOT 69,X,Y
   :PLOT 69,X+8,Y+4
   :REM LEFT
580 PLOT 69,X+1143,Y
   :PLOT 69,X+1151,Y+4
   :REM RIGHT
590 GCOL 0,colour2
   :PLOT 69,X+8,Y

```

Turn to Page 121



# Try us for quality software

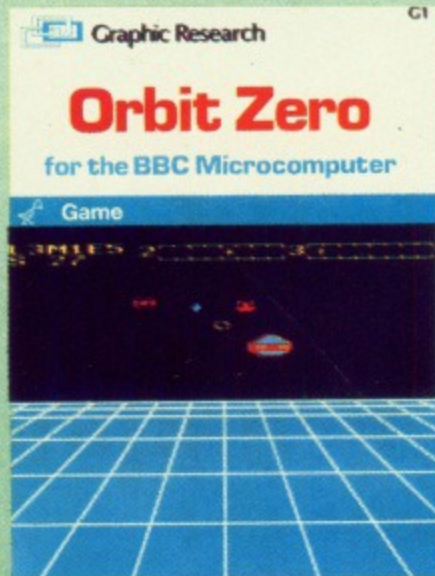

## For the BBC Microcomputer

### Orbit Zero

A dynamic game more dependent upon tactics than reactions. You have to destroy Bombers set on annihilating Earth. The Bombers are defended by two fighters armed with Energy Blasters and homing missiles. Get them in your gun sights and fire your Mega-bolts.  
BBC 32K A or B  
Keyboard or joystick  
Cassette £9.95 incl.



### Minefield

A game of logic and deduction. You have to find a safe path across the dangerous minefield divided into a grid. Each square when visited displays the number of adjacent mined squares – but not which ones!  
BBC 16K A or B  
Keyboard control  
Cassette £6.95 incl.

These programs will run on all operating systems and Basics.

Available from selected dealers or order direct from:

## Graphic Research Ltd

3 Pix Road, Stotfold  
HITCHIN, Herts. SG5 4HU

Cheques and postal orders made payable to:  
Graphic Research Ltd (P & P free)

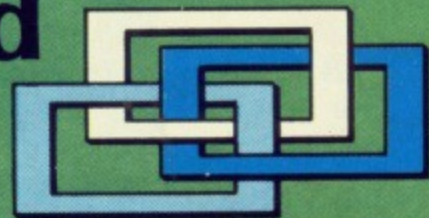

Dealers' enquiries welcome. Tel: (0462) 834141  
24 hour answer service

Authors! We pay excellent royalties for quality software. Please write to the above



# Not top of the pops perhaps, but try playing this

*THE Editor crept up behind me as I was finishing Peters' First Concerto for BBC Micro (with optional disc drive accompaniment). The first I knew of it was when he pressed Break and started cackling as he saw the look on my face.*

*"Cheer up", he crowed, "you're taking all this sound and music too seriously. It's getting out of proportion".*

*"In fact", he added, "you should keep it all in scale".*

*He reached his office before I reached him.*

By  
**NIGEL PETERS**

**SURPRISINGLY** he was more accurate than he thought because this month we'll be covering musical scales. Not that I intend to give you a music lesson - I wouldn't dare - but I will show you the basics of producing simple tunes with your micro.

In the last article we examined the SOUND command and learned how to use it to produce noises. Each of these separate noises is technically called a note and by putting together a series of notes we get a tune.

It should be pointed out that some series of notes are more tuneful than others - as you may have found with the random music generator!

This is because the human ear has come to expect a certain consistency in the notes that make up tunes.

It wants them to go up and down, or change pitch, by regular amounts.

```
10 REM PROGRAM I
20 FOR pitch=0 TO 255 STEP 4
30 SOUND 1,-15,pitch,20
40 SOUND 1,0,pitch,20
50 NEXT pitch
```

Program I

```
10 REM PROGRAM II
20 FOR pitch=0 TO 255 STEP 1
30 SOUND 1,-15,pitch,20
40 SOUND 1,0,pitch,20
50 NEXT pitch
```

Program II

```
10 REM PROGRAM III
20 FOR pitch=0 TO 255 STEP 8
30 SOUND 1,-15,pitch,20
40 SOUND 1,0,pitch,20
50 NEXT pitch
```

Program III

```
10 REM PROGRAM IV
20 pitch=50
30 REPEAT
40 SOUND 1,-15,pitch,20
50 READ increase
60 pitch=pitch+increase
70 UNTIL increase=0
80 DATA 8,8,4,8,8,8,4,0
```

Program IV

```
10 REM PROGRAM V
20 REPEAT
30 READ note
40 IF note=0
   THEN END
50 SOUND 1,-15,note,10
60 UNTIL FALSE
70 DATA 30,30,38,26,30,38,0
```

Program V

Try running Program I.

This goes upwards in a series of steps called semitones. It does this by adding four to the pitch parameter of the SOUND command each time round the loop.

These semitones are the natural building blocks of western music. When tunes go up and down in pitch (higher or lower, soprano or bass) they tend to do so in semitones or groups of semitones.

Even though Program I will probably have you pressing Escape before its end, you'll find it a lot more acceptable than Program II which goes up in steps of one, a quarter of a semitone.

Since we've been talking about semitones you might expect that we'll be coming to whole tones and this we do with Program III.

This program plays a series of notes, each successive note being raised in pitch by one tone (or two semitones). So

increasing the pitch parameter by four raises the note by a semitone; increasing it by eight produces a note one whole tone higher.

Higher notes require different combinations of four and eight to be added to the pitch parameter.

The trouble with the previous programs is that although they worked in tones and semitones, the natural building blocks of music, they were boring.

They leave you with that "waiting for the other boot" feeling!

This is because our ears not only expect tunes to be composed of notes which vary in pitch by tones and semitones, but also they prefer certain selections of the available notes. Try running Program IV.

Much more satisfying, isn't it? It has a complete feeling about it.

After the first note is played the following notes are increased in pitch by the amounts shown in the DATA statement.

As you'll expect by now, these







## From Page 83

increments are all fours and eights, but they are in an order that sounds pleasing to the ear.

This is known as a scale, and most tunes are made up of combinations of notes picked from one scale.

To recap, nearly all the tunes you know consist of series of notes whose pitch changes in multiples of tones and semitones. The notes go up and down in discrete bundles made up of these measures and most tunes confine themselves to a selection of the available notes.

What this means for the BBC Micro is that if you're trying to write a tune you know that after you've picked the start note all the other notes will have the start note's pitch parameter varied by factors of four or eight.

Of course the channel, loudness and duration of the note may vary as well but in this article let's concentrate on the pitch.

It's much easier to use in practice

than to describe. Try running Program V.

This produces a fairly uninspiring version of a well-known tune. It's hardly wonderful music but you can see from the DATA statement how the pitch parameter of the notes varies by factors of four or eight from the pitch parameter of the first note.

Once I had the first note it was just a matter of figuring out whether the next note was up or down and adding or subtracting the fours and eights as necessary.

Then I just put them in a DATA statement and let the loop read the pitch and play the tune.

You can play your own tunes by putting in your own DATA statements. The problem is that you have to figure out which DATA statements produce which notes. Program VI will help you with this.

It is a very simple one which allows you to write micro music by ear.

It begins by asking you for the pitch and duration parameters of the tune's

first note. The micro then plays this and asks you if you want to keep it.

If you do, it will save the note and ask you if you want to play the tune. The program carries on like this, asking for the parameters of notes, playing them and, if required, saving them.

When you finally decide to hear the tune it will play it and display the DATA statement values used.

It's simple to write tunes using this program. When you want to play them just modify PROCreadnote and PROCplaystring.

Of course, this has been a fairly limited treatment. Only one of the BBC Micro's four channels has been used, and we haven't varied the loudness at all. Also we've avoided playing more than one note at a time and producing harmonies.

All this, and more, will follow. But I have to finish now. I've been working for far too long for too little pay, so I'm going into the Editor's office, waking him up and demanding a raise.

*I call it making my pitch.*

```
10 REM PROGRAM VI
20 counter=1
30 PROCnote
40 PRINT
   :PRINT
50 PRINT "Data Statements:"
60 PRINT
   :PRINT
70 PRINT tune$
80 END
90 DEF PROCtune
100 REPEAT
110 PROCreadnote
120 PROCplaystring
130 UNTIL counter>=LEN (tune$)
140 ENDPROC
150 DEF PROCnote
160 CLS
170 INPUT "Pitch of note?"pitch
180 PRINT
   :PRINT
190 INPUT "Duration of note?"duration
200 PRINT
   :PRINT
210 SOUND 1,-15,pitch,duration
220 PRINT
   :PRINT
   :PRINT
230 PROCkeepnote
240 ENDPROC
250 DEF PROCkeepnote
260 PRINT "Keep this note?"
270 PRINT "Press Y and Return for
   YES"
280 PRINT "Any letter and Return
   for NO"
290 PRINT
   :PRINT
300 INPUT key$
310 IF key$="Y" OR key$="y"
   THEN PROCstring
   ELSE PROCnote
320 ENDPROC
330 DEF PROCstring
340 tune$=tune$+STR$ (pitch)+","
   +STR$ (duration)+","
350 CLS
360 PRINT "Play the tune now?"
370 PRINT
   :PRINT
380 PRINT "Press Y and Return for
   YES"
390 PRINT "Any other letter and Return
   for NO"
400 INPUT key$
410 IF key$="Y" OR key$="y"
   THEN PROCtune
   ELSE PROCnote
420 ENDPROC
430 DEF PROCplaystring
440 pitch=VAL (pitch$)
450 duration=VAL (duration$)
460 SOUND 1,-15,pitch,duration
470 SOUND 1,0,pitch,0
480 ENDPROC
490 DEF PROCreadnote
500 pitch$=""
510 REPEAT
520 IF MID$(tune$,counter,1)<>","
   THEN pitch$=pitch$ +MID$(tune$
   ,counter,1)
530 counter=counter+1
540 UNTIL MID$(tune$,counter-1,1)=
   ","
550 duration$=""
560 REPEAT
570 IF MID$(tune$,counter,1)<>","
   THEN duration$=duration$ +
   MID$(tune$,counter,1)
580 counter=counter+1
590 UNTIL MID$(tune$,counter-1,1)=
   ","
600 ENDPROC
```

Program VI



# The **BBC** Microcomputer Specialists

GUILDFORD COMPUTER CENTRE offers a complete range of Computers for Home, Business and Educational applications.

Large stock of additional equipment available includes:- Printers, Hard/Floppy Disc drives, Monitors etc., for most makes.

An extensive range of Business software (Accounts, Stock, Payroll, Word Processing etc.).

Drop in for a frank discussion and expert advice on your requirements or arrange a demonstration. We give a full and expert backup to ALL our sales.

Stockists of:- BBC/Acorn, Torch, Oric, Olivetti, Hitachi, TRS-80, Commodore, Dragon, Sharp, Sirius, Osborne, IBM, Newbrain, Epson, Seikosha, Cumana, etc.

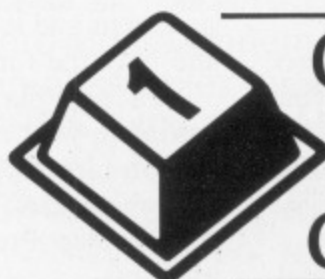

**GUILDFORD  
COMPUTER  
C·E·N·T·R·E**

 **commodore**

**olivetti**



 **HITACHI**

**BBC**

**TRS-80®**

1 The Quadrant, Bridge Street,  
Guildford, Surrey GU1 4SG  
Telephone (0483)578848

## ORION SOFTWARE

PROFESSIONAL  
PROGRAMS  
FOR THE MODEL B.

SPACE TANK 'Current Best Seller' £6.95

After your SPACE TANK has landed on the planet Orion, a series of alien tanks, surface hoppers, and spacecrafts will attack. How long can you hold out commander? This game makes use of the Beeb's fast scrolling ability. Can be used with either keyboard or joysticks. Top ten table.

STAR HAWKS £6.95

Can you stop the STAR HAWKS before they stop you? Slow work means the generation of more laser firing mutant hawks. Based on the games of Galaxian and Gorf. Can be used with either keyboard or joysticks. Top ten table.

HORSES 'New' £6.95

Come on now, don't be shy, get up on your horse and let's see what you can do. Can you complete the round of fences in the arena especially with the clock ticking away? Can be used with either keyboard or joysticks. Top ten table.

DESIGN £4.95

If you like watching your user defined characters run around the screen but are fed up working out the mathematics, then DESIGN is for you! With DESIGN you can draw your characters on an 8x8 grid and let the machine do all the work. DESIGN's features include being able to recall characters for re-editing, displaying VDU 23 commands, and amendable cursor. All characters used in Orion Software programs are created using DESIGN.

Dealer and other enquiries welcome.

MAIL ORDER ONLY.

HANGMAN £5.95

Let words become fun again with our three languages, (ENGLISH, FRENCH, ITALIAN), version of the popular game of HANGMAN. There are 3 levels of play for each language. All words can be replaced or removed, and new ones can be added. HANGMAN comes with an instruction program giving full details for parents and teachers. Once running prying eyes cannot access the word lists!

EARLY YEARS 1 & 2 'New' £7.95 EACH

Dad has got his 'grand prix driver', Mum has got her 'recipes', Jimmy has got his 'space invaders', Susie has got her 'record filer', but what has your most recent little bundle of joy got? There are many 'educational' programs around that deal with the school years but what about those early years? Have you ever let your 'bundle' near the keyboard? Come on mum and dad, help your 'bundle' get Fred the Frog to the other side of the pond, Sid the Spider through the simple maze. Both of the EARLY YEARS programs have a series of tasks for either a parent or teacher to take a young child through. Simple button pressing, colour recognition, sorting, numbers 1-10, addition, subtraction, shapes, sizes, and directions are explored. Your 'bundle' can be left after a few runs to enjoy, (and learn), from many of the game type problems that are set. For 'bundles' between 4-8.

FREE with all orders is our 3 level version of NOUGHTS AND CROSSES!!!

ORION SOFTWARE,

11 Buttercup Close, Romleighs Park, Harold Wood,  
Essex RM3 0XF.



# BX-80 COLOUR PRINTER

*Designed for use with the BBC Micro*  
Prints in 7 colours on plain paper  
Colour screen printing in ALL Modes (inc. Mode 7)

Uses RS423 output. Cable supplied  
(Note: OS 1.2 only)

Printer RS423 input has 3.5Kbytes buffer  
Special Mode 7 Teletext 2 page store with  
printout size option.

125 CPS primary colour speed for listing,  
etc. (5 x 7 matrix)  
Screen dump listing supplied

ONLY **£495** + VAT



Black & White Interface Card with 3.5Kbytes  
buffer for Epson MX80\*/RX80/FX80.

All BBC Micro modes, including  
Teletext Mode 7.

Board. RS423 cable plus software  
ONLY £95 + VAT

Apple II parallel interface card for  
MX80\*/RX80/FX80 high resolution  
screen dumps, C/W cable.

ONLY £59 + VAT

Apple II colour dump disc for BX80 £9 + VAT

\*MX80 requires printer ROM change... add £15 + VAT

## INTEGREX LTD.

Church Gresley,  
Burton on Trent, Staffs DE11 9PT.  
Tel: (0283) 215432. Telex: 377106.  
Prestel: 200650





# LVL COMPUTERTOWN

**WE WISH YOU  
A MERRY CHRISTMAS  
AND OFFER YOU  
A MICRO CHIP NEW YEAR**

LVL COMPUTERTOWN OFFERS YOU ENTERTAINING, EDUCATIONAL, PRACTICAL PRESENTS, THIS CHRISTMAS FOR ALL THE FAMILY - TOTS, TEENAGERS, MUMS AND DADS - AND AT PRICES THAT'LL MAKE YOU CELEBRATE.

## P.L. GRAPHICS SYSTEM

**WILL UNCHAIN THE GRAPHICS POWER  
OF YOUR BBC MODEL B MICRO**

AN EASY TO OPERATE COMPLEX GRAPHICS SYSTEM WITH VERY ADVANCED SOFTWARE CONTAINING FIVE PROGRAMS GIVING A POWERFUL AND VERSATILE COMPUTER AIDED DESIGN SYSTEM

COMPLEX PICTURES AND DIAGRAMS, OR ORIGINAL DESIGNS CAN BE QUICKLY, EASILY AND ACCURATELY REPRODUCED.

FOR USE IN EDUCATION, BUSINESS, DRAWING OFFICE DESIGN STUDIOS AND THE HOME.



**£149.95**  
(including VAT)

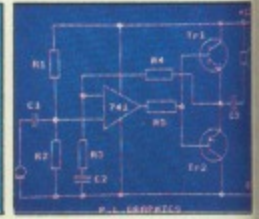

## SOFTWARE BBC MICROCOMPUTER

DESIGNED FOR THE  
BBC  
MICROCOMPUTER

MODEL A £299 MODEL B £399 (INCLUDING VAT)



### EDUCATIONAL

Business Games	£9.95
Tree of Knowledge	£9.95
Peeko Computer	£9.95
Algebraic Manipulation	£9.95
Word Sequencing	£11.90
Missing Signs	£11.90
Number Balance	£11.90
Word Hunt	£11.90
Density Circuit	£11.90
Chemical Analysis	£13.80
Chemical Structures	£13.80
Jars	£11.90

### GAMES

MONsters	£9.95
Snapper	£9.95
Planetoid	£9.95
Arcade Action	£11.90
Rocket Raid	£9.95
Meteors	£9.95
Arcadians	£9.95
Sliding-Block Puzzle	£9.95
Cube Master	£9.95
Starship Command	£9.95
Snooker	£9.95
Super Invades	£9.95
Hopper	£9.95
Colditz	£9.95

(including VAT)

## BOOKS



### ACORN

Creative Graphics	£8.63
Graphs and Charts	£8.63
Lisp Book	£8.63
Forth Book	£8.63
BCPL Manual	£17.25

### BBC

The Computer Book	£7.76
The Book of Listings	£4.31



### MONITORS

#### DECCA COLOUR

14" COLOUR MONITOR  
£247.25  
(including VAT)

#### MICROVITEC

14" COLOUR MONITOR  
£247.25  
(INCLUDING VAT)

#### SANYO

12" GREEN SCREEN  
£102.35  
(INCLUDING VAT)



## WE HAVE THE TECHNOLOGY

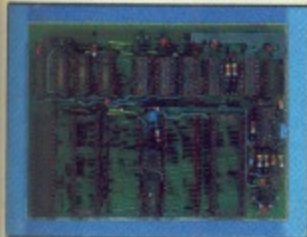

# L-DOS

The Complete Double Density Interface for the BBC Microcomputer offers.

- Double Density
- Up to 248 Files
- Automatically Checks for Correct Density
- Simple to Fit
- Utilities provided
- Defaults to Single Density on power up
- 40 or 80 track
- BBC FDS Compatible
- Own PCB with separate 8 Mhz Clock

**£90.85**  
(including VAT)

- No links to change
- No Soldering
- User definable density
- Single or Double sided

## electron



LVL Computertown Specialists will be amongst the first to offer you the electron. The new personal computer from ACORN Computers. An ideal machine for learning computing - and for having a lot of fun at the same time.

But it's much more than just a toy. Its graphic facilities are the most sophisticated available in its price range.

**£199.00**  
(including VAT)

**AVAILABLE SHORTLY**

## TRI-WRITER



- \* IT'S A PORTABLE COMPUTER TERMINAL!
- \* IT'S A LETTER QUALITY COMPUTER PRINTER
- \* IT'S A FULL FEATURE ELECTRONIC TYPEWRITER

**£734.85**  
(including VAT)

NEVER BEFORE, AT ANY PRICE, HAS THERE BEEN AN INNOVATION LIKE TRI-WRITER! AND AT THIS LOW-COST, IT'S ALMOST UNBELIEVABLE! NOW EVERYONE CAN HAVE ALL THREE FUNCTIONS .....IN ONE MACHINE, AND AT A COST BELOW WHAT YOU WOULD EXPECT TO PAY FOR A SINGLE FUNCTION MACHINE!

The items featured represent a very small selection from our vast product range. For further information of both product and services available. Call or telephone your nearest LVL COMPUTERTOWN Dealer. And take the wraps off the best Christmas you'll ever have.

### CHESHIRE

C-TECH SOFTWARE  
184, Market St.  
**HYDE**  
Cheshire  
061 366 8223

\* COMPUTER CITY  
78, Victoria St.  
**WIDNES**  
Cheshire  
081 420 3333

\* OAKLEAF COMPUTERS  
100, Boughton  
**CHESTER**  
0244 310099

### CUMBRIA

\* THE COMPUTER SHOP  
96/98 Lowther St.  
**CARLISLE**  
Cumbria  
0228 27710

### ESSEX

A.C.L.  
1, Northmall  
**GRAYS, ESSEX**  
0375 79834

BROADWAY MUSIC  
AND VISION  
Woodford Green  
**ESSEX**  
01 504 7500

### GREATER MANCHESTER

\* LOMAX  
8, Exchange St.,  
St. Annes Square,  
**MANCHESTER**  
061 832 6167

### MERSEYSIDE

\* THORNGUARD  
46, Pensby Rd.,  
**HESWALL**  
The Wirral,  
Merseyside  
081 342 7516

### NOTTS'

\* BASIC BUS. SYS.  
Trent Boulevard  
**WEST BRIDGFORD**  
Nottingham  
0602 819713  
S P ELECTRONICS  
48, Linby Rd.  
**HUCKNALL**  
Notts.  
0602 640337

LEASALINK VIEWDATA Ltd  
230, Derby Rd.  
**STAPLEFORD**  
Notts.  
0602 399484  
M. C. E.  
79, Ratcliffe Gate,  
**MANSFIELD**  
Notts.  
91 31202

### OXFORD

ABSOLUTE SOUND  
AND VIDEO (Oxford) Ltd.  
19, Old High St, Headington  
**OXFORD**  
0865 65961

### AVON

K & K COMPUTERS  
32, Alfred Street,  
**WESTON SUPERMARE**  
Avon  
0934 419324

### WARWICKSHIRE

CARVELL  
9, Bank St.  
**RUGBY**  
Warwickshire  
0788 65275

### WEST MIDLANDS

RICHARD MORRIS  
523, Bearswood Rd.  
Smethwick  
**WARLEY**  
021 429 1161  
JBC MICRO SERVICES  
200 Earlsdon Ave,  
Nth. Earlsdon  
**COVENTRY**  
0203 78813

### WILTSHIRE

WILTSHIRE MICRO  
CENTRE  
47, Victoria Rd.  
**SWINDON**  
Wilts.  
0793 612299

### BUCKS'

HI-VU ELECTRONICS  
38, Church St. Wolverton  
**MILTON KEYNES**  
Bedford  
0908 312808

### SUSSEX

C.J.E. MICROS  
78, Brighton Rd.  
**WORTHING**  
West Sussex  
0903 213900

### ISLE OF WIGHT

EXCELL  
4, Foreland Rd.  
**BEMBRIDGE**  
Isle of Wight  
098 387 2578

YOUR LOCAL



DEALER

### HEREFORD

KEMPSONS  
26, Over St.  
**HEREFORD**  
0432 273480

### KENT

KENT MICRO  
57, Union St  
**MAIDSTONE**  
Kent.  
0622 52784

### NORTHANTS'

M A ELECTRICAL  
7, High St.  
**IRLINGBORO**  
N'Hants  
0933 650133

### LEICESTER

PERCY LORD & SON  
63, Blaby Rd.  
**WIGSTON**  
Leicester.  
0533 785033

### LINCOLNSHIRE

\* OAKLEAF COMPUTERS  
121, Dudley Rd.  
**GRANTHAM**  
0476 70281

### LONDON

CANNONBURY RADIO  
185 Upper St.  
**ISLINGTON N1**  
London  
01 226 9392  
PAUL ELECTRICAL  
280/2 Grand Drive,  
Raynes Park,  
**LONDON SW20**  
01 542 6546  
WOODS RADIO  
257, Lavender Hill.  
Battersea,  
**LONDON**  
01 228 1766

### SALOP

MEDLICOTT BROS  
53, Mardol  
**SHREWSBURY**  
Shropshire  
0743 3060

### SUFFOLK

S J EMERY & CO.  
10, Market Place  
**BUNGAY,**  
Suffolk  
0986 2141

### NORTH LAND

NEWTONS  
Main St.  
**SEAHOUSES**  
0665 720307

### STAFFS

J W BAGNALL  
18, Salter St.,  
**STAFFORD**  
0785 3420  
KIRKLANDS  
City Rd., Fenton.  
**STOKE ON TRENT**  
0782 415787

\* COMPUTERAMA  
59, Foregate St.  
**STAFFORD**  
0785 41899

### SURREY

\* HASLEMERE COMPS  
25, Junction Place.  
**HASLEMERE**  
Surrey  
0428 54428

P & H ELECTRONICS  
5, The Parade,  
Reading Road,  
**YATELEY**  
Surrey.  
0252 - 877 222

\* Spectrum Members

### LANCASHIRE

\* P V MICROS  
38A Water St.  
**ACCINGTON**  
Lancs.  
0254 36521

\* Home & Business  
Computers Ltd.  
54, Yorkshire Street,  
**OLDHAM**  
061 633 1608

Home & Business  
Computers (RCH) Ltd.  
73, Yorkshire Street,  
**ROCHDALE**  
0706 344654

### WALES

BULWALK RADIO  
5, The Bulwalk.  
Brecon.  
**POWYS**  
0874 2974  
BUCON  
18, Mansel St.  
**SWANSEA DY FFD**  
0792 467980  
S.I.R.  
91, Whitchurch Rd.  
Cyncoed  
**CARDIFF**  
Wales  
0222 21341/759015

### SCOTLAND

COMMSCOT  
30 Gordon St.  
**GLASGOW**  
041 226 4878

### IRELAND

EVERYMAN COMPUTER  
SERVICES  
**BALLYMONEY**  
Co-Antrim  
N. Ireland  
026 56 62658



# Play with a Griffin

So they take school in their stride



Your children are using a computer at school far more often than you think.

Computers make learning an absorbing game and retain a child's interest and participation.

Griffin Software have selected and adapted for home use, a series of Griffin educational software titles already used in schools.

The first six titles suitable for 4 to 8 year olds, are available now.

If you have a ZX Spectrum 48K or a BBC Model B microcomputer at home, you can so easily keep up the school's good work. And the beauty of it is, the child sees it as a game!

Wordspell helps with spelling; Tablesums unravels the mysteries of tables; Fairshare uses Ollie the Octopus to make sense of division; Numberfun makes addition and subtraction easy; Wordgames helps with spelling and expands vocabulary; and with Getset a child is helped with counting.

All good fun!

Griffin Software titles are at WH Smith, Boots, and other computer shops everywhere.



Only £7.99 each to suit the ZX Spectrum 48K Only £9.95 each to suit the BBC Model B

**GRIFFIN SOFTWARE**  
- it's an education.



Eight socket ROM board.  
Smartmouth speech synthesiser  
Both from Technomatics

## Software only an asterisk away

A ROM extension board gives you the chance to add more than the four possible language or utility ROMs to your BBC Micro. For example, I have Beebcalc, Wordwise, CPN, Basic and the Watford DFS chips.

There are ROMs available with Pascal, Logo, print and disc editing utilities. And I hope more will follow. Certainly the BBC Micro becomes very powerful with so much software only a \* command away!

ROM extension boards are not easy to fit. Acorn have not socketed the relevant chips (IC76 and IC20) and one must either desolder the chip and put a socket on the board, or solder leads directly to the chips.

Though able to be done by a competent technician, my advice is that this is a job for your dealer. The BBC board is delicate, the chips close together and mistakes difficult to rectify.

There is another problem. Not all BBCs decode these ROMs in the same way. In theory, the most right hand ROM socket has the highest priority

and as you progress towards the 0.1 or 1.2 OS ROM, the priority gets less.

This was certainly not the case on my board. The ROM socket furthest to the right had the highest priority, but after that it was a little strange. Things were made worse when I fitted the ROM extension board.

This is important because different ROMs can take priority over each other and must sit in the right priority socket. For instance, if you have two DFS chips fitted it is the highest priority DFS that handles all default filing and so on.

If, like me, you have the CPN ROM but usually want Basic first, then the priority order must reflect your wishes.

The highest priority is ROM 15. You can detect which ROM socket your machine thinks it is accessing by the following:

```
Type into the machine:
*FX 252,0
Return
Break
```

Then reset the machine with CTRL + Break and change the 0 after the comma to another number from one to 15. Repeat this until you have tracked your ROMs.

When you press Break after the \*FX 252 call, the machine "bombs" into the ROM whose number you have specified.

The Technomatics board slots into the most right hand ROM position. It sits just under the keyboard and across the top of the under-board connectors. Thus it can keep as cool as possible.

Other extension boards tend to move into the heart of the micro and can get very hot indeed, which may cause problems later.

The board is well made, adequately insulated from any other electrical components with some of the best quality sockets I have found on a low cost commercial board. This is important if you are continually going to take ROMs in and out of your sockets.

The board has been sitting in my micro for a month now. After the initial pangs of fitting, it has performed well. But along with the Z80 card and other additions, my BBC Micro can get quite hot. This has led to inadequacies in the 6522 chip servicing the keyboard being shown up.

I understand this may be a far more common problem than yet has come to light. After a few hours of operation either the keyboard will not respond or certain keys behave strangely. Like all good bugs it is rare, random and a devil to trace.

If you do fit additional boards then be aware that, though the BBC power supply is more than adequate, some chips on the board are very sensitive to temperature. You may think that your micro is cool - but it isn't!

It will be a difficult choice between the Technomatics and Watford extension boards. On "pence per ROM" Watford wins, but your board is more likely to heat up.

I prefer to play it safer with the Technomatics board. The choice is yours.

Paul Taylor

Ian Murray

## SMARTMOUTH'S NO SWEET TALKER

SMARTMOUTH is an implementation of the allophone technique for speech synthesis.

It produces speech by accessing individual sounds, and words are built up by voicing these in quick succession. It is thus not necessary to know how a word is spelled but how it sounds!

You can then build up the word phonetically using one allophone after another.

Smartmouth comes in a small plastic box with an inbuilt speaker. There is also an audio output for connection to an amplifier if required. It attaches externally to the BBC Micro, power and data being supplied from the micro via the user port. There are two programs on cassette and a six page manual to help you master its working.

The programs consist of a development aid and a demonstration of its use.

The manual has a table of the 64 allophones provided, some hints on how to get the best out of the unit, instructions on how to access the unit from a program and a single page of examples. This is very helpful though it would have been useful to have more examples supplied.

The speech from this unit is understandable but not of the same quality as from the Acorn speech ROM. The voice lacks any intonation and really sounds like a computer. It is, however, very easy to produce new words once you get used to what the allophones sounds like.

It is also worth remembering that even a lengthy word such as "synthesiser" can be formed in only 11 bytes so memory overheads are negligible.



# Make your Micro the life and soul of the party

WITH the festive season once more upon us, here is a little add-on that will make your BBC Micro a welcome guest at any party. As well as being available in kit form, it can also be purchased ready-built for the less intrepid among you.

It is a little-known fact that I used to be a disc jockey in my early youth. The truth of the matter was that I enjoyed wiring up all the amplifiers, turntables and tape decks.

Such was the mess of wiring spaghetti that I was the only one who would dare operate it. It also fell to my lot to wire up the disco lights and to flash them on and off. This was in the Dark Ages when such a thing was a novelty.

However, the control of disco lights was one of the first things I automated. A natural progression was to make the music control the switching of the lights.

When lights are fixed, the results produced do not get very complicated, but the overall effect adds great atmosphere to any party.

I have always had the feeling that something better could be done and for a long time have wanted to do something similar with a computer.

However, not until the advent of the BBC Micro has a computer incorporated sufficient facilities to make this project worthwhile.

This month's exercise is therefore an add-on which produces patterns related to music or, if you have built the solid state relay (see the September issue of the *Micro User*), controls conventional spot lights.

If you look at music on an oscilloscope you will see a complex ever-changing waveform. In fact it looks a mess. This is because when you use an oscilloscope you are looking at the signal as a plot of amplitude against time, known as a "time domain" view of the signal.

If, however, you take a short section of music (say half a second) and make a plot of the amplitude at each specific pitch you have what is known as a "frequency domain" view of the signal. This can be displayed using an instrument known as a spectrum analyser. (No, it doesn't work out what is wrong with rubber computers!)

The frequency domain view of a signal (or, as we say, its spectrum) shows, at any instant, the composition of the sound in terms of pitch. For most music, this means which instruments were playing at the instant the spectrum was taken.

So all we need for a picture of the sound is to feed our hi-fi into a spectrum analyser. As these cost around £3,000 it is not a very practical proposition.

We can make a crude simulation of a spectrum analyser by filtering the sound so that only a restricted band of frequencies is produced. This can be done with a band-pass filter.

If several band-pass filters are used, all at different frequencies, we can build up an approximation of the spectrum of the sound.

Figure I illustrates the principle: the sound is split up into four frequency-bands and the output of each filter is

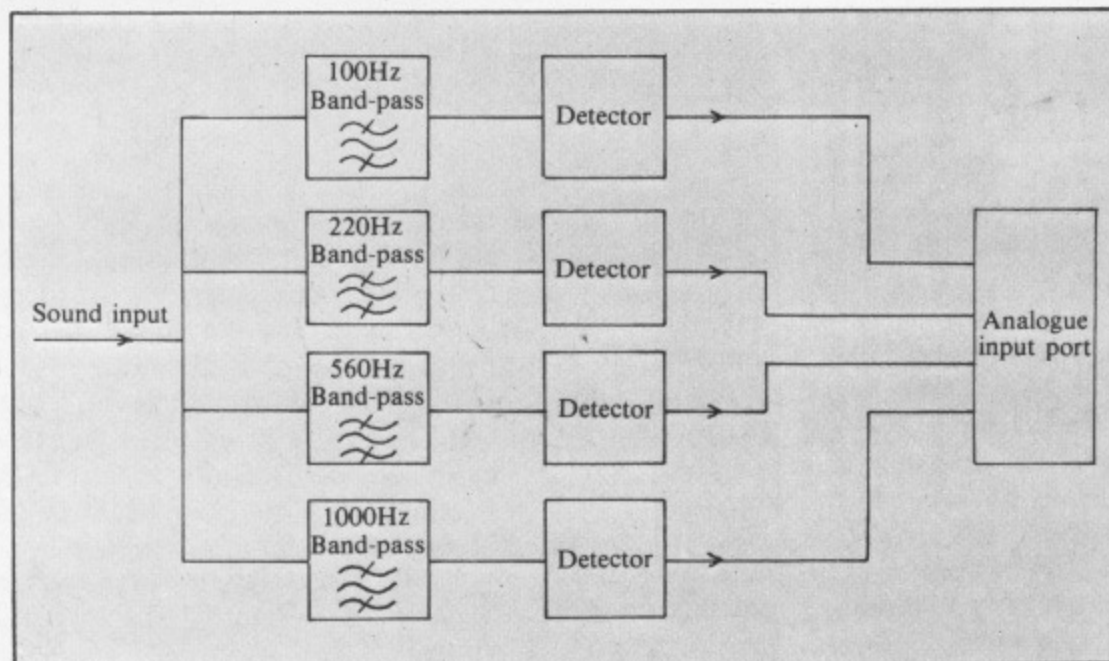

Figure I: Block diagram of our spectrum analyser

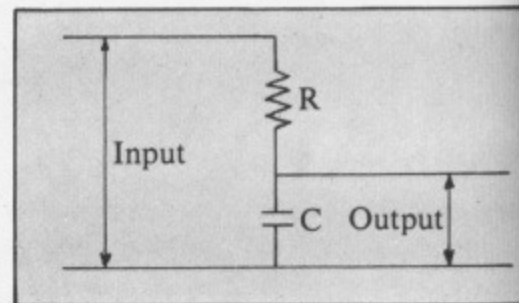

Figure II: A low pass filter

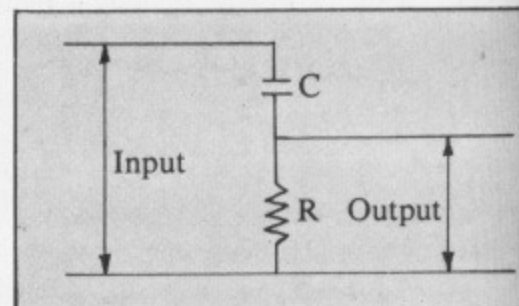

Figure III: A high pass filter



# THE BEEB BODY BUILDING COURSE

## PART 10

measured in order to build up the spectrum.

In terms of our ultimate goal, the samples can then be used as parameters to create patterns on the computer's display. The problem is to build four filters which will cover the same range of frequencies as the music.

A simple filter can be made with a capacitor and resistor. (See Figure II.) A capacitor does not allow DC to flow through it, only AC. The higher the frequency of this current, the more easily it flows.

In jargon we say the capacitor has a high impedance for low frequencies and a low impedance for high frequencies. Therefore a capacitor can be thought of as a frequency-dependent resistor.

So you will see in Figure II that if the input is a high frequency the output will be small, because the impedance of the capacitor is much smaller than the impedance of the resistor.

Conversely, for a low frequency input, the capacitor has such a high impedance it can be considered effectively removed. So the output will be the same as the input. Because low frequencies are passed through unchanged and high frequencies are attenuated (reduced) this is known as a low-pass filter.

See if you can work out why the circuit in Figure III is a high-pass filter.

By combining a high-pass and a low-pass filter we can produce a band-pass filter. Unfortunately, the circuits in Figures II and III are not usable in practice, due to the impedances of the input and output devices. We have to use amplifiers to reduce the effect of "loading impedances" as they are called.

When an amplifier is included in a filter it is called an active filter (not "Active Fitter" as one Ministry of Defence typist once titled a report of mine).

The simplest way of making an active filter is to use an operational amplifier (or op-amp).

Unfortunately, most op-amps need a split power supply, that is, one with a positive and negative voltage as well as a zero volt rail. This is available from the auxiliary power supply socket of the BBC Micro.

However, if you have a negative supply rail there is a danger that the

### By MIKE COOK

output of the op-amp will go negative. This in itself is no problem, but if it is connected to the analogue input of the computer it will damage the A/D converter chip.

A better solution is to use an op-amp which does not need a negative supply. These little-known amplifiers work with input currents (as opposed to input voltages as used by the more conventional op-amps). They are known as Norton amplifiers and the symbol is shown in Figure IV.

These current-differencing amplifiers have been designed to work off single-supply voltages over a wide range (4 to 36 volts) and as such are ideal for use with digital electronics.

Like any op-amp they have two inputs. The first is known as the positive input, because any current flowing into it will be amplified and cause the output to rise. The other input is known as the negative or inverting input - when current flows into it, the output falls

(goes in a negative direction).

The trick of using op-amps is to arrange the feedback circuit (connecting the output to the input) so that these currents balance out and a stable output is achieved for a stable input. This is not nearly as difficult as it sounds.

Consider Figure V. When no voltage is applied at point P, the output voltage will rise due to the current flowing into the positive input. However, as it rises it makes more current flow into the negative input, which tends to force it down. This reaches equilibrium when the same amount of current is flowing in

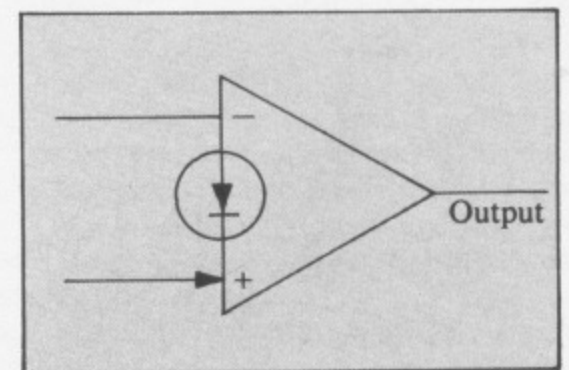

Figure IV: A Norton amplifier

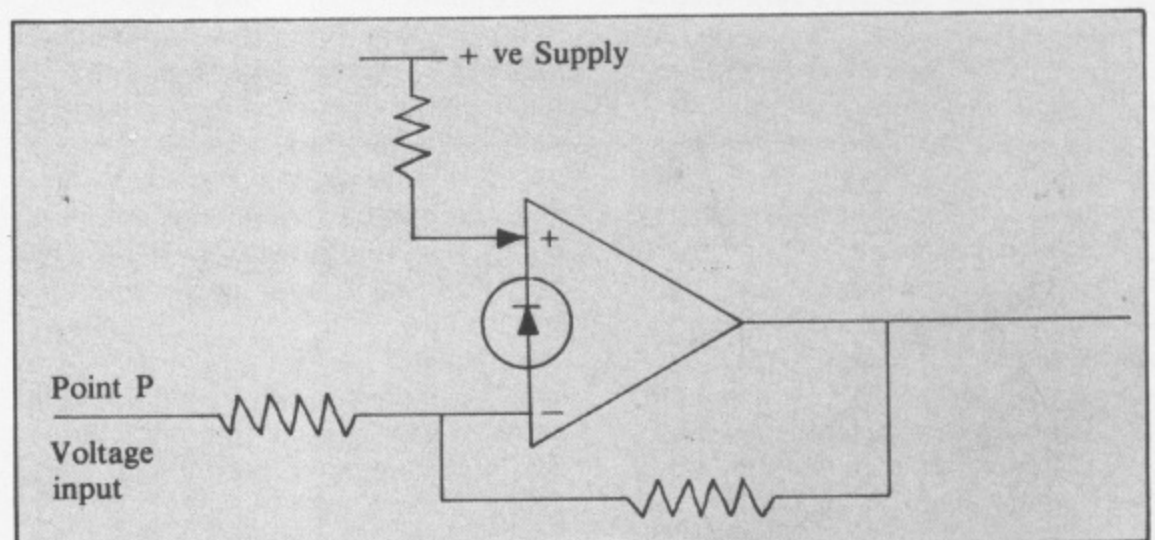

Figure V: An inverting amplifier



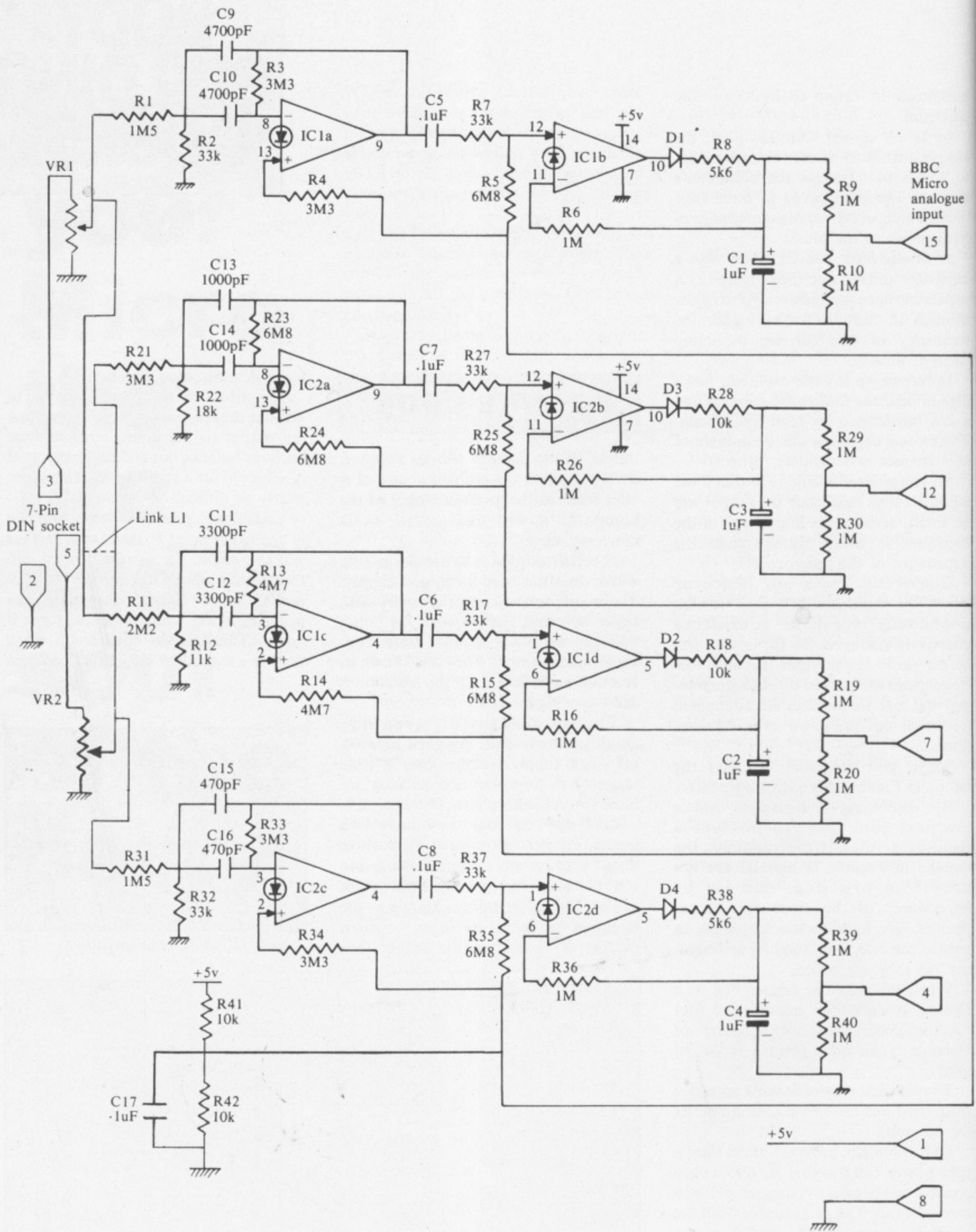

Figure VI: The sound-to-pattern converter



## From Page 93

both inputs of the op-amp.

When the voltage at point P starts to rise, more current flows into the negative input causing the output to fall, thus reducing the amount of feedback current, until again an equilibrium point is reached.

But this time, some of the current in the negative input will come from the signal, and some from the output (feedback). As the output falls when the input signal increases, this configuration is known as an inverting amplifier. You should be able to see that the gain of such an amplifier is controlled by the values of the resistors in the circuit.

If you understood that on the first reading you are doing very well. If not, go back and go through it again and sketch yourself little graphs of the input and output - I find it often helps. The Norton amplifier is available in a chip called the LM3900N. There are four of them, all in the same package.

Now, promise me you won't stop

### Body Build Pack No. 8:

C1-C4 1uF Tantalum capacitor, C5-C8, C17 0.1uF paper capacitor, C9 C10 4700 pF polystyrene capacitor, C11 C12 3300 pF polystyrene capacitor, C13 C14 1000 pF polystyrene capacitor, C15 C16 470 pF polystyrene capacitor, D1-D4 1N4148 Diode, IC1 IC2 LM3900N Norton op-amp, VR1 VR2 10 Skeleton preset pot, 7 pin DIN socket, 2 14 pin DIL IC sockets, 15 way D-Type plug, 2 16 mm plastic pillars, 2 self-tapping screws, printed circuit board.

### RESISTORS 5%

R1, R31	1M5
R2, R7, R27, R17, R32, R37	33K
R3, R4, R21, R33, R34	3M3
R5, R24, R25, R15, R35, R23	6M8
R6, R9, R10, R16, R19, R20, R26	1M
R29, R30, R36, R39, R40	1M
R8, R38	5K6
R28, R18, R41, R42	10K
R11	2M2
R13, R14	4M7
R22	18K
R12	11K

● You can order this, as well as previous Body Build Packs, by using the order form on Page 97.

reading this article, and go and have a peep at Figure VI. Pretty impressive hey? Well actually it's not that complicated, because as we need four filters, the basic circuit is just repeated four times. If you can bear it, have a closer look and you will see that the same circuit really is repeated. Only the component values differ.

Each strip of circuit corresponds to a separate filter/input circuit. The sound signal comes from the input socket. This is a 7-pin DIN socket wired up in exactly the same way as the cassette input socket of the BBC Micro. In this way you can use your cassette recorder to play the music (let's face it, it never was much good for programs!).

If you have a stereo input to this circuit, one channel is controlled by VR1 and the other by VR2. The input socket is wired up to allow this but if you only have a mono system the two halves should be joined together by making link L1.

If you are feeding the unit from the output of a hi-fi amplifier you can wire it up in parallel with the loudspeakers. If you are using stereo, make sure the common lead goes to earth. To be on the safe side, only wire up one speaker wire on one side and two on the other. If both channels do not work you can then safely swap wires until they do.

As the unit has a very high input impedance it will not place any loading on the sound source. A signal of about two volts RMS will be needed to drive the unit, but the sensitivity can be increased by software as we shall see later.

Construction can be done in a number of ways. I made the original prototype on Vero board, with flying leads connecting it to the computer. However, as it is a circuit which quite a lot of people might be interested in, I have produced a printed circuit board. This is available as a kit, with all the components. (See page 97 for ordering details.)

The board uses a 15-way D-type plug and just plugs into the analogue input socket. Two pillars are used at the other end of the board to support it. If you want, however, it may be made in a box to make it look neater, although there is nothing nicer than a well-laid-out circuit.

Construction of the circuit board involves finding the component value from the components list and inserting the appropriate component in the correct place on the printed circuit board. For example, C7 is a 0.1 uF capacitor and should be placed at the

# THE BEEB BODY BUILDING COURSE

component position marked C7 on the printed circuit board.

Note that the resistors only have their number on them, they don't start with 'R'. The diodes need to be placed the right way round. This is shown by the band at one end. Again, match it up with the markings on the printed circuit board.

Apart from the ICs the only other components that need to be the correct way round are the electrolytic capacitors C1 to C4. A small white stripe and a + should be at one end. Put this end to the hole marked + on the board.

The four band-pass filters have their frequencies evenly distributed over the range used for the fundamental notes in most music. The exact frequencies are 100Hz, 220Hz, 560Hz and 1000Hz. Now, hands up all those who think I have made a mistake. Are those frequencies evenly distributed? Well in fact they are, as far as the ear is concerned.

This is because the response of the ear is very nearly logarithmic and so these frequencies sound evenly spaced. If you plot them out on a logarithmic scale you will see there is the same space between them.

Now - hold onto your hats - here is the simple version of how the circuit works. The signal is fed into the input of IC1a through R1 and R2 resistors and the capacitor C10. The feedback is provided by R3 and C9.

As we saw earlier, capacitors act as frequency-dependent resistors, so the amount of signal flowing into the amplifier both from the source and the feedback are frequency-dependent.

At low frequencies, the capacitors can be considered as open circuits. So no signal gets to the input of the amplifier.

At high frequencies, the capacitors are a very low impedance. So although the signal gets through to the input,

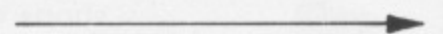



## From Page 95

there is lots of negative feedback and the output does not move very much.

Only at some intermediate frequency is there any output. The resistor R4 provides a steady trickle of current, known as the bias current. This bias supply is provided from a potential divider formed by R41 and R42 and is used to prevent the resistor values becoming too high.

Once the signal has been filtered it is passed to the next stage (IC 1b) which is known as a peak detector.

Capacitor C5 removes any DC component from the signal and feeds it into the input of the next op-amp. Current is also being supplied from R5 and is acting as the bias for this stage. The output of the op-amp is then passed through a diode.

A diode acts as a one-way valve, allowing current to flow from the output of the op-amp into the capacitor, but not allowing the capacitor to discharge back through the amplifier.

Therefore the diode only conducts when the voltage at the op-amp output is higher than that on the capacitor.

Thus the voltage on the capacitor

represents the peak voltage from the amplifier. Resistor R8 controls how fast this peak voltage builds up and R9 and R10 allow this voltage to decay. So the voltage fed into the analogue input socket represents the loudness of the music at that instant. This is known as following the envelope of the music.

All we have to do now is to feed our music signal into this circuit and use the values from the analogue input port to draw our patterns.

As usual I have written a program to illustrate how this is done, which gives very good results. But also, as usual, it is only a starting point for you to experiment with.

The signal being fed into the analogue input port is larger than I required, so it is cut down to size with the variable SCALE%. There is also a DC offset voltage on the input. This is removed by the variable OSET%. These values can be changed to increase the sensitivity of the circuit if the input signal is low.

To test the circuit, you only need to type in lines 10 to 180 (omitting line 150) and lines 950 to 1140.

This displays a bar graph of each input channel so you can make sure that it is moving over a good range. If not,

adjust the volume into the filters either from the source, or by adjusting the variable resistors. Alternatively, alter the two variables already mentioned.

The procedure SAMP samples the appropriate input channel and scales the result so that it is between 0 and 40. This value is returned in the variable V%. The procedure BAR then prints a line of stars proportional to the size of the input.

The display looks very much like the rows of flashing lights you get on some modern hi-fi systems.

Having got that working, you can now type in the rest of the program (not forgetting to add line 150). This uses the sound in three ways to produce moving patterns which seem to be evocative of the music being played.

Each different procedure is ended by pressing a key. If this were being used at a party you might like to end each display procedure after a certain time has elapsed – not forgetting to zero the time at the start of each procedure. The lines that need changing are 670, 930 and 1360.

In order to speed up the patterns, use is made of a lookup table, X%(N) and Y%(N), to convert the sound input

# PLANE SAILING



**Airline**  
Hijacks, strikes, crashes and spiralling fuel costs must all be overcome if you are to succeed at this game. A wing and a prayer will not be enough to turn your £3 million to £30 million in the time allowed, but your financial wizardry will enable you to take over British Airways, or will it?



**Dallas**  
Can you amass enough petro dollars to take over the Euing empire. Cut throat business and an eye for the main chance may get you there but you'll need nerves of steel to overcome the oil king of Dallas.

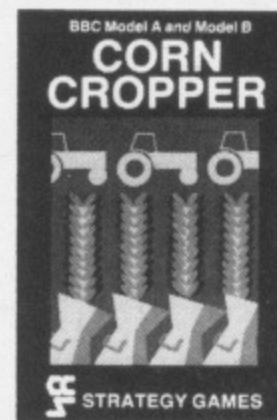

**Corn Cropper**  
Limited cash and droughts are two of the problems facing the farmer. Planting, fertilizing and harvesting must all be done economically if you are to reap the rewards offered in Corn Cropper. You choose the method that will bring you success.



## BUSINESS STRATEGY GAMES – £6.95

Selected titles available from Greens, Boots, Rumbelows and all good computer shops or Cases Computer Simulations Ltd., 14 Langton Way, London SE3 7TL.



# THE BEEB BODY BUILDING COURSE

values to screen co-ordinates. These are pre-calculated in the procedure LOOKUP, along with the initialisation of most constants used in the program. Wherever the program is sensitive to speed I have used integer variables.

The procedure POLYGON uses the value of each sound channel to control the position of each corner of a quadrilateral. This changes shape and distorts in sympathy with the music.

A record of each shape is stored in the array OX% and OY% (old X and old Y) and when there are N% shapes displayed the oldest of them is removed to make way for a new one. This prevents the screen becoming cluttered with remnants of old patterns.

The display responds rapidly to the change in music and is very effective, especially if the music contains a lot of variation and sudden chords.

The second display is more subtle. The pattern woven is much more intricate and changes more gradually. The patterns are very beautiful and seem to follow the mood of the music. This type of display is best suited to contemplative music.

The pattern is formed by marking a point on each axis which corresponds to each channel of the sound. Then every

point is joined up to every other point. This is repeated for each quadrant to give a pleasing symmetrical effect. Because the pattern is so complex, only two are displayed at any one time.

The final display is a rapid response display. Each quadrant of the screen is devoted to one channel. A triangle is drawn whose size and displacement from the centre are controlled by the sound-level on each channel.

Again, like the first procedure, the variable N% controls the number displayed at any one time.

In all the above procedures, the colour of the display has been chosen at random, as this seemed to give the most pleasing effect. But you could experiment with the choice of colour being made by the level on one of the channels.

I have found that, for a vigorous display, the patterns should be roughly predictable. I seem to get the greatest enjoyment from this when I can use my knowledge of the music to predict when the patterns will change.

I am more than pleased with the results given by the circuit. It has a very hypnotic effect – you could just stare at it all day. My wife made the point that it helps you listen to the music and gives

you a focal point to concentrate on.

School music teachers might find it stops a class getting restless and helps the children pick out individual instruments when listening to music.

Unfortunately I cannot tell you how it fares under actual party conditions for two reasons. Firstly, this is being written before Christmas, so there are not many about, but mainly because I never seem to be asked to any. It might be the soap. I must start using some!

*Next month we tell you how to cope with a slipped disc. Merry Christmas!*

**Full listing on Page 118**

## What the Beeb Body Building packs contain

*Upgrade your BBC Micro with these Beeb Body Building Packs.*

● **Packs 1 and 2:** Really use your User Port! These two packs let you safely and simply join your micro to the outside world. The best way to learn about interfacing.

● **Pack 3:** Give your BBC Micro real data-processing muscle by building yourself a dual cassette

system – the way Acorn said you couldn't.

● **Packs 4 and 5:** These packs allow you to control mains equipment in complete electrical isolation from your micro – the only safe way to do it. Pack 4 is rated at 4 amps, pack 5 at 10 amps.

● **Pack 6:** All the electronic components you'll need to

construct the Micro User light pen, with its special screen-sensing circuit.

● **Pack 7:** Two interesting experiments that should appeal both to schools and the amateur scientist: investigate the behaviour of a pendulum and study capacitor discharge.

● **Pack 8:** Construct this versatile sound to pattern converter. Its many applications include running

a light show with your BBC Micro. It will also make the micro a resident fixture in many music classes.

Also available are a fully-assembled light pen and sound-to-pattern converter. For a small extra charge constructors who run into difficulty assembling pack 8 can send it in for testing. It will be returned fully operational.

**YOUR ORDER FORM**

for the Beeb Body Building packs

Please send me:	Described in issue	No.	Amount
Pack 1 @ £9.95	July 1983 page 83	<input type="checkbox"/>	£ .....
Pack 2 @ £9.95	July 1983 page 83	<input type="checkbox"/>	£ .....
Pack 3 @ £9.95	August 1983 page 85	<input type="checkbox"/>	£ .....
Pack 4 @ £9.95	Sept 1983 page 91	<input type="checkbox"/>	£ .....
Pack 5 @ £12.95	Sept 1983 page 91	<input type="checkbox"/>	£ .....
Pack 6 @ £13.65	October 1983 page 69	<input type="checkbox"/>	£ .....
Pack 7 @ £15.50	November 1983 page 71	<input type="checkbox"/>	£ .....
Pack 8 @ £16.55	December 1983 page 95	<input type="checkbox"/>	£ .....

Assembled light pen @ £18.35	October 1983 page 69	<input type="checkbox"/>	£ .....
Assembled sound to pattern converter @ £22.30		<input type="checkbox"/>	£ .....
Testing sound to pattern converter @ £9.70		<input type="checkbox"/>	£ .....

Plus post and packing £1.00 \*

\*Postage and packing FREE if more than one pack is ordered

All prices include VAT

Total £ .....

Name .....

Address .....

POST TO: BBC Packs, Micro User, Europa House, 68 Chester Road, Hazel Grove, Stockport SK7 5NY.

Please allow up to 28 days for delivery



# THE MICRO USER

A subscription will ensure you get your own personal copy **HOT OFF THE PRESSES** month after month for the next year.

# Be one of the first to get each issue!

Every owner of a BBC Micro – and everyone thinking of buying one – needs to get Micro User every month. It's the biggest, brightest, most authoritative yet completely independent guide to a machine that has so much potential you will never tire of reading about its remarkable capabilities.

You can buy Micro User from your local newsagent or station bookstall. Or you can take out a 12 months subscription and have it delivered by post.

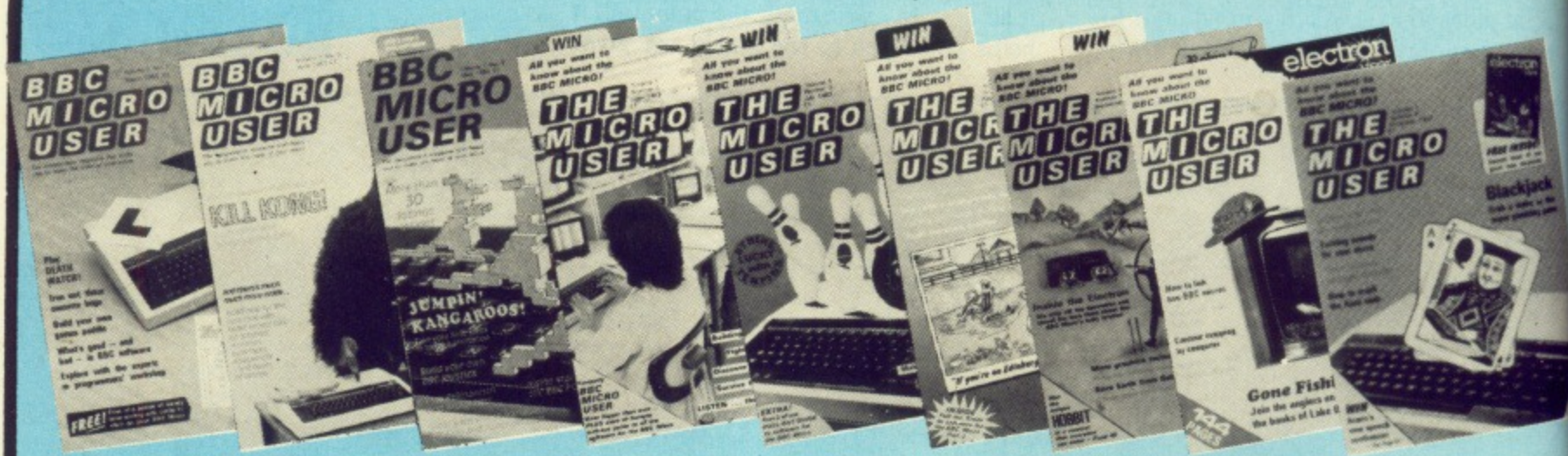

Copies of these back issues are still available at £1.25



Cassette tapes of Micro User programs – £3.75

Or take out a year's subscription and have your cassette posted to you each month. You can start your subscription from any issue to take advantage of this offer.



**FREE**

**COMPLETE THIS COUPON TODAY**



If you take out a subscription to *Micro User* you will receive completely free the sturdy copy-holder illustrated above, together with a large crib card containing essential information and charts that will save you continually referring to the User Guide. This free gift is for a limited period, so subscribe now!

**Your BBC Micro needs protecting!**



**£3.25**  
Standard  
(beige)

**£3.95**  
Deluxe  
(clear)

Keep your collection of *Micro User* complete with these handsome binders

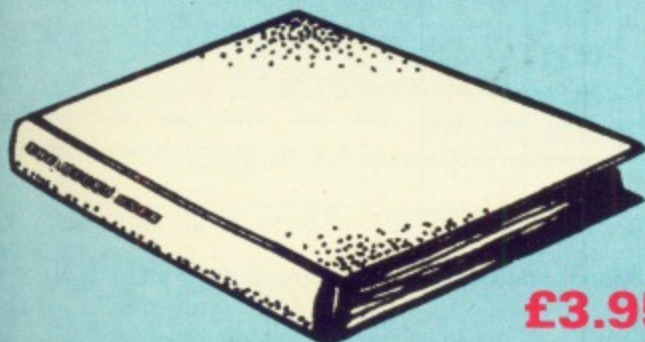

**£3.95**  
(UK)

**ORDER FORM**

All prices include postage, packing and VAT, and are valid to December 31, 1983

Please enter number required in box £ p

**Micro User** UK £12   
**annual subscription** EIRE £13 (IR £16)   
 Surface mail - Rest of world £18   
 Air mail - Rest of world £30

Commence with ..... issue TOTAL \_\_\_\_\_

**Micro User back issues**

<input type="checkbox"/>	£1.25 UK	March 1983	<input type="checkbox"/>
<input type="checkbox"/>	Rest of world:	April 1983	<input type="checkbox"/>
<input type="checkbox"/>	£1.50 - Surface	May 1983	<input type="checkbox"/>
<input type="checkbox"/>	£2.50 - Air mail	June 1983	<input type="checkbox"/>
		July 1983	<input type="checkbox"/>
		Aug 1983	<input type="checkbox"/>
		Sept 1983	<input type="checkbox"/>
		Oct 1983	<input type="checkbox"/>
		Nov 1983	<input type="checkbox"/>

TOTAL \_\_\_\_\_

**Cassette tape annual subscription**  
**£40** (UK & Overseas)

Commence with ..... tape (state month) TOTAL \_\_\_\_\_

**Cassette tape single copies** £3.75 (UK & Overseas)

<input type="checkbox"/>	Deathwatch	March 1983	<input type="checkbox"/>
<input type="checkbox"/>	King Kong	April 1983	<input type="checkbox"/>
<input type="checkbox"/>	Air Strike	May 1983	<input type="checkbox"/>
<input type="checkbox"/>	Space Pilot	June 1983	<input type="checkbox"/>
<input type="checkbox"/>	Tenpin	July 1983	<input type="checkbox"/>
<input type="checkbox"/>	Fruities	Aug 1983	<input type="checkbox"/>
<input type="checkbox"/>	Robin & Marian	Sept 1983	<input type="checkbox"/>
<input type="checkbox"/>	Gone Fishin'	Oct 1983	<input type="checkbox"/>
<input type="checkbox"/>	Blackjack & Goblins	Nov 1983	<input type="checkbox"/>
<input type="checkbox"/>	Tower Bridge	Dec 1983	<input type="checkbox"/>

TOTAL \_\_\_\_\_

**Dust Covers**  
 £3.25 - Standard   
 £3.95 - Deluxe   
 (UK & Overseas) TOTAL \_\_\_\_\_

**Binders**  
 £3.95 - UK   
 £5.00 - Overseas   
 TOTAL \_\_\_\_\_

Payment: please indicate method (✓), TOTAL \_\_\_\_\_

Access/Mastercharge/Eurocard  
 Barclaycard/Visa  
 American Express  
 Card No. \_\_\_\_\_  
 Expiry Date \_\_\_\_\_  
 Cheque/PO made payable to Database Publications Ltd.



Name \_\_\_\_\_

Address \_\_\_\_\_

Signed \_\_\_\_\_

Send to: **Micro User, FREEPOST, Europa House, 68 Chester Road, Hazel Grove, Stockport SK7 5NY.**

(No stamp needed if posted in UK)

**You can also order by phone or Prestel**

Any of the goods listed here can be ordered by telephone. Micronet subscribers and other users of Prestel can also use the Prestel Mailbox.

Telephone  
**061-480 0171**  
 9am - 5pm

Prestel Mailbox  
**614568383**  
 24 hours

Don't forget to quote your credit card number.





# OPTIMA SOFTWARE



**Atomic Protector**  
As a robot at a secret research establishment you are left in charge of the uranium deposits — your only means of life support. You have to defend the isotopes from the ruthless attacks of hostile infiltrators.  
To add to your troubles, one by one the intruders begin to achieve critical mass — you must catch and deal with each as soon as possible if you're to survive.

£8.95

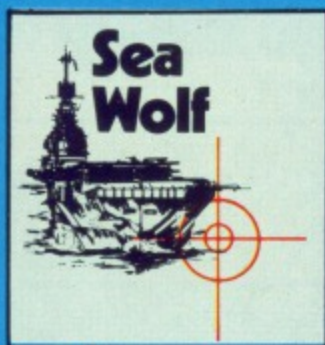

**Sea Wolf**  
So far all has gone well. You have successfully guided your submarine safely through enemy controlled waters and you are beginning to relax.  
Suddenly alarm bells scream in your ears — you are under attack! Desperately you scan the radar screen. Should you try to get him within range of your torpedoes, or attempt evasive tactics? Can you lead your crew to safety?

£8.95

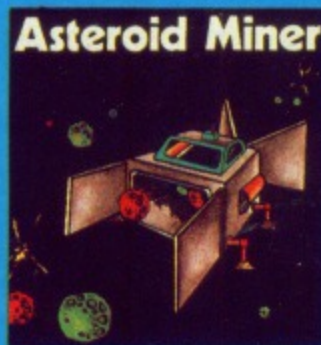

**Asteroid Miner**  
A truly original all-action machine code game that will test you to the limit.  
As you battle to harvest precious metal from the asteroid swarm, you have to combat an unscrupulous rival who stops at nothing.  
Can you gather enough asteroids to survive? Are you skilful enough to avoid your opponent's neutron mines?

£8.95



**Datext**  
A high-powered, easy to use teletext editing and library program.  
With Datext you can create colourful teletext pages simply and speedily, storing them for later recall.  
Uses for this versatile utility include shop window displays, school newspapers, personalised story books for children, and many more.

£9.95



**Optimon**  
A full machine code monitor, designed to help the average programmer.  
Its many features include two modes of memory dump, full disassembler with OS calls labelled, intelligent block memory moves, a speedy string and hex byte search.  
Beginners will find Optimon's ability to display the opcodes for all 6502 mnemonics invaluable.

£9.95

# Software. With a touch of brilliance

Please send the following cassettes, BBC Model B version.

Qty.		Price (incl. VAT)	Amount
	Atomic Protector	£8.95	
	Sea Wolf	£8.95	
	Asteroid Miner	£8.95	
	Datext	£9.95	
	Optimon	£9.95	

Add 50p for post and packaging  
(post free for 2 or more)

TOTAL:

Name .....

Address .....

.....

.....

.....

.....

I enclose cheque made payable to Optima Software Ltd.

I wish to pay by No.....

Access  Visa Expiry date .....

Optima Software Ltd., 36 St. Petersgate, Stockport SK1 1HL.





# Add on the printer that adds up to less than £230

A Seikosha GP100A Printer. Plus the correct interface\*, cable and software for either a Spectrum or BBC Micro. All at a price that adds up to just £229.95 inc. VAT.

For a superb combination of economy and reliability, this package is unbeatable.

### Full graphics capability

The Seikosha GP100A uses standard width paper, and prints in an 80 column dot matrix format. Printing speed is 50 characters a second (180 x 7 dots/sec).

The GP100A comes with a full graphics capability.

### Apply immediately

You can buy the Seikosha GP100A Printer at any of our dealers throughout the country. For the address of the one nearest you, phone this number without delay:

**0934 419914**

\*Centronics parallel interface is supplied as standard, unless serial RS232 is required for use with Sinclair Microdrive. Please specify.

**DRG**  
**BUSINESS**  
**MACHINES**

DRG Business Machines. Unit 13/14 Lynx Crescent, Winterstoke Road, Weston-super-Mare, BS24 9DN

Please send me further details of the Seikosha GP100A Printer, and the name of my nearest stockist.

I am particularly interested in Spectrum  BBC Micro

Name \_\_\_\_\_

Address \_\_\_\_\_





# KIRKLANDS COMPUTERS

OFFICIAL ACORN DEALER

Kirklands House, 27 City Road, Stoke-on-Trent. Tel: 0782 415787

## BBC MICROCOMPUTER

	Incl. VAT
Model B .....	£399
Model B & Disc Interface .....	£469
Model B & Econet .....	£446
Model B & Econet & Disc Int. ....	£516
Disc Interface Kit .....	£97
* Speech Synthesizer (Official BBC) .....	£54
Torch Disc pack .....	£943
Teletext Receiver .....	£225
Upgrade Kit .....	£50
BBC 16K Memory .....	£18.50
BBC Print User input/output port .....	£8
BBC Analogue Kit .....	£7.30
BBC Serial .....	£7.80
BBC Expansion Basket .....	£7
1.2 Operating System (incl. fitting) .....	£11.50
* (New in stock price incl. fitting)	
Fitting services available.	

## MONITORS

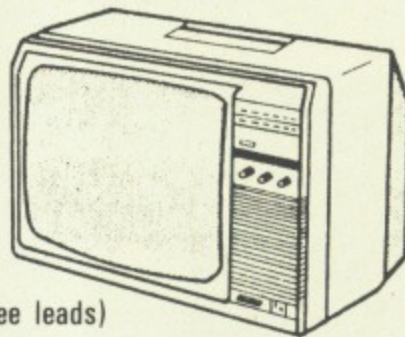

(Inclusive of free leads)

	Incl. VAT
Microvitec 14" Colour .....	£287
Sanyo 14" Colour L-R .....	£225
Sanyo 14" Colour M-R .....	£285
14" TV/Monitor Colour .....	£289
Kaga 12" Colour .....	£304
Sanyo 12" Green L-R .....	£79
Sanyo 12" Green M-R .....	£95
Sanyo 12" Green H-R .....	£126

## electron



**ON SALE NOW!**  
**£199.00** (including VAT)

## DISC DRIVES

	Incl. VAT
<b>Single Drives Cased</b>	
<b>Single Drives 5 1/4"</b>	
100K-40 Track .....	£195
200K-40 Track Double Sided .....	£265
200K-80 Track .....	£265
400K-80 Track Double Sided .....	£345
<b>Dual Drives 5 1/4"</b>	
200K-80 Track .....	£350
400K-40 Track Double Sided or 80 Track .....	£430
800K-80 Double Sided .....	£595
Power Supply .....	£40
40/80 Switch .....	£12
(All cased with free cables, manuals and formatting disc).	
<b>Floppy Discs in packs of 10</b>	
Single Sided 40 Track .....	£22
Double Sided 80 Track .....	£36

## SOFTWARE

DESIGNED FOR THE BBC MICROCOMPUTER

GAMES	
Monsters .....	£9.95
Snapper .....	£9.95
Planetoid .....	£9.95
Arcade Action .....	£11.90
Rocket Raid .....	£9.95
Meteors .....	£9.95
Arcadians .....	£9.95
Sliding-Block Puzzle .....	£9.95
Cube Master .....	£9.95
Starship Command .....	£9.95
Snooker .....	£9.95
Super Invades .....	£9.95
Hopper .....	£9.95
Colditz .....	£9.95



FOR THE BBC "B"  
 AND ELECTRON

Pass Go .....	£8.50 (BBC only)
Devils Causeway .....	£8.50 (BBC Electron)
Connect 4 .....	£7.50 (BBC & Electron)
Star Maze II .....	£8.50 (BBC & Electron)

Dealers note that the above software is stocked by Callisto Computers and Lightning Records.

MISCELLANEOUS	INCL. VAT
Sanyo DR101 Data Recorder .....	44.95
Cassette leads - all types .....	2.80
Acorn Joysticks .....	13.00
Quickshot Joystick (BBC) .....	19.95
Printer Cable (Parallel) 1.2 m .....	13.00
BBC Deluxe cover .....	5.95
Light Pen .....	39.95
Data Cassettes 5 x C20 .....	1.95
ROM SOFTWARE	
Wordwise .....	39.95
View .....	59.00
Beebcalc .....	39.00
Disc Doctor .....	32.95
Termi (terminal emulator) .....	32.95
LVL Double Density Upgrade .....	89.95
ROM Expansion Board .....	43.75
System Spy .....	23.95
BOOKS	
30 Hour Basic .....	5.95
ALP for BBC Micro .....	8.95
BBC Revealed .....	7.95
Let your BBC micro teach you to program .....	6.45
Basic Programming on the BBC Micro .....	5.95
Creative Graphics .....	7.50
Graphs & Charts .....	7.50
Lisp Manual .....	7.50
Forth Manual .....	7.50
BCPL Manual .....	15.00
35 Educational Programs .....	6.95
30 Programs for BBC .....	4.95
Further Programs .....	5.95
100 Programs for the BBC Micro .....	6.95
Discovering BBC Machine Code .....	6.95
Easy Programming for the BBC Micro .....	5.95
21 Games for the BBC .....	5.95
BBC Disk Manual .....	1.95
The Book of Listings .....	3.75
The BBC Micro an Expert Guide .....	6.95
Introducing the BBC Micro .....	5.95
The Computer Book .....	6.75
Programming the BBC Micro .....	6.50
Further Programming the BBC Micro .....	5.95
Using Floppy Disks with the BBC Micro .....	9.95
Creating Adventure Programs on the BBC .....	6.95
Games BBC Computers Play .....	6.95

WE ACCEPT INSTITUTIONAL EDUCATIONAL ORDERS

PRINTERS	INCL. VAT
Epson RX80 .....	308.00
Epson RX80FT *NEW .....	366.85
Epson FX80 .....	399.00
Epson FX100 *NEW .....	569.00
NEC PC8023 .....	348.00

See us at the

## BBC MICRO USER SHOW

Westminster  
 Exhibition  
 Centre • London

December 8-11

### MAIL ORDER

Post your order today to:  
 Kirklands Computers. Or telephone  
 your Access or Barclaycard number,  
 we will despatch immediately  
 (0782) 415787.

Call in today. Home Computer Centre  
 for the BBC enthusiast.  
 Send large SAE for further details of  
 any product.

CARRIAGE    
 Micro's Monitors, Disc Drives,  
 Printers £8.00, Books £1 each.  
 Cassette Decks £2.00, Leads and  
 software  
 50p/item, £1.50 max.



MANY newcomers to micro-computing are somewhat puzzled by the fact that seemingly straightforward words and phrases take on a completely different meaning when used in a computing context. Here is a list, by no means comprehensive, that should allow the computer neophyte to make some sense of the new Computerspeak.

# An innocent's guide to Computerspeak

*"The applications of this are only limited by your own imagination"* - I can't think of anything useful it can do.

*"Compatible with any computer"* - Will not work with your computer unless you know more about interfacing than we do.

*"Standard"* - We don't know enough about other computers to know why it won't work with yours.

*"Universal standard"* - We have actually tried it out on one other computer.

*"Industry standard"* - We have copied the design from someone else who says it works.

*"Delivery will be in three weeks"* - This is known as Holbein's constant as, whenever you ask the question, delivery will always be in three weeks.

*"Delivery will be at the end of the month"* - Another example of Holbein's constant, for the innumerate.

*"In stock"* - We have ordered it from the manufacturer.

*"Now in stock"* - When the closing date for advertisements was reached four weeks ago, we were promised delivery in three weeks.

*"Obsolete"* - A word to describe something actually in stock.

*"Will be available shortly"* - We haven't actually designed it yet but can foresee no difficulty.

*"Will be available early next year"* - We found the difficulty.

*"Operating system"* - Something that we sell you every six months or whenever you find out the last one doesn't actually work properly.

*"This program can easily be modified to run on other popular computers"* - Sometimes seen at the end of software articles and is a disclaimer for any in-

telligence the author might have falsely indicated to the reader.

*"Programs may be saved on any domestic tape recorder"* - This is any recorder except the one you actually own at the moment.

*"Using your TV as a display"* - Sometimes you may be able to actually read what is on the display as well.

*"Can be easily expanded"* - You have a bargain with what you have now but we will rip you off if you want to make it actually useful.

*"User friendly"* - You are asked for every little option and parameter to see if it needs to be included. This usually takes about ten minutes. In addition you have to go through the whole lot again if you want to change just one thing.



# 3D COMPUTERS

THE HOME COMPUTER  
SPECIALISTS

WITH MORE BRANCHES THAN ANY  
OTHER ACORN DEALER WE OFFER

## ONE-STOP SHOPPING

FOR YOUR

**BBC MICRO**

AND

**ELECTRON**

CALL IN AT YOUR LOCAL BRANCH  
FOR FRIENDLY ADVICE AND  
SERVICE.

SEE A COMPLETE DISPLAY OF  
HARDWARE & SOFTWARE TO BUILD  
UP YOUR ACORN MICRO SYSTEM

**SOFTWARE**  
PROGRAM POWER  
BUG-BYTE  
SUPERIOR SOFTWARE  
A & F  
SIMON HESSEL  
MOLIMERX  
ALLIGATA  
ACORNSOFT

**PERIPHERALS**  
DISCS SINGLE/DUAL  
TORCH Z80 DISCS  
CUMANA DISCS  
PRINTERS  
JOYSTICKS  
MONITORS  
B & W/COLOUR  
LIGHT PENS  
BBC BUGGY

Large range of books,  
diskettes, cassettes and  
printer paper always in  
stock.

Easy Parking at all branches

**TOLWORTH**  
230 Tolworth Rise South,  
Tolworth, Surbiton  
Surrey KT5 9NB  
Tel: 01-337 4317

**SUTTON**  
30 Station Road,  
Belmont, Sutton,  
Surrey SM2 6BS  
Tel: 01-642 2534

**EALING**  
114 Gunnersbury Avenue,  
Ealing, London W5 4HB  
Tel: 01-992 5855

**LUTON**  
1 Manor Road,  
Caddington,  
Luton, Beds LU1 4EE  
Tel: (0582) 767104

**MILTON KEYNES**  
Unit 1, Heathfield,  
Stacey Bushes,  
Milton Keynes MK12 6HP  
Tel: (0908) 317832

**NEWBURY**  
26 Stanley Road,  
Newbury,  
Berks RG14 7PB  
Tel: (0635) 30047

# FREE!

Acorn Joysticks with each G.T. ordered.  
MICRO-DRAW fully cased G.T. with 8 drawing  
programs for B.B.C. Model B

**£175 + £11 p&p + VAT**  
Delivered by SECURICOR

Data sheet available by sending S.A.E. to address below or  
PHONE (0622) 59778

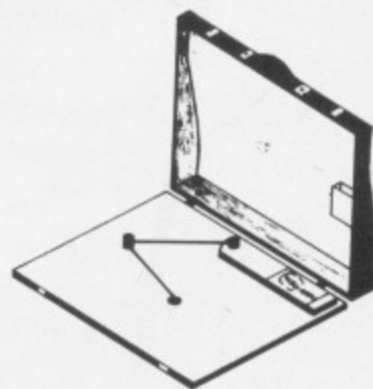

### PRINTERS

Epson RX-80-FT	£309
Epson FX-80 (160 CUPS)	£425
Epson RX-80 (100 CUPS)	£270
Epson MX 82T	£360
Epson MX100FT-3	£460
OKI M80A	£220
OKI M82A	£318
OKI M935	£750
Seikosha GP-100A	£210
Seikosha GP-250X	£242
Seikosha GP 700A (colour)	£410
Brother HR1	£615
Brother HR15	£400
Please add £7.00 P&P + VAT.	

Cables supplied at no extra  
cost with above printers.

### PRINTER ACCESSORIES

Epson Buffers MBS 16K RS232	£150
Epson Buffers MBS 32K RS232	£170
Epson Buffers MBS 32K Parallel	£155
Epson Buffers MBS 64K Parallel	£225
Epson Print Heads	£35
Epson Paper Roll Holder	£18
Epson Tractor FX	£34
Epson Fingerprint	£45
Please add £3.00 P&P + VAT.	

### MONITORS

Kaga RGB Vision I	£239
Kaga RGB Vision II	£285
Kaga RGB Vision III	£399
Kaga Green Screen	£99
Kaga Amber Screen	£113
Phoenix Green	£85
Phoenix Amber	£90
Luxor RGB	£520
Please add £11.00 P&P + VAT.	

Cables supplied for above  
monitors £8 + VAT.

### DISC DRIVES

Pace Single Sided Drive (40 track) 100K	£185
Pace Double Sided Drive (40 track) 200K	£235
Pace 40/80 Switchable Drive 400K	£345
Pace Dual Single Sided Drives (40 track) 200K	£338
Pace Dual Double Sided Drives (40 track) 400K	£449
Please add £4.00 P&P + VAT.	

### DISC ACCESSORIES

Pace Disc Interface Kit	£82.60
Pace Toolmaster ROM	£29.50
Pace 80 to 40/80 Track Converter	£25.00
BASF SS/SD	£24.00
BASF SS/DD	£32.00
BASF DS/DD	£33.00
BASF SS/96 TPI	£35.00
BASF DS/96 TPI	£40.00
Please add £2.50 P&P + VAT.	

**MICRO-DRAW Ltd.**  
48 Hedley Street  
Maidstone  
Kent ME14 5AD





# BBC MICRO IN CAMBRIDGE

Our product range and knowledge of the system are unequalled—you'd expect that in Cambridge, wouldn't you!

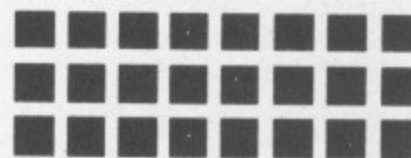

**Cambridge Computer Store**

1 Emmanuel Street  
Cambridge CB1 1NE  
Telephone (0223) 358264  
(closed 12.30 — 1.15 except Saturday)



## DO YOU WANT A WORD PROCESSOR FOR YOUR BBC OR A WORD PROCESSOR FOR YOUR BBC ?

Yes there is a difference between word processors and we can offer the best because it's the **FIRST PROFESSIONAL DISC BASED WORD PROCESSOR FOR THE BBC COMPUTER.**

The MERLIN SCRIBE uses the disc on your computer the same way that professional systems costing many hundreds of pounds do.

Until now any document you wished to create has been limited to the few pages which could be squeezed into your computer memory. This means the computer is really using the disc as if it were a cassette!

The SCRIBE can create documents far greater in size than the computer memory, and really uses the disc as it was intended to be used. SCRIBE automatically loads and offloads pages between disc and memory without you even knowing it's happening!

Amongst the many super features available are:

- \* Optional 40 & 80 column screen format selection.
- \* On screen formatting - you see it as it's printed **INCLUDING UNDERLINING.**
- \* Right justify, word wrap, insert, delete, move copy & centre.
- \* Document merge (will merge two documents into one from disc).
- \* Addresses all four drive units allowed by your BBC disc system.

Plus many more professional features.

SCRIBE comes in ROM with five minute fitting instructions, printer utilities on disc and a comprehensive manual.

PRICE £59.95

Also MERLIN SCRIBE in ROM for cassette machines £29.95, and on tape £19.95. All prices include VAT. Post and Packaging 60p.

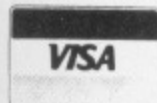

MERLIN COMPUTER PRODUCTS (BUCON LIMITED)  
18 MANSEL STREET, SWANSEA, SA1 5SG. TEL (0792) 467980





# SMART MODEM!

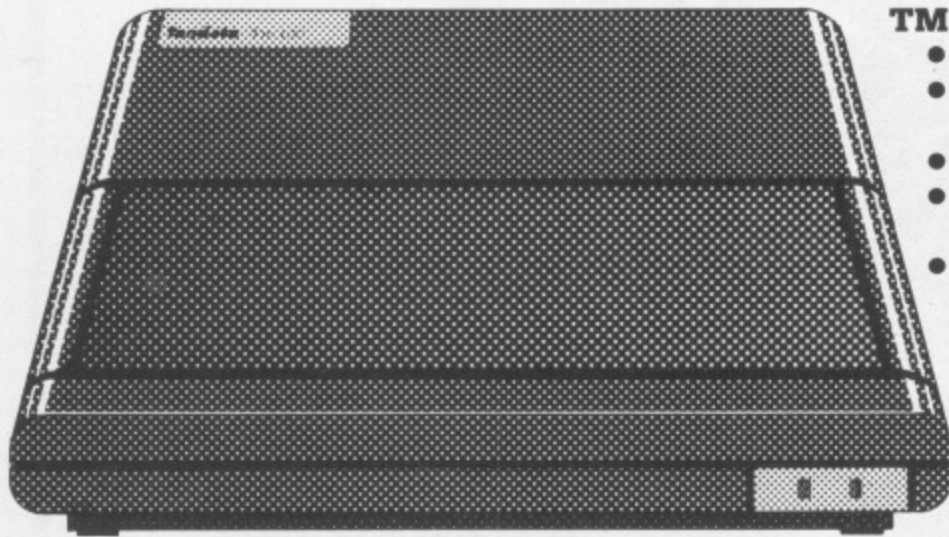

## TM 100 AVAILABLE NOW:

- 1200/75 bps (Prestel, Telecom Gold etc.)
- 8 telephone nos & 8 ID's stored in modem
- auto-dial and auto-retry
- RS 232 interface to micro, 1200bps duplex
- telephone cable with new 600 series connector

## TM 200 AVAILABLE SOON:

- has all features of Tm 100
- multi-rate 300/300 and 1200/75
- allows direct communication in "chat" mode

Tandata Marketing Ltd  
Ref: MU/10/83  
Albert Road North  
Malvern, Worcs.

## SOFTWARE

- terminal, Prestel and downloader software for BBC, Apple
- apply for details of other micros

FROM  
**£99**

# Tandata

Available as a card or boxed for OEMs  
Prestel is a registered Trade Mark of British Telecom

## THE REAL AMCOM DISC FILING SYSTEM

One of its distinct advantages against the Acorn DFS is the speed in which it handles Random Access Files (refer Benchmark figures), consequently, it can load wordwise files in approximately half the time taken by the Acorn DFS.

PRINT 1000 numbers	9.8	Move PTR 1000 places	2.9
PRINT 100 strings	56.2	Write test relative file	51.0
INPUT 1000 numbers	5.7	Read test relative file	24.2
INPUT 100 strings	22.7	Write relative file backwards	81.0
BPUT 1000 bytes	4.5	Read relative file backwards	36.0
BGET 1000 bytes	3.4		

This independent disc filing system adds greater flexibility to your BBC Computer. It has two distinct modes which auto select on booting the system. Mode zero is the standard mode which retains compatibility with presently available software. Mode one, the extended mode, allows for sixty-three file names per disc, over 100% increase on the existing DFS, and also permits the file names to be up to fifteen characters in length, providing much greater scope for meaningful file names. In both modes page is set at &1500. This gives 10% more usable memory than Acorn's DFS, in modes 0, 1 and 2. If you already have a Disc interface fitted, it is very easy to upgrade, you simply remove the DFS Eprom and replace it with the Amcom DFS Eprom, if not then it is possible to purchase an entire Disc interface kit (consists of 11 I.C.'s) with this DFS track cutting is not required. Also includes 8 way DIL switch to allow start up options to be set. (see below).

Link 1 Determines if the system starts up in 40 or 80 tracks

Link 2 Select Acorn or Extended mode at start-up

Link 3 & 4 Selects type of drive ie. Shugart, Canon etc.

Link 5 Select auto-boot or not, on 'break'

Link 6-8 Select screen mode on start-up, ie. model 0 to 7 etc.

### NINE NEW COMMANDS ARE NOW AVAILABLE

- \*Clear Quickly and easily erases a entire disc
- \*Format Formats drive 0 to 3 in either 40 or 80 tracks
- \*OPT2,n Alters the number of sectors per track to n
- \*OPT3,n Alters the number of tracks per disc to n
- \*OPT5,n Sets the start of the DFS buffer (see OPT7)

- \*OPT6,n Provides control over which part of the file spec. will be displayed ie. only display directory and program length, or just display drive and load address.
  - \*OPT7,n Sets the length of the DFS buffer
  - \*OPT8,n Double steps the disc drive to allow the reading of 40 track discs on 80 track drives
  - \*SYS Selects either Acorn mode or Extended mode
- Commands now include \*Access

There is a built-in formatter which will format in either forty or eighty tracks in both modes of operation. This formatter also allows for user definable parameters to be included for the development of software protection. With this disc filing system a user definable buffer can be used while compacting the disc. This will enable disc compacting to be carried out without overwriting any programme in memory. Alternatively a new disc may be formatted without any resident programme being overwritten.

This DFS also allows for the use of wildcard characters, using either the † symbol for a single wildcard and the \* character for multiple wild characters. (e.g. CHAIN "P\*" could be used to chain a program called PRINTER as long as there are no other files whose names begin with P).

This DFS is totally compatible with Econet etc., and is complete with a utilities disc and comprehensive manual. The utilities disc contains many useful programmes including printer screen dumps in all modes, including High Res. (Epson & NEC 8023). It also has a nibble editor to scan discs, read data, edit them, and then write back to the disc. Plus a utility to assist in the transfer of cassette files to disc.

Available now direct from Pace or contact your local dealer.

Comes complete with disc, 8 way DIL switch, manual and full fitting instructions at £34 inclusive of VAT.

Also available as a complete Disc Interface Kit (including DFS) at £95 inclusive of VAT.

PACE SOFTWARE SUPPLIES LTD., 92 NEW CROSS STREET, BRADFORD BD5 8BS.



0274 729306





## Graphics listing

From Page 47

### Program VII

```

10 REM *** PROGRAM VII ***
20 MODE 1
30 VDU23;11,0;0;0;0
40 PROCinit
50 PROCtriangles
60 PROCbase
70 PROCcandles
80 PROCballs
90 PROCfairy
100 PROCmessage
110 END
120 REM =====
130 DEF PROCinit
140 VDU 19,3,2,0,0,0
150 VDU 19,0,4,0,0,0
160 centre%=640
170 REPEAT
180 READ vdu%
190 IF vdu%(<)-1 THEN VDU vdu%
200 UNTIL vdu%=-1
210 candle$=CHR$(18)+CHR$(0)+CHR$(1)
+CHR$(224)+CHR$(10)+CHR$(8)+CHR$(225)
+CHR$(8)+CHR$(10)+CHR$(225)+CHR$(18)+C
HR$(0)+CHR$(2)+CHR$(11)+CHR$(11)+CHR$(
8)+CHR$(226)
220 REM Unfilled ball
230 uball$=CHR$(227)+CHR$(228)+CHR$(
10)+CHR$(8)+CHR$(8)+CHR$(229)+CHR$(230
)
240 REM Filled ball
250 fball$=CHR$(231)+CHR$(232)+CHR$(
10)+CHR$(8)+CHR$(8)+CHR$(233)+CHR$(234
)
260 REM Fairy
270 fairy$=CHR$(18)+CHR$(0)+CHR$(1)+
CHR$(235)+CHR$(236)+CHR$(237)+CHR$(10)
+CHR$(8)+CHR$(8)+CHR$(8)+CHR$(238)+CHR
$(239)+CHR$(240)+CHR$(10)+CHR$(8)+CHR$(
8)+CHR$(8)+CHR$(241)+CHR$(242)+CHR$(2
43)
280 REM Fairy with wings
290 wfairy$=CHR$(18)+CHR$(0)+CHR$(2)
+CHR$(244)+CHR$(245)+CHR$(246)+CHR$(10)
+CHR$(8)+CHR$(8)+CHR$(8)+CHR$(247)+CH
R$(248)+CHR$(249)+CHR$(10)+CHR$(8)+CHR
$(8)+CHR$(8)+CHR$(250)+CHR$(251)+CHR$(
252)
300 ENDPROC
310 REM =====
320 DEF PROCtriangles
330 GCOLOR,3
340 FOR counter%=1 TO 3
350 READ top%,offset%,bottom%
360 MOVE centre%,top%:MOVEcentre%-of
fset%,bottom%
370 PLOT 85,centre%+offset%,bottom%
380 NEXT counter%

```

```

390 ENDPROC
400 REM =====
410 DEF PROCbase
420 GCOLOR,1
430 READ offset%,height%
440 MOVE centre%+offset%,96:MOVE cen
tre%-offset%,96
450 PLOT 85,centre%+offset%,height%
460 PLOT 85,centre%-offset%,height%
470 ENDPROC
480 REM =====
490 DEF PROCcandles
500 VDU 5
510 FOR counter%=1 TO 6
520 READ xpos%,ypos%
530 MOVE xpos%,ypos%
540 PRINT candle$
550 NEXT counter%
560 VDU 4
570 ENDPROC
580 REM =====
590 DEF PROCballs
600 VDU 5
610 FOR counter%=1 TO 6
620 READ xpos%,ypos%,outer%,inner%
630 GCOLOR,inner%:MOVE xpos%,ypos%
640 PRINT fball$
650 GCOLOR,outer%:MOVE xpos%,ypos%
660 PRINT uball$
670 NEXT
680 VDU 4
690 ENDPROC
700 REM =====
710 DEF PROCfairy
720 MOVE 596,1000
730 VDU 5
740 PRINT wfairy$
750 MOVE 596,1000
760 PRINT fairy$
770 VDU 4
780 ENDPROC
790 REM =====
800 DEF PROCmessage
810 VDU 5
820 GCOLOR,2
830 FOR counter%=0 TO 16STEP 4
840 MOVE 64-counter%,68-counter%
850 PRINT "MERRY CHRISTMAS AND A HAP
PY NEW YEAR"
860 NEXT counter%
870 MOVE 64-counter%,68-counter%
880 GCOLOR,1
890 PRINT "MERRY CHRISTMAS AND A HAP
PY NEW YEAR"
900 VDU 4
910 ENDPROC
920 REM =====
930 REM Candle
940 DATA 23,224,16,56,56,124,124,56,

```

```

16,56,23,225,56,56,56,56,56,56,56
950 DATA 23,226,16,56,56,124,124,56,
16,0,23,255,16,56,56,124,124,56,0,0
960 REM Unfilled Ball
970 DATA 23,227,1,1,14,56,32,64,128,
128,23,228,128,128,112,28,4,2,1,1,23,2
29,128,128,64,64,32,24,7,0,23,230,1,1,
3,2,4,24,224,0
980 REM Filled Ball
990 DATA 23,231,1,1,15,63,63,127,255
,255,23,232,128,128,240,252,252,254,25
5,255,23,233,255,255,127,127,63,31,7,0
,23,234,255,255,255,254,252,248,224,0
1000 REM Fairy
1010 DATA 23,235,0,0,0,0,0,0,0,0,23,2
36,0,0,0,56,124,124,124,56,23,237,0,0,
0,0,0,0,0,23,238,0,0,1,3,7,0,0,0,23,
239,124,254,255,125,125,124,254,254
1020 DATA 23,240,0,0,0,128,192,0,0,0,
23,241,1,1,3,3,7,0,0,0,23,242,255,255,
255,255,255,0,0,0,23,243,0,0,128,128,1
92,0,0,0
1030 REM Fairy plus Wings
1040 DATA 23,244,0,32,48,56,60,60,62,
63,23,245,0,0,0,56,124,124,124,57,23,2
46,0,8,24,56,120,120,248,248,23,247,63
,63,63,63,63,62,60
1050 DATA 23,248,255,255,255,255,255,
255,254,126,23,249,248,248,248,248,248
,248,248,120,23,250,61,57,51,35,7,0,0,
0,23,251,255,255,255,255,255,0,0,0,23,
252,120,56,152,136,192,0,0,0
1060 DATA -1
1070 REM Triangles Data
1080 DATA 950,175,775,850,300,550,675
,400,300
1090 REM Base Data
1100 DATA 50,296
1110 REM Candle Positions
1120 DATA 460,871,805,871,335,646,930
,646,235,396,1030,396
1130 REM Ball Positions
1140 DATA 400,400,2,1,800,450,1,2,700
,650,0,1,600,500,1,0,450,625,0,2,575,7
50,2,0

```

### Program VIII

```

10 REM *** PROGRAM VIII ***
20 MODE1
30 GCOLOR,2
40 VDU 5
50 FOR I%=0 TO 12 STEP 4
60 MOVE 544-I%,512-I%
70 PRINT "A WORD"
80 NEXT I%
90 MOVE 544-I%,512-I%
100 GCOLOR 0,1
110 PRINT "A WORD"
120 VDU 4

```



# Silverlind

SILVERLIND LTD. 156 Newton Road, Burton-on-Trent, Staffs. DE15 0TR. Tel Burton (0283) 63987

## STRATEGY GAMES

**PENTILES** BBC/B £6.95  
An original and addictive game for all ages from 8 to 80 requiring skill, memory, logic - and luck!

**REVERSI** BBC/B £6.95  
Play the computer in this fast BASIC/machine code version of the popular board game. 5 skill levels, auto-play, etc.

## ADVENTURE GAMES

**HAUNTED HOUSE** BBC/B £6.00  
An excellent introduction to adventure games. Can you survive the perils of the castle and the graveyard, to collect the 6 treasures AND rescue the princess?

**JOURNEY TO THE STARS** BBC/B £6.50  
You have been sent on a dangerous mission to find 10 treasures - but how are you going to get back? Beware of the Antiflavian MegaTiger and venomous lizard woman!

**PASSPORT TO DEATH** BBC/B £6.50  
From the planet Zandra, you have been sent to Earth, a strange place with stranger inhabitants! Finding treasures is not enough - without extra fuel, your starship will not get you home.

## EDUCATIONAL PROGRAMS

**ENJOY MATHS** 48K Spectrum £8.00  
A suite of 4 highly motivating programs for the 8 - 14 age range: tables, simple equations, polygons and areas. The programs combine explanation with tests and make good use of colour and sound.

**TOWNTTEST** BBC/B £6.50  
Identify the major towns and cities of England, Scotland and Wales, displayed on a high-resolution map. Suitable for all age groups and for school or home use (try it as a quiz for all the family!)

**BIOLOGY** BBC/B £12.50  
A major collection of programs, written by a GCE examiner, designed to aid the understanding of Biology to CSE, 'O' and 'A' Level standards. These programs - comprising text, animated diagrams and questions - are available in one package and are suitable for individual study at school or in the home. Teachers will also find material suitable for class demonstration.

ALL PRICES INCLUDE POST & PACKING & VAT

*We require good programs to increase our catalogue and pay high royalty rates for published material.*

# CHALKSOFT

37, Willowslea Road,  
Worcester WR3 7QT  
Telephone: 0905 55192

## EDUCATIONAL SOFTWARE

### SPECIAL CHRISTMAS OFFER

Offer  
closes  
JAN 31  
1984

Special thanks to

- \* Good computer shops everywhere
- \* Access \* Adtel ansaphones
- \* Webster and other imaginative software distributors
- \* Simon stables Real Time Tape Duplicating Company.



Take this coupon to your  
local dealer or post direct.

Buy two or more and get £1 off each.

TITLE	XMAS PRICE	MACHINE	TICK HERE
<b>PUNCMAN 1 &amp; 2</b> Animated punctuation game. Can you help Puncman beat Nosh...?(7-12 years)	£9.25	BBC 'B'	
	£8.25	Spec 48K	
<b>STORY A - SPANISH GOLD</b> The first multichoice illustrated story book on screen. (6-11 years)	£7.95	BBC 'B'	
	£6.95	Spec 48K	
<b>PIRATE</b> Simply the best adventure game for young people (7 to adult) illustrated. Compulsive.	£9.25	BBC 'B'	
	£8.25	Spec 48K	
<b>LETTERS</b> Let your micro teach your child to write! Draws lower-case letters ....	£11.25	BBC 'B'	
	£10.25	Spec 48K	
<b>INKOSI</b> Be an African King! Simulation. Can you look after the tribe and defeat the WITCH DOCTOR...?	£6.95	BBC 'B'	
	£5.95	Spec 48K	

To: Chalksoft Ltd.  
37, Willowslea Road,  
WORCESTER WR3 7QP

Please send me your new  
16 page colour catalogue \_\_\_\_\_

Please rush me the tapes I've ticked.

I enclose a cheque for £ \_\_\_\_\_  
or debit my Access no: \_\_\_\_\_

Name \_\_\_\_\_

Address \_\_\_\_\_

Postcode \_\_\_\_\_

Hey Dad! We use  
that at school ..!

A good  
idea for Xmas  
I'll send off  
today.



Tick at least two. Remember, if you  
only buy one you pay the old price.

Prices include VAT and p&p.



**MOUSE MAZE £4.95** Try for a high score before the cats get you. Eat power pills and chase the cats. Difficulty increases with each sheet.

**SLINGSHOT £4.95** For one or two players. Catch ball before it hits target. When rings disappear you can jump gaps. Five skill levels.

**MICROQUEST £4.95** Educational Adventure.

**SORCERER'S KINGDOM £4.95** Adventure game.

**ISLAND ADVENTURE £4.95** (New) Graphical adventure game.

**DISASSEMBLER £4.95** Machine code disassembler.

**TEXT DESIGNER £4.95** For designing MODE 7 graphics.

**FORECASTER £4.95** Seven ways of forecasting your pools results.

**FOOTBALL DATA £4.95** For use with FORECASTER. All results from 1976. English and Australian results contained as separate databases.

**CONCENTRATION £4.95** Card game for thinkers.

**EASIER ENVELOPES £4.95** Design your own envelopes.

**HOP & SPELL £4.95** Graphical spelling for 4/5 year olds.

**LEMGUS £4.95** Three educational games for young children.

**LIFE £4.95** The game of life.

**ANALYSIS 1 £5.95** O-Level chemical analysis (graphical).

**ANALYSIS 2 £6.95** A-Level chemical analysis (documented).

**HOME DATA £4.95** Calculate and predict your finances.

**QUESTIONS £4.95** Educational or quiz. Program your own Q and A.

**DATABASE £4.95** Includes sort, search, edit, save, etc.

**COSMONOIDS £4.95** (NEW) Invaders plus type game.

**DARTS £4.95** (NEW) In this game even you could score 180!

— ALL PRICES FULLY INCLUSIVE —

The above programs run on all O.S. and 32K.

**40% ROYALTIES** Paid to Writers of Programs.

**GLEN  
GARY  
SOFT**

9 HIGHFIELD CRESCENT,  
HORNCHURCH, ESSEX  
RM12 6QB  
TEL: HORNCHURCH  
(04024) 40864

# CONTEX

Professional Software for the BBC Computer

## TYPING TUTOR 32K

Specifically designed for the BBC micro the 90 smoothly graded lessons and the free form option teach and encourage fast touch typing. Intelligently checks for errors, monitors progress, times (WPM) and makes recommendations. Audio key feedback, metronomic pacing, clock and revised performance options. Auto keyboard/finger display for every lesson. Add own lessons if required. 12 page instruction booklet.

Cassette £9.99 inc.  
Disc £11.99 inc.

## SPREADSHEET 32K

A complete and versatile 'calc' program and tutorial. Models over 1,000 cells using up to 26 columns and 99 rows. Equations, constants, data or text in any cell. Emphasis on ease of use. 10 chr columns; 9 digit accuracy; print; row & col insert or delete; functions; colour; variables; save & restore; copy cell; auto replicate col & row; auto formulae adjust; scroll; search; help; evaluate; limits. 20 page instruction booklet.

Cassette £9.99 inc.  
Disc £11.99 inc.

## NEW

### MADLIBS

Hilarious fun for ages 7 to adult. English grammar game providing many laughs for one or more players. Educational, learn sentence constructs in a most enjoyable way. Create and save your own Madlibs.

Cassette £6.50 or disc £8.50 inc.

Fast delivery. Cassette based for models A or B with 32K, all operating systems, may be used with discs. Discs supplied are 5¼" please specify if 40 or 80 track required.

CONTEX COMPUTING (B12)

15 Woodlands Close, Cople, Bedford MK44 3UE.

Lesson 75, line 1 23

Copy text as it is presented  
Timing starts when you start  
and stops when req'd no. of  
characters typed.

I am delighted to tell you that I have  
I am delighted to tell you that I have

Your time is 20 words per minute

Press the SPACE BAR to continue

Command (? for help)

(8996)	a	b	c
	Jan	Feb	Mar
1	Car tax	75.00	0.00
2	Insure	0.00	150.00
3	Loan	150.00	150.00
4	Deprec.	100.00	100.00
5	Repairs	0.00	25.00
6	Maint.	0.00	0.00
7	Petrol	36.00	25.00
8	Oil	0.00	5.00
9	Other	12.00	3.00
10			
11	Total	373.00	458.00
12			
13	Mileage	600.00	400.00
14	MPG	30.33	29.12
15	Cost/ml	0.62	1.14

## UROM

### FOR THE BBC MICRO

UROM is a utilities chip containing a number of useful routines in an 8K EPROM. It can be fitted to your machine in minutes and contains the following facilities:

**\*\* MEMORY DISPLAY.** Display hex and ASCII equivalents of any section of memory. Page forward and back. Change bytes. Dump to printer.

**\*\* DISASSEMBLER.** 6502 mnemonics, hex and ASCII equivalents. Page forward. Dump to printer.

**\*\* BLOCK MOVE.** Shift any section of memory to a new location in RAM.

**\*\* FIND AND REPLACE.** Find all references to BASIC variable or constant and give lines at which it occurs. Replace it with another, larger or smaller.

**\*\* DISPLAY USER KEYS.** The contents of the 16 user-definable keys are displayed.

**\*\* SET UP KEYS.** The keys are set up with commonly used functions.

**\*\* EDIT ENVELOPE.** Edit any of the envelope parameters quickly and easily. The new envelope is stored and may be played by pressing one key. Edit the corresponding 'SOUND' statement. A further utility displays the BASIC 'ENVELOPE' statement.

**\*\* DEFINE CHARACTER.** Quickly edit a single character in the ASCII range 224-255. The BASIC 'VDU 23' statement is given.

**\*\* CURE 'BAD PROGRAM'.** Restore a bad or corrupted program to the point where it can be listed and edited. Works on 'unlistable' programs, too.

**\*\* 6502 MONITOR.** Display registers, stack, flags, current instruction and up to 8 selected memory locations. Continue execution to BRK, single step, skip instruction, set P-counter.

**\*\* STRING SEARCH.** Locate all references to a character or hex string in RAM.

Available now. Price includes full instructions, VAT and postage.

PRICE £19.95

J & H SOFTWARE, "The Elms", Sussex Road,  
Southport. PR9 0SJ.

## FUN TO LEARN SERIES

For the BBC B Microcomputer

A new cassette series written by a professional educationalist and developed in a school environment. The programs are menu-driven and thoroughly error-trapped with performance monitoring and good use of colour, sound and graphics. The cassettes are supplied with full documentation.

SUITABLE FOR 6 YEAR OLDS AND ABOVE

**FUN TO LEARN:** routines to test counting, word recognition, code cracking, and to help with arithmetic. Includes menu structure and performance monitor.

**MONSTER MATHS:** routines to test area estimation, mental arithmetic, times tables, arithmetic skills and logical thought. Includes automatic difficulty control and printing speed control.

SPECIAL INTRODUCTORY OFFER: £6.95 PER CASSETTE, AND £11.95 FOR BOTH.

Available now from:

## SHARDS SOFTWARE

At selected branches of Boots and all good software outlets or send cheque/PO to us at:

189 Eton Road, Ilford, Essex IG1 2UQ.



# Christmas Special

Free pair of joysticks and cassette lead with every BBC Micro ordered to be delivered by 24-12-83. Value £17.50

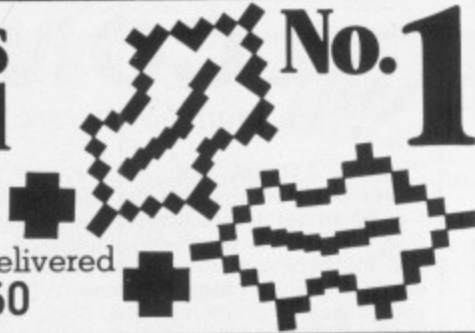

# Christmas Special

Free box of discs with every disc drive ordered which we can deliver by 24-12-83. Value £17.25 - £36.80

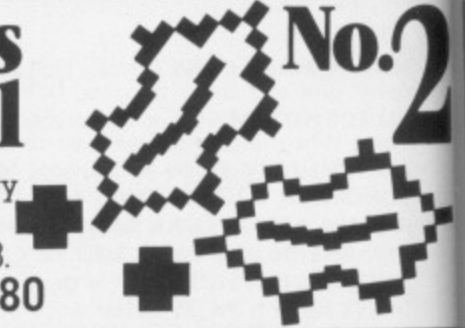

BBC Microcomputers	Price £ inc VAT
ANB01 BBC Microcomputer Model B	399.00
ANB02 BBC Microcomputer Model B+ Econet	447.51
ANB03 BBC Microcomputer Model B + Disc	498.19
ANB04 BBC Micro. Model B + Disc & Econet	545.20

BBC Microcomputer Compatible Floppy Discs		
BBC40TS Single sided 40 track discs Box of 10	17.25	
BBC40TD Double sided 40 track discs Box of 10	28.75	
BBC80TD Double sided 80 track discs Box of 10	36.80	

BBC Microcomputer Upgrade Kits		
BBCA2B Model A to B upgrade kit	69.00	
BBC3 Disc interface kit	97.70	
BBC3D Double density disc interface kit	103.45	
BBC7 Econet interface kit	70.00	
ANB14 Speech interface	55.00	

“Thank you for your prompt, helpful service.”

J.W., Langley, Berkshire

“I am impressed with your quick and efficient service.”

R.N., Peterborough

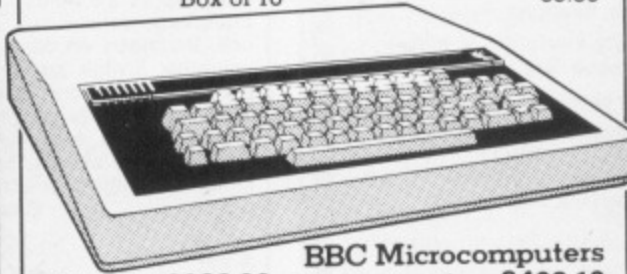

BBC Microcomputers Model B £399.00 with disc interface £498.19

### BBC Microcomputer Compatible Monitors

14MON Microvitec 1431 colour monitor	247.25
12MNON NEC 12" high resolution monitor Green phosphor	159.85
9MON NEC 9" high resolution monitor Green phosphor	148.35
STAND Monitor stand	11.44

### BBC Microcomputer Accessories

ANC01 2nd Processor 6502	195.50
ANC04 2nd Processor Z80	339.25
ANE01 Teletext receiver	225.00
BBC45 Pair of joysticks	13.00

“I was pleasantly surprised to receive your parcel yesterday only 2 working days after I first wrote to you - not many suppliers in the small computer market manage such a fast turnaround time.”

J.L., London

### BBC Microcomputer Compatible Disc Drives

BBC31S Single 100K drive	201.25
BBC31D Dual disc drive 2x100K	362.25
BBC32S Single 200K double sided drive	258.75
BBC32D Dual double sided disc drive 2x200K	483.00
BBC34S Single 400k double sided 80 track disc drive. 40/80 track switchable	327.75
BBC34D Dual double sided 80 track disc drive 40/80 track switchable	603.75

All disc drives supplied with connecting cables, utilities disc and manual.

### BBC Microcomputer Econet Accessories

AEH18 10 Station lead set	28.75
AEH15 Terminator box	35.00
AEH14 Clock box	45.00
AES20 Fileserver Level 1	99.00
AES21 Fileserver Level 2	249.00
AEH17 100m Econet cable	99.00

# Sorry Sa tough act

**Quality:** We only sell prime branded products from the industry's leading manufacturers such as Texas Instruments, Motorola, National etc. They are all current production with recent date codes. We do not buy sub standard products, manufacturers surplus or job parcels.

**Reliability:** All systems products are fully tested before despatch

and are guaranteed to be in good working order. All faults reported are fully investigated and promptly put right. Investigation has revealed that the vast majority of these faults have occurred as a result of damage caused in transit.

**Service:** All orders received by 3.30 pm are despatched that same day by 1st class post or Datapost, stock permitting. Better

# MIDWICH

COMPUTER

MIDWICH COMPUTER COMPANY, RICKINGHALL HOUSE, HINDERCLIFF



2

# Christmas Special

Free Acomsoft game (our choice of game) with every colour monitor ordered which we can deliver by 24-12-83. Value £9.95

No. 3

# Christmas Special

Free printer lead with every printer we can deliver by 24-12-83. Value £14.95

No. 4

69.00  
97.70  
103.45  
70.00  
55.00



### BBC Microcomputer Compatible Printers

RX80	Epson RX80 printer	310.50
FX80	Epson FX80 printer	425.50
LIST	Box listing paper 2000 sheets	14.95

### BBC Microcomputer Cables and Connectors

BBC21	Printer cable inc Amphenol plug	14.95
BBC22	User port connector + 36" cable	2.83
BBC23	Cassette cable 2x3.5mm + 1x2.5mm jacks	4.03
BBC24	7 pin din pl. (cassette int)	0.69
BBC25	6 pin din pl. (RGB output)	0.69
BBC26	5 pin din pl. (serial int.)	0.69
BBC27	5 pin din pl. (Econet int.)	0.69
BBC35S	Data cable single drive	9.77
BBC35D	Data cable dual drive	14.38
BBC36S	Power cable single drive	5.17
BBC36D	Power cable dual drive	6.32

### Acornsoft Languages

SBL01	Forth cassette	16.85
SBL02	Lisp cassette	16.85
SBL04	Microtext cassette	55.60
SNL02	Lisp 40 track disc	19.90
SNL01	Forth 40 track disc	19.90
SNL04	Microtext 40 track disc	59.80
SNL03	BCPL Rom disc & Manual	99.65
SBB03	View ROM	59.80

### Acorn & Acornsoft Books

SBD01	Creative Graphics	7.50
SBD02	Graphs and Charts	7.50
SBD03	Forth	7.50
SBD04	Lisp	7.50
SBD07	View guide	2.50
SBD08	Into View	2.50
SBD10	BCPL Manual	15.00
ANJ01	User Guide	10.00
BBC37	CCU DFS Manual	1.00

### Carriage Charges

Computers, Monitors, & Printers by Datapost	8.63
Disc drives, paper, 2nd Proc, Teletext Normal post	5.75
Books and joysticks by normal post	1.15
All other items by normal post	0.86



**SPECIAL TELEPHONE NUMBER FOR FAST, IMMEDIATE SERVICE, TELEPHONE YOUR ORDER TO: DISS (0379) 898751**

**“ Fantastic service - I wish more people were as 'on the ball' as you are. ”**

T.P., Tiverton, Devon

**Prices: all prices INCLUDE V.A.T. but NOT carriage. Please add the carriage to your order.**

All items offered subject to availability Government, Local Authority and educational establishment **official orders welcome.** Account facilities available subject to status otherwise strictly cash with order. Credit cards (Access & Visa) accepted with **no surcharge on all items except BBC Microcomputers.** Full refund, if requested, on out of stock items.

### Delivery

Most items are available ex-stock and orders received up to 3PM will be despatched the same day.

### Guarantee

All products are **guaranteed for 12 months** from date of purchase irrespective of original equipment manufacturers guarantee.

### Telephone Orders

24 hour service (ansaphone after hours) available for telephone orders

# anta, it's a t to follow.

All  
ght.  
ults  
hat  
tter

than 95% of the product range is in stock in depth at any one time. **Value for Money:** Due to our bulk buying power and low overheads we are able to offer very attractive prices for even modest quantities. A straight comparison of our price list with any franchised distributor will reveal a huge difference - in some cases our price is a third of the competition.

There are no minimum order charges and our post and packing costs are actual costs.

**New Acorn Electron, price £199.** We cannot promise you an Electron by Christmas owing to their scarcity, but we do promise to give you the very latest delivery information when you ring us.

# MIDWICH

## ER COMPANY LIMITED

RICKINGHALL ROAD, RICKINGHALL, SUFFOLK IP22 1HH. TEL. DISS (0379) 898751.

For **FREE CATALOGUE** post to Midwich Computer Company Limited, Rickinghall House, Hinderclay Road, Rickinghall, Suffolk IP22 1HH.

Name \_\_\_\_\_

Address \_\_\_\_\_  
\_\_\_\_\_

Telephone \_\_\_\_\_



## Quick March listing

### From Page 69

```

10 REM *****
20 REM * *
30 REM * VDU23 *
40 REM * *
50 REM * Michael Murray 1983 *
60 REM * *
70 REM * A program to redefine
  and *
80 REM * manipulate user defined
  *
90 REM * characters. *
100 REM * *
110 REM *****
120
130 MODE 1
140 VDU 5
150 DIM PARAMETER%(8,7)
160 PROCGRID
170 PROCDRAW
180 PROCCOMMANDS
190 REPEAT
  :PROCHOICE
  :PROCDRAW
  :PROCCOMMANDS
  :UNTIL FALSE
200 END
210
220 REM ***** GRID *****
230
240 DEF PROCGRID
250 FOR IX=32 TO 992 STEP 40
260 IF IXMOD 320=32 GCOL 0,3
  ELSE GCOL 0,1
270 MOVE 160,IX
  :PLOT 1,960,0
280 NEXT
290 FOR IX=160 TO 1120 STEP 40
300 IF IXMOD 320=160 GCOL 0,3
  ELSE GCOL 0,1
310 MOVE IX,32
  :PLOT 1,0,960
320 MOVE IX+4,32
  :PLOT 1,0,960
330 NEXT
340 VDU 23,224,&FF,&FF,&FF,&FF,&FF
  ,&FF,&FF,&FF
350 VDU 23,225,&FF,&C3,&C3,&C3,&C3
  ,&C3,&C3,&FF
360 ENDPROC
370
380 REM ***** DRAW *****
390
400 DEF PROCDRAW
410 GCOL 3,2
420 X%=168
  :Y%=984
430 MOVE X%,Y%
  :PRINT CHR$(225)

```

This listing was produced using a special formatter which breaks one program line over several lines of listing. When entering a line don't press Return until you come to the next line number. Full details of the formatter are in the July issue of The Micro User.

```

440 REPEAT
450 TIME =0
  :REPEAT UNTIL TIME >10
460 X1%=X%
  :Y1%=Y%
470 IF INKEY (-26) X%=X%-40
480 IF INKEY (-122) X%=X%+40
490 IF INKEY (-59) Y%=Y%+40
500 IF INKEY (-42) Y%=Y%-40
510 IF X%<168 OR X%>1088 X%=X1%
520 IF Y%<64 OR Y%>984 Y%=Y1%
530 MOVE X1%,Y1%
  :PRINT CHR$(225)
540 MOVE X%,Y%
550 IF INKEY (-90) GCOL 0,0
  :VDU 224,8
  :GCOL 3,2
560 IF INKEY (-106) GCOL 0,2
  :VDU 224,8
  :GCOL 3,2
570 VDU 225
580 UNTIL INKEY (-74)
590 VDU 8,225
600 ENDPROC
610
620 REM ***** COMMANDS *****
630
640 DEF PROCCOMMANDS
650 FX=0
660 FOR FX=704 TO 44 STEP -320
670 FOR CX=168 TO 808 STEP 320
680 FOR PX=280 TO 0 STEP -40
690 BYTEX=0
700 FOR BX=0 TO 280 STEP 40
710 IF POINT(CX+BX,RX+PX)>0 BYTEX=BYT
  EX+2^(7-BXDIV 40)
720 NEXT
730 PARAMETER%(FX,7-PXDIV 40)=BYTEX
740 NEXT
750 FX=FX+1
760 NEXT
  :NEXT
770 FOR FX=0 TO 8
780 VDU 23,224+FX,PARAMETER%(FX
  ,0),PARAMETER%(FX,1),PARAMETER%(F
  X,2),PARAMETER%(FX,3),PARAMETER%(
  FX,4),PARAMETER%(FX,5),PARAMETER%
  (FX,6),PARAMETER%(FX,7)
790 NEXT
800 CLG
  :MOVE 0,1024
  :GCOL 0,3

```

```

  :PRINT "THE COMMANDS ARE:"
  :GCOL 0,2
810 FOR FIGURE%=0 TO 8
820 PRINT "VDU23,";FIGURE%+224;
830 FOR PARAM%=0 TO 7
840 PRINT ", ";PARAMETER%(FIGURE%
  ,PARAM%);
850 NEXT
860 GCOL 0,3
  :PRINT " "CHR$(FIGURE%+224)
  :GCOL 0,2
870 NEXT
880 MOVE 286,208
  :PRINT "Mode1"
  :MOVE 576,208
  :PRINT "Mode2 or 5"
890 MOVE 320,160
900 GCOL 0,3
  :VDU 224,225,226,8,8,8,10,227
  ,228,229,8,8,8,10,230,231,232
910 PROCMODE5
920 MOVE 192,32
  :GCOL 0,2
  :PRINT "Press SPACE to continue"
  :REPEAT UNTIL INKEY (-99)
930 ENDPROC
940
950 REM ***** MODE5 *****
960
970 DEF PROCMODE5
980 FOR X%=320 TO 416 STEP 4
990 FOR Y%=64 TO 160 STEP 4
1000 IF POINT(X%,Y%)>0 MOVE X%*2
  ,Y%
  :PLOT 1,4,0
1010 NEXT
  :NEXT
1020 ENDPROC
1030
1040 REM ***** RE_DRAW *****
1050
1060 DEF PROCREDRAW
1070 GCOL 0,2
1080 FOR FX=0 TO 8
1090 X%=168+320*(FXMOD 3)
1100 FOR PX=0 TO 7
1110 Y%=984-320*(FXDIV 3)
1120 IX=PARAMETER%(FX,PX)
1130 FOR BX=0 TO 7
1140 IF IX-2^(7-BX))-1 MOVE X%+40+BX
  ,Y%-40+PX
  :VDU 224
  :IX=IX-2^(7-BX)
1150 NEXT
  :NEXT
  :NEXT
1160 ENDPROC
1170

```



BBC  
MICRO  
USER



## Deathwatch

and 24 other programs listed in the pages of BBC Micro User Vol. 1, No. 1.

BBC  
MICRO  
USER

## KING KONG



and 22 other programs listed in the pages of BBC Micro User Vol. 1, No. 2.

BBC  
MICRO  
USER

## AIR STRIKE!



and 33 other programs listed in the pages of BBC Micro User Vol. 1, No. 3.

THE  
MICRO  
USER

## SPACE PILOT

and other programs listed in the pages of BBC Micro User Vol. 1, No. 4.



THE  
MICRO  
USER

## TENPINS

and other programs listed in the pages of The Micro User Vol. 1, No. 5.



### March Issue

**DEATHWATCH**, a superb arcade game that challenges you to use your skill to fight off enemy battleships, tanks and helicopters; **BINGO**, illustrating clever uses of the randomise function; **BUBBLESORT** routines; **TESTS** for function keys in machine code routines; a useful **CASSETTE BUGS FIX** for users with OS 0.1 and many **COLOUR** and **GRAPHICS ROUTINES** to help you create a kaleidoscope of screen designs which you can incorporate into your own programs.

### April Issue

**KING KONG**, a fast moving game in which you pilot a helicopter to rescue girls perched on the Empire State Building before killing Kong; **GRAPHICS**, a suite of colourful demonstration programs; **NIM**, a structural game of strategy; **TOKENS**, first steps in unravelling the Basic ROM; **HOROSCOPES**, a fun program with useful error-trapping routines; **FORMATTER**, an essential disc utility; **DISASSEM**, a full machine code disassembler; **HEAT & LIGHT**, two measuring and plotting programs.

### May Issue

**AIR STRIKE**, a fast and furious arcade game; Test your mental powers with **PELMANISM**; 25 **ANAGRAMS**, an entertaining word game for you to play; **CHARACTER**, to generate vertical and inverted text; **TELETEXT**, animation in Mode 7, really brings the screen to life; **LAB**, a trio of programs to interface laboratory equipment; 10 programs to investigate the **OSBYTE** routine; **BEEB**, two joystick exercises; plus more **COLOUR** and **GRAPHICS** routines.

### June Issue

**SPACE PILOT**, lost in space with dwindling fuel supplies, you must fight off repeated attacks from alien life forms. To replenish fuel, you have to perform a tricky docking manoeuvre, while to repair the inevitable damage you must land on a mountainous planet. **NOMISM**, you are a nomadic herdsman desperately trying to eke out a living on the plains of Africa. Can you survive drought, tsetse fly and other hazards? **COLOURFUL CHARACTERS PLUS** other listings from the June issue.

### July Issue

**TENPIN**, a highly entertaining simulation of Tenpin Bowling; **SPACEPODS**, Try to beat alien hordes; **CUP**, Exciting techniques to bring 3D graphics to the BBC Micro; **SCRSAVE** and **CSRLOAD**, Two programs to allow you to save and load screens to tape or disc; **TEST** and **STEADY**, A pair of programs to accompany the Beeb Body Building Course; **BREAKFIX**, Don't let the Break key destroy all your precious variables! **FORMAT**, Create neater listings with this invaluable utility.

# We've got it all taped!

Save wear on your fingers — and ensure your programs are error-free — with the top-quality cassettes of programs listed in The Micro User

**£3.75**  
each (incl. p&p)

**ORDER FORM**  
**ON PAGE 99**

THE  
MICRO  
USER

## FRUITIES



and other programs listed in the pages of The Micro User Vol. 1, No. 6.

THE  
MICRO  
USER

## Robin and Marian



and other programs listed in the pages of The Micro User Vol. 1, No. 7.

THE  
MICRO  
USER

## COME FISHIN'



and other programs listed in the pages of The Micro User Vol. 1, No. 8.

THE  
MICRO  
USER

## Goblins and Blackjack



and other programs listed in the pages of The Micro User Vol. 1, No. 9.

THE  
MICRO  
USER

## Tower Bridge

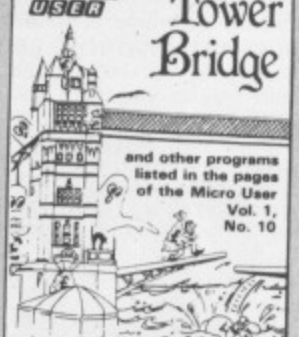

and other programs listed in the pages of the Micro User Vol. 1, No. 10.

### August Issue

**FRUITIES**, driven by strange urges you climb the ladders of adventure to risk all in the gardens of unearthly frights. Can you survive all the terrors that await you, or will you, too, fall victim to the evil Fruities? A really superb game. **ANIMATION**, a suite of programs that show you how to really bring your screen alive; **CASDISC**, The essential machine code downloader for your disc system; **MODE 7** colour routines to bring your screen to life. **PLUS** other listings from the August issue.

### September Issue

**ROBIN & MARIAN**, a highly-challenging game in which you play the part of Robin Hood rescuing Maid Marian from the clutches of the Sheriff of Nottingham. **GALACTIC INVADERS**, an extremely well-written cross between two well-known arcade games. **DFS BENCHMARKS**, 14 programs to test out disc filing systems. **ANIMATION**, four programs to teach new techniques. **Terminal**, three programs to connect a BBC Micro to a mainframe. **PLUS** other listings from the September issue.

### October Issue

**FISHING**, a compulsive simulation of a day's angling. **JOYKEY**, to convert your programs to joystick control. **PENTEST**, tests the Micro User light pen, and **BELLRINGER**, an amusing and musical way to use it. **CONTOURS**, an educational program with many uses. **LINKs**, two superb pieces of software to let BBC Micros talk to each other. **CHESS**, the winning entry in our June contest. **PLUS** six other programs from the pages of The Micro User, and all the listings from the first issue of Electron User.

### November Issue

**GOBLINS**, a journey through an enchanted forest. **BLACKJACK**, a recreation of the casino favourite. **CHARGE** and **PENDULUM**, two ingenious programs from Body Building Course part 9. **SIDEWAYS**: to store programs in sideways ROMs. **PENDRAW**, a light pen sketching program. **SOUNDS**, seven programs illustrating the excellent sound of the BBC Micro. **TUTORIAL**, listings from part 7 of our beginners' series **PLUS** all the programs from the second issue of Electron User.

### December Issue

**TOWER**, rescue London's treasure from the ghostly ghosts of Tower Bridge. **SANTA**, help Father Christmas deliver his presents despite the striking reindeer! **CARD**, an electronic greetings card from Micro User to you. **VDU 23**, an invaluable character defining utility. **PAGED**, the listing from our paged graphics article. **BODY**, the program accompanying Body Building Part 10 **PLUS** 14 other programs from the pages of The Micro User and all the listings from the third issue of Electron User.



## EDUCATIONAL SOFTWARE

For children ages 4-11

# EDUCARE'S 50

Fifty high-quality programs for primary education  
Strongly recommended by educational authorities

on the  
**ZX81**

on the  
**BBC**

MICRO

(Model A and Model B)

with  
**SPECTRUM**  
SUPPLEMENT

WITH COLOUR, SOUND AND  
OTHER ENHANCEMENTS

PROGRAMS WRITTEN IN  
STRUCTURED FORM

£5.95 Paperback  
122 pages

£7.95 Paperback  
110 pages

**NEW**

(All programs suit 1K ZX81)

These programs cover a wealth of basic concepts every child will meet in primary education. They are produced by professional educators and have been thoroughly tested in a primary school. Designed to go beyond drill & practice they promote learning through interaction and discovery. Programs range from counting and simple arithmetic to ones dealing with volume, balance and direction, mostly in form of games. Each program is short but powerful and comes with full documentation.

To:

EDUCARE  
139a Sloane St.  
London  
SW1X 9AY

Please send.....copies Educare's 50 on ZX81/Spectrum.

.....copies Educare's 50 on BBC Micro.

I enclose cheque/postal order for £.....

Name.....

Address.....

Let your child benefit early - Send now

BBC

## BBC SOFTWARE

QUALITY SOFTWARE PRODUCED BY PROFESSIONALS.

### EDUCATIONAL

Our educational software is used in hundreds of schools throughout Great Britain.

**FUN WITH WORDS** BBC ..... £8.00

Start your fun with alphabet puzzle in GUESS A LETTER. Continue your play as you learn about VOWELS, know the difference between THERE and THEIR and have games with SUFFIXES. After working so hard reward yourself with games of HANGMAN. Complete with graphics and sound. The tape includes ALPHA, VOWELS, THERE, SUFFIXES, and HANGMAN.

**EDUCATIONAL - 1** BBC/ELECTRON ..... £8.00

Hours of fun and learning for children aged 5 to 9 years. Animated graphics will encourage children to enjoy maths, spelling and telling the time. The tape includes MATH1, MATH2, CUBECOUNT, SHAPES, MEMORY, SPELL and CLOCK.

**EDUCATIONAL - 2** BBC/ELECTRON ..... £8.00

Although similar to Educational - 1 this tape is more advanced and aimed at 7 to 12 year olds. The tape includes MATH1, MATH2, AREA, MEMORY, CUBECOUNT and SPELL.

### GAMES & UTILITIES

**KATAKOMBS** 32K ..... £8.00

Are you cunning enough to discover and seize the treasure in the Katakombs AND return alive? What and where are your enemies? Can you outwit them? Yes? Then your adventure will take you through unending forests, beside tumbling streams, over the lonely plains to desolate ruins and finally to the tortuous Katakombs. Be prepared for anything!

**GAMES OF LOGIC & CUNNING** 32K ..... £8.00

For children and adults alike. The tape includes AUCTION, FLIP, REVERSE, TELEPATHY and HEXA15.

**SUPERLIFE** BBC/ELECTRON ..... £6.90

Fast (machine code) version of a popular 'Game of Life' in a large universe.

**UTILITIES** BBC/ELECTRON ..... £8.00

Behind the mundane title lies an assortment of useful procedures and functions which can save you hours/days of programming effort: date conversion, input and validation routines, graphic routines (cube, rectangle, etc) search, sort and many more.

\*\*\* SPECIAL OFFER \*\*\* Any 3 cassettes for £20.00

Add 50p per order for p/p.

Cheque/P.O. to:

**GOLEM LTD., Dept B,**  
77 Qualitas, Bracknell, Berks, RG12 4QG. Telephone:  
(0344) 50720

# Wheeler Dealer



£6.50 (including VAT and postage), on  
cassette for the BBC B 1.2 o/s.

A captivating game emulating the real business world. As boss of a small manufacturing company, you are required to make executive decisions to enable your company to survive and even prosper in the face of strong competition.

The game is dynamic: the more your skills improve the greater the competition becomes.

10 levels of difficulty exist, ranging from novice at level 0 to multi-mega expert at level 9.



No responsibility will be accepted by OIC Ltd if ill health arises due to lack of sleep caused by addiction to our products.

## Games for brains

Dealer enquiries welcome

Name..... TMU/001

Address.....

County..... Post code.....

Please send me  copies of Wheeler Dealer at £6.50 each.

I enclose a cheque/PO for £..... payable to OIC Ltd.

Send immediately to OIC Ltd., Freepost, Camberley, Surrey  
GU15 4BR.



## Quick March listing

### From Page 112

```

1180 REM ***** ROTATE RIGHT *****
    ***
1190
1200 DEF PROCROTATE_R
1210 GCOL 0,2
1220 FOR FX=0 TO 8
1230 XZ=1088-320*(FXDIV 3)
1240 FOR PX=0 TO 7
1250 YZ=984-320*(FXMOD 3)
1260 IX=PARAMETER%(FX,PX)
1270 FOR BX=0 TO 7
1280 IF IX-2^(7-BX)>-1 MOVE XZ-40*PX
    ,YZ-40*PX
    :VDU 224
    :IX=IX-2^(7-BX)
1290 NEXT
    :NEXT
    :NEXT
1300 ENDPROC
1310
1320 REM ***** MIRROR IMAGE *****
    ***
1330
1340 DEF PROCMIRROR
1350 GCOL 0,2
1360 FOR FX=0 TO 8
1370 XZ=1088-320*(FXMOD 3)
1380 FOR PX=0 TO 7
1390 YZ=984-320*(FXDIV 3)
1400 IX=PARAMETER%(FX,PX)
1410 FOR BX=0 TO 7
1420 IF IX-2^(7-BX)>-1 MOVE XZ-40*PX
    ,YZ-40*PX
    :VDU 224
    :IX=IX-2^(7-BX)
1430 NEXT
    :NEXT
    :NEXT
1440 ENDPROC
1450
1460 REM ***** ROTATE LEFT *****
    **
1470
1480 DEF PROCROTATE_L
1490 GCOL 0,2
1500 FOR FX=0 TO 8
1510 XZ=168+320*(FXDIV 3)
1520 FOR PX=0 TO 7
1530 YZ=64+320*(FXMOD 3)
1540 IX=PARAMETER%(FX,PX)
1550 FOR BX=0 TO 7
1560 IF IX-2^(7-BX)>-1 MOVE XZ+40*PX
    ,YZ+40*PX
    :VDU 224
    :IX=IX-2^(7-BX)
1570 NEXT
    :NEXT
    :NEXT
1580 ENDPROC
1590
1600 REM ***** CHOICE *****
1610
1620 DEF PROCCHOICE
1630 CLG
    :GCOL 0,3
    :MOVE 0,992
    :PRINT "WHICH OPTION ?"
1640 GCOL 0,2
    :PRINT "A. Start again." "B.
    Return to this character set."
1650 PRINT "C. Rotate right." "D.
    Rotate left."
1660 PRINT "E. Mirror image left_right
    ." "F. Exit the program."
1670 GCOL 0,3
    :PRINT "" "Press A_F"
1680 REPEAT
1690 *FX21,0
1700 G$=GET$
1710 UNTIL G$>"@" AND G$<"@"
1720 IF G$="A" RUN
1730 IF G$="F" END
1740 CLG
    :PROCGRID
1750 IF G$="B" PROCREDRAW
    :ENDPROC
1760 IF G$="C" PROCROTATE_R
    :ENDPROC
1770 IF G$="D" PROCROTATE_L
    :ENDPROC
1780 IF G$="E" PROCMIRROR
    :ENDPROC

```

*This listing is included in this month's cassette tape offer. See order form on Page 99.*

# GAMES WANTED

*"Everyone has got at least one novel inside him, and every BBC Micro owner has at least one original game waiting to be programmed." – Zen in the Art of Computer Programming.*

So says our editor in his forthcoming book. Is he correct though? Have you got a games program locked away in your subconscious, just waiting to see the light of day?

If so, get in touch with us right away – we're only too willing to hear from you. And

we've got our team of experts ready to help evaluate your work and add any necessary finishing touches.

Of course, if it's good enough, we shall want to include it in the pages of BBC Micro User. So send a copy of your original games program, on cassette or disc, to:

*The Editor, Micro User, Europa House,  
68 Chester Road, Hazel Grove, Stockport.*

And please mark your envelope clearly "GAME".



## INCREASE YOUR FIRE POWER !!!!

There you are, ZAPPING away with your laser, happily defending your planet when; suddenly – you're surrounded. Your one chance? a SMART BOMB. You reach for the keyboard – your spaceship nose dives and CRASH!!! – Wiped out. Later, on your cloud, playing your digital harp, you think "If only the SMART BOMB button had been next to the laser on the handset? I'd be alive today." "If only the joystick had sprung back to centre at least I'd still be up there fighting."

NOW!! TO SAVE THE WORLD. THE DELTA 14 RANGE OF HANDSETS FROM VOLTMACE.



Used for years by DATABASE video game owners these handsets have sprung return, nylon coated steel joysticks with graphite wiper potentiometers for longer life and SMOO-OO-OO-THER control, plus 12 pushbuttons with two extra fire buttons to share the wear.

The DELTA 14 comes in two parts. One handset will plug into the 15 way "D" plug to give analogue joystick plus three button functions. The second part is the DELTA 14B/1 adapter box which plugs onto the 15 way "D" and connects to the user port. This gives use of all 12 buttons on the user port using a 3 x 4 strobed matrix. The eighth line is used to select a second joystick which can be plugged into the adapter box. Suggested software routines included with each handset.

DELTA 14 B JOYSTICK HANDSET FOR BBC  
£12.95

DELTA 14 B/1 ADAPTER BOX & CABLE  
£13.95



*Including VAT and 1st Class Post.*



*Cheques or postal orders to:*

### **VOLTMACE LTD.,**

**Park Drive, Baldock, Herts (0462 894410)**

**Callers welcome Monday to Friday. Trade quantity discounts.**

"Maybe I could have a gatlin gun, firestreak missiles, photon torpedoes, warp drive, Hyperspace drive..."

# BBC SOFTWARE

\* Arcade Games \* Adventures \*  
\* Educational \* Utilities \* ROMS \*  
\* Languages \* and more

## HIRE

Most from £1 per fortnight

## BUY

With up to 25% discount

Membership £10

For catalogue and membership form send name and address to

Ricksoft, Dept. L, 78, Warren Drive, Hornchurch, Essex RM12 4QX.

Tel: (04024) 47722

## PRINTERLAND

EPSON DEALER SINCE 1980

Full 1 Year Warranty on all products

EPSON RX80 T	£228.00
EPSON RX80 F/T	£255.00
EPSON FX80 F/T	£339.00
EPSON FX100 F/T	£444.00
EPSON RS232 Interfaces from	

£33.00

JUKI Daisywheel	£333.00
Immediate (24 hour) delivery	£7.00

BBC/Printer Cable £8.99. FREE Excellent Machine Code Screen Dump (Cassette).

Please add 15% VAT to all prices.

### PRINTERLAND

29, Moorcroft Park, New Mill, Huddersfield HD7 7NH.

Tel: (0484) 687928/683566

Government Dept/Educational/Quantity Orders please ring.

**Barclaycard/Access**



**comec**  
**software**

Full Screen  
Editor.  
Only £5.95

New from COMEC Software comes FSED, a powerful but compact (2K) machine code utility. FSED provides the BBC micro (models A or B) with a comprehensive set of commands to allow direct editing of programs on-screen with instant entry of your changes into the program.

Supplied on high quality cassette FSED loads in less than one minute, and once loaded is completely transparent to BASIC. The editor may be loaded at any time, and is then available for use until switch-off. The editor is enabled and disabled with \*EDON and \*EDOFF.

No more tedious copying of lines to change just one character. FSED provides 16 new facilities including:

- \* Overtyping parts of a program line
- \* Inserting characters into a program line
- \* Deleting characters from a program line
- \* Splitting program lines
- \* Combining two or more program lines
- \* and many more ...

Developed and thoroughly tested by professional programmers, FSED provides editing facilities normally only found on more expensive machines.

FSED comes with a six page manual including examples of use and is available NOW. Should the program fail to load, we will of course replace it free of charge.

Send SAE for further details, or cheque/PO for £5.95 to:

**COMEC SOFTWARE,**  
**46 Newlands Road, Newcastle upon Tyne**  
**NE2 3NT.**

# MUSICSOFT

MUSIC SOFTWARE SPECIALISTS FOR  
THE BBC 32K MICRO

## ★ THE SYNTH ★ (O.S. 1.0+)

"A very flexible and inventive program that's highly recommendable." (Dr David Ellis, E&MM, Oct 83)

This 'synthesizer' program has features which to our knowledge are unique.

- \* ALTER RHYTHM. The rhythm of a recorded melody may be altered by tapping on a single key.
- \* REPEAT. No need to play a phrase twice, great saving in space.
- \* REAL TIME PLAYING. With alteration of volume, envelope and octave pitch as you play a note.
- \* EDITING. Back and forwards whilst hearing the tune.
- \* INPUT. May be hesitant or in correct time.
- \* TIDY. 'Cleans up' inaccuracies of input on demand!
- \* NUMBER OF NOTES. From 3000 for 1 channel to 1000 for 3, etc. Plus all that the other synthesizer programs do PLUS, i.e. sophisticated envelope editing (very easy), larger keyboard used (TAB to ↓ cursor). No secrets, user transparent.
- \* PROGRAM HAS AUTOMATIC TRANSFER TO DISC. This is the program for the experimenter who wants to make HUMAN music rather than perform mathematical finger dexterity exercises.

THE SYNTH. Cassette & instructions only £8.75 inc. P&P.

## ★ MUSICTOOLS 1 ★ (all O.S.)

"Musicsoft also produce an excellent 'Musictools 1' cassette ... all in all, rather good value" (E&MM, Oct 83)

Five music utility programs on one tape.

- \* ORGAN. Play, store, replay faster, slower, exactly as played (!) or smoothed out. Unique rhythm-alter feature, low notes not mentioned in the 'Guide'.
- \* TUNE GENERATOR. Creates a chord sequence, tune, quaver variations on the tune, displays a dynamic keyboard and notes on a staff as the tune is played (it LOOKS like music).
- \* CLEFTOOL. Draws musical symbols in any size you wish (within reason! 26 sizes), all are put on a staff ... Great for teaching.
- \* DATA ENTRY, 3 PART TUNE PLAYER. Simple input from data, with a seasonal demotune.
- \* ENVELOPE EXPLORER. A full envelope edit program. Display and alter all parameters with the cursors. Experiment with the sound power of your BBC Micro.
- \* OVER 60 PROCEDURES to use in your own musical programs.

MUSICTOOLS 1 cassette & instructions £5.75 inc. P&P.

## ★ PIEMAN ★

"The best version of Simon I've seen, it goes so much further than most" (Quote by a rival software firm!) Recommended for Primary & Middle Schools. Not as simple as Simon! It develops into a fun set of ear cleaning and musical concentration games - from easy at infant level to impossible at graduation! Auto scoring.

PIEMAN cassette & instructions £3.75 inc. P&P.

All programs transfer easily to disc.

Cheques and official orders to:  
MUSICSOFT, 12 Fallowfield, Ampthill, Beds.  
Telephone: 0525 402701

# Viglen

proudly present the only  
**SPECIALLY DESIGNED**



## TOTAL CONTROL CONSOLE

- ★ Keeps your hardware clean and tidy
- ★ Accommodates officially approved monitor
- ★ Wire tidy - no messy cables
- ★ Tuck away your computer when not in use
- ★ Easily transportable
- ★ Colour matched to the BBC Micro
- ★ Dimensions - 20" wide x 16" deep x 8½" high

Console Unit only **£35.00** + VAT

Console Unit + power supply **£70.00** + VAT

Please phone for any special requirements, such as Cooling fans, switches, sockets etc.

**VIGLEN Computer Supplies, Unit 7, Trumpers Way,**  
**Hanwell,**  
**London W7 2QA.**  
**Telephone: 01-843 9903**

## SPECIAL OFFER

from

# Viglen

## DISC DRIVE + INTERFACE (DFS)

### £199.95 inc VAT

1. Disc Interface (DFS) with fitting instructions (or call at factory for free fitting)
2. 100K Disc Drive cased with *all leads* (colour matched to BBC Micro)
3. User Guide
4. Formatting Disc
5. No extras - READY TO USE

**SEE US AT THE BBC MICRO USER  
SHOW (LONDON) DEC 8th - 11th -  
STANDS 28/29/30**

See full page VIGLEN COMPUTER SUPPLIES  
advert elsewhere in this issue for order form.



## Beeb Body Building Course listing

### From Page 97

```

10 MODE 7
20 PRINT "Beeb Bodybuilding Course"
30 PRINT "Sound to Pattern Converter
"
40 PRINT "THE MICRO USER"
50 PRINT "December 1983"
60 PRINT "By Mike Cook"
70 PRINT
80 PRINT "PRESS ANY KEY TO CHANGE
PATTERN"
90 *FX16,4
100 SCALEX=1024
110 OSETX=16
120 NX=8
130 DIM X%(40),Y%(40),DX%(NX,4)
,OY%(NX,4)
140 DIM SX%(4),SY%(4)
150 PROC_LOOKUP
160 AX=GET
170 MODE 7
180 PROCBAR
190 REPEAT
200 MODE 2
210 VDU 29,640;512;
220 PROC_POLYGON
230 PROC_LINE
240 PROC_TRI
250 UNTIL FALSE
260 END
270 DEF PROC_LOOKUP
280 FOR A=0 TO 40
290 X%(A)=A*16
300 Y%(A)=A*12.8
310 NEXT
320 FOR A=0 TO NX
330 FOR B=1 TO 4
340 DX%(A,B)=0
350 OY%(A,B)=0
360 SX%(B)=1
:SY%(B)=1
370 NEXT
380 NEXT
390 SX%(2)=-1
:SY%(3)=-1
400 SY%(3)=-1
:SY%(4)=-1
410 ENDPROC
420 DEF PROC_LINE
430 CLS
440 VDU 23,1,0;0;0;0;
450 LOCAL AX,BX,CX,NPX
460 NPX=1
470 REPEAT
480 GCOL 3,RND(7)

```

This listing was produced using a special formatter which breaks one program line over several lines of listing. When entering a line don't press Return until you come to the next line number. Full details of the formatter are in the July issue of The Micro User.

```

490 FOR AX=1 TO 4
500 PROC_SAMP(AX)
510 DX%(NPX,AX)=X%(VX)
520 OY%(NPX,AX)=Y%(VX)
530 NEXT
540 FOR AX=1 TO 4
550 FOR BX=1 TO 4
560 FOR CX=1 TO 4
570 MOVE SX%(CX)*DX%(NPX,BX),0
580 DRAW 0,SY%(CX)*OY%(NPX,AX)
590 NEXT
:NEXT
:NEXT
600 NPX=NPX+1
610 FOR AX=1 TO 4
620 FOR BX=1 TO 4
630 FOR CX=1 TO 4
640 MOVE SX%(CX)*DX%(NPX,BX),0
650 PLOT 7,0,SY%(CX)*OY%(NPX,AX)
660 NEXT
:NEXT
:NEXT
670 UNTIL NOT (INKEY (0))
680 ENDPROC
690 DEF PROC_POLYGON
700 CLS
710 VDU 23,1,0;0;0;0;
720 LOCAL AX,NPX
730 NPX=1
740 REPEAT
750 GCOL 1,RND(7)
760 FOR AX=1 TO 4
770 PROC_SAMP(AX)
780 DX%(NPX,AX)=SX%(AX)*X%(VX)
790 OY%(NPX,AX)=SY%(AX)*Y%(VX)
800 NEXT
810 MOVE DX%(NPX,1),OY%(NPX,1)
820 FOR AX=2 TO 4
830 DRAW DX%(NPX,AX),OY%(NPX,AX)
840 NEXT
850 DRAW DX%(NPX,1),OY%(NPX,1)

```

This listing is included in this month's cassette tape offer. See order form on Page 99.

```

860 NPX=NPX+1
870 IF NPX>NX
THEN NPX=1
880 MOVE DX%(NPX,1),OY%(NPX,1)
890 FOR AX=2 TO 4
900 PLOT 7,DX%(NPX,AX),OY%(NPX,AX)
910 NEXT
920 PLOT 7,DX%(NPX,1),OY%(NPX,1)
930 UNTIL NOT (INKEY (0))
940 ENDPROC
950 DEF PROCBAR
960 VDU 23,1,0;0;0;0;
970 CLS
980 PRINT "BAR GRAPH OF SOUND"
990 PRINT
1000 PRINT "SET UP VOLUME LEVELS"
1010 REPEAT
1020 PRINT TAB(0,8)
1030 TIME =0
1040 FOR A=1 TO 4
1050 PROC_SAMP(A)
1060 PRINT STRING$(VX,"*");SPC(40-VX)
1070 NEXT
1080 UNTIL NOT (INKEY (0))
1090 ENDPROC
1100 DEF PROC_SAMP(CX)
1110 VX=ADVAL (CX) DIV SCALEX - OSETX
1120 IF VX<0
THEN VX=0
1130 IF VX>39
THEN VX=39
1140 ENDPROC
1150 DEF PROC_TRI
1160 LOCAL NPX,AX
1170 NPX=1
1180 CLS
1190 REPEAT
1200 FOR AX=1 TO 4
1210 MOVE DX%(NPX,AX),OY%(NPX,AX)
1220 PLOT 7,0,OY%(NPX,AX)
1230 PLOT 7,DX%(NPX,AX),0
1240 PLOT 7,DX%(NPX,AX),OY%(NPX,AX)
1250 GCOL 0,RND(7)
1260 PROC_SAMP(AX)
1270 DX%(NPX,AX)=X%(VX)*SX%(AX)
1280 OY%(NPX,AX)=Y%(VX)*SY%(AX)
1290 MOVE DX%(NPX,AX),OY%(NPX,AX)
1300 DRAW 0,OY%(NPX,AX)
1310 DRAW DX%(NPX,AX),0
1320 DRAW DX%(NPX,AX),OY%(NPX,AX)
1330 NEXT
1340 NPX=NPX+1
1350 IF NPX>NX
THEN NPX=1
1360 UNTIL NOT (INKEY (0))
1370 ENDPROC

```



# Add 20K to your BBC micro in five minutes



## - ARIES-B20 -

### Features

- ★ Adds 20K of useable RAM to your BBC Micro
- ★ Run programs up to 28K long in ANY SCREEN MODE
- ★ Extra memory can be used directly from BASIC I and II, VIEW 1.4, FORTH, LISP, and many other existing programs
- ★ ARIES-B20 is compatible with all correctly written BBC Micro software, on cassette, disc, sideways ROM or cartridge
- ★ Don't be deceived: this product is unique - no other expansion unit has these capabilities
- ★ Complete compatibility - ARIES-B20 uses only documented MOS facilities
- ★ Fitted in 5 minutes using only a screwdriver
- ★ Simply plugs in inside the case
- ★ No soldering or cutting
- ★ (Unlike some add-on products) will cause no damage to your

- ★ BBC Micro - can be removed at any time
- ★ Incredibly simple to use
- ★ Patent applied for
- ★ Designed in Cambridge by BBC Micro experts
- ★ Top quality manufacture
- ★ Unquestionably the most important add-on ever produced for the BBC Micro.
- ★ Top software houses are racing to produce the "super-programs" made possible by the extra capacity
- ★ 1 year guarantee.
- ★ Available mail-order only
- ★ Official purchase orders accepted from bona-fide educational establishments, all other trade cash-with-order

- ★ Price £99.95 including post, packing and VAT
- ★ If not completely satisfied with your purchase, we will refund your money in full providing you return the ARIES-B20 in good condition in its original packaging within 14 days

### Machine requirements:

- ★ BBC Micro model B
- ★ MOS 1.2 or later
- ★ Plugs into CPU socket and 1 sideways ROM socket

Also available IEEE-488 interface.  
Coming soon: Compatible ROM expansion board.

### How to Order:

Send cheque or postal order made payable to: Cambridge Computer Consultants Ltd and forward to:  
Cambridge Computer Consultants Ltd, FREEPOST, Cambridge CB1 1BR.  
Telephone Cambridge 0223- 210677

Please send me (Qty).....ARIES- B20(s) at £99.95 (incl. p.p. & VAT).  
I enclose a cheque/postal order made payable to  
Cambridge Computer Consultants Ltd for £.....  
Signed.....  
Name (block letters).....  
Address.....  
..... Post Code.....

Cambridge Computer Consultants Ltd, FREEPOST Cambridge CB1 1BR  
Telephone Cambridge 0223-210677



## HARDWARE AND SOFTWARE **Micro-Aid** FOR THE BBC MICRO

SOFTWARE - Programs that are guaranteed to run! Save hours of work and worry with these utilities and practical programs on cassette or disc. Orders are posted the same day.

102	CASHBOOK	Double entry 4 columns with accounts & analysis	£ 7.95	B
102d	CASHBOOK	Full disc version. 1100 items on 100k disc	£13.95	B
103	LEDGER	Complements CASHBOOK with ageing & analysis	£ 7.95	B
105	MAILING	Holds 218 addresses. Alpha & post code sorts, fast search any format labels & delete, add and amend.	£ 7.95	B
106	PAYROLL (W or M)	In 2 parts to handle weekly or monthly (state which) PAYE & NI for 100 employees. Fully supported	£17.95	B
106a	Manual	30 page A4 manual with examples. Extra. No VAT.	£ 2.50	
107	MEMO-CALC	Database/Calcsheet with up to 255 columns, string or numeric data, sorts, searches, calculations, with automatic fully formatted printout facility	£ 9.95	B
107a	Manual	20 page A4 manual with examples. Extra. No VAT.	£ 2.00	
201	GAMES 1	5 Card, Minefield, Darts, Pontoon & Mrmidon.	£ 4.95	B
203	HANGMAN	Word game in English, French, German, Italian, Spanish	£ 7.95	B
301	BANNER	Print large text and graphics on paper for displays	£ 2.95	A/B
302	DISTANCES	Three graphic maps of U.K., EUROPE & the WORLD Calculate the distance between any 2 places	£ 4.95	B
303	FLAGS	98 full colour flags of the world with questions	£ 4.95	B
304	STATPAK	Statistics package giving over 30 results	£ 9.95	B
504	PROCAID	includes SEARCHBAS to search a BASIC program and alter it. PROCVAR to list variables in a BASIC program & PROCFLUSH to clear resident integers in RAM	£ 3.45	A/B
505	UTILITY-A	Our best selling tape includes PROCAID, DEFCHR to design, display & store graphic characters, SORTM/C a very fast machine code numeric sort, SORTBAS The undisputed fastest BASIC sort routine	£ 5.95	A/B
600	FORTH	'79 FORTH second language ROM for either OS	£34.74	B
601	LOGO-FORTH	Advanced Turtle Graphics Language ROM	£55.00	B
602	PASCAL-T	Structured language ROM with compiler-interpretor	£55.00	B
603	XCAL	Computer Assisted Learning ROM	£65.00	B
605	WORDWISE	Superb fast & easy Wordprocessor in ROM	£34.74	B
606	BEEB-CALC	ROM based spread sheet with floating point maths	T.B.A.	B
607	DISKDOC	ROM for disk problems in format, search, files etc	£27.50	B
700	BOOKS	Various titles for the BBC Micro from	£ 6.95	
801	CASSETTES	C12 Computer quality tapes boxed in 10's	£ 4.50	
810	5 25" DISCS	MEMOREX Soft sectored 40 track S/S discettes	£19.95	
900	SEIKOSHA	GP700A NEW 7 COLOUR dot matrix printer 50cps	£369.00	
901	EPSON RX-80	Superb printer 100cps, 3 fnts, graphics, tractor	£269.00	
901a	EPSON RX-80	T/F Same as above, with Tractor and Friction feed	£TBA	
902	EPSON FX-80	Magnificent. 160cps, 6 founts, graphics, F/T Roll	£379.00	
910	DISC DRIVES	Slimline TEAC or MITSUBISHI with power supply, 100k - 800k format disc cable and excellent manual. From	£199.00	
920	VDU STAND	Stainless Steel Support protects your micro	£19.95	
930	COLOUR TV	CABEL 14" Colour Monitor 10Mhz 430 pixels	£189.50	

NEW FRENCH ABROAD Traveller's phrases in English and French with voice back-up £7.95

ADD VAT TO ALL PRICES EXCEPT MANUALS AND BOOKS.  
FOR COPIES ON DISCS ADD £1.75 PER DISC. NO PACKING CHARGES.  
MOST PROGRAMS AVAILABLE ON MICRONET 800.

If you want further information before parting with your hard earned cash send for our free brochure to:-  
Micro-Aid (MU)

25 Fore Street, Praze, Camborne,  
Cornwall TR14 0JX.  
Tel: 0209-831274

NEW HITACHI 100K  
3" Disc Drives  
£225 inc.

See us on Stand 16  
BBC Micro User Show,  
London

## QUALITY BBC SOFTWARE

DATABASE:- £12.95 Cass. £15.95 Disc. (INC.)

Make card-filing obsolete. For cassette and disc operation (32K), many facilities found only on more expensive systems: \*Variable field length. \*Fast sort, any field. \*Search and replace. \*Fast search through fields. \*Specific, between-range, wildcard search. \*Record amend (on screen editing), delete, replace. Can be used as sophisticated mailing list as well as for school/class/club/business records, directories, inventories, catalogues, as teaching resource where data compilation and classification are required. Comprehensively documented.

EEL:- £7.95 INC

The only way to learn number bonds and tables. Guide the eel and eat the number family. 20 levels of difficulty, making it suitable for 6 year olds upwards. Includes full user performance record for teacher/parent. Keyboard or joystick operation. Very addictive.

PLOTAPIC:- £7.95 INC.

Display and presentation program that allows pictures to be created using co-ordinate procedures. Results can be linked together to form story. Comes complete with picture story of Nativity. Age range - 8+.

MICRO CASE:- £35.00 + £3.00 pp.

Smart, strong, foam-lined lockable. Holds BBC micro, recorder/disc drive, cassettes, cables. Black with aluminium trim.

Cheque, Access/Visa (Phone anytime).

Official order to:

### PRIMASOFT

FREEPOST, GLOSSOP, DERBYS. SK13 9YB.

Tel. GLOSSOP 62743

Excellent royalties for quality educational software.

DEALER ENQUIRIES WELCOME

## SPELLWISE

Dear Farther Christmas,

Four Christmass this year I wud lyke an Exekutive jet (just too kompleat me set), an otha villa but this tim in spane nott franse. I hav allways fansied miself at golf so perhaps yoo cud leve me a kuple ov golf klubs? StAndrews and Wentworth for instance, a helikopta, togetha wiv landing pads at all mi howses. And how about a nu yot, but biga than the thowsunt ton affair you gave me larst Kristmus. A biga trane s (British Rail?), but peraps i hav allredi asked four tv much, i mustn't be gredi . . . . .

NOW ON  
DISC  
AND TAPE

SPELLWISE for the man who has everything . . . . .

### SPELLWISE

- \* is a spelling checker for use with your BBC micro and WORDWISE word processor
- \* is a DISC or tape based machine code program with comprehensive user manuals
- \* contains an expandable dictionary of over 6000 words (disc) or 3000 words (tape)

SPELLWISE comprises a set of one disc (or two tapes) plus a complete user manual. The tape version is limited to cassette recorders with motor control. SPELLWISE costs £12 on tape, £18 on disc and can be obtained from:-

DATAWARE FREEPOST SWINDON SN3 4BR



## GARLAND COMPUTING

35 DEAN HILL . PLYMOUTH . PL9 9AF. TELEPHONE: 0752 41287

### NEW BBC RELEASES

**LEARNING MATHS** A series of programs for ages 9-12. Each package contains 3 to 4 programs, many with animations and entertaining games to help learn the principles of maths in school or at home. (Each Package £7.00)

Angles . Directed Numbers . Fractions . Co-ordinates and Lines . Symmetry . Motion Geometry . Sets . Elementary Statistics . Ratios

**MUSIC TUTOR** A unique and absorbing program which helps you to learn or create music. Notes can be entered in various ways, and the pitch and duration displayed on the screen on a treble clef. Other options allow you to play back, alter, make permanent copy and more. Full documentation (£10.95)

**EDUCATIONAL GAMES** Three programs which will provide fun for all the family and help to improve children's spelling, concentration or ability to estimate angles and distances. (Each £5.95)

Wordsquare . Pick-A-Pair . Sea-Battle

Prices include VAT and P&P. Available by mail order, or from selected computer stores and educational suppliers. Send for full details of our extensive range of educational software.

**THE EDUCATIONAL SPECIALISTS**

35 DEAN HILL . PLYMOUTH . PL9 9AF  
TELEPHONE 0752 41287



## Christmas card listing

From Page 81

```

: PLOT 69,X,Y+4
600 PLOT 69,X+1151,Y
: PLOT 69,X+1143,Y+4
610 NEXT
620 colour1=colour1+1
: IF colour1=8
THEN colour1=0
: colour2=colour2+1
: IF colour2=8
THEN colour2=colour1
630 NEXT
640 VDU 5
: VDU 29,0;0;
: GCOL 0,6
: MOVE 160,160
: PRINT "Merry Christmas
"
650 VDU 29,635;550;
: GCOL 0,7
: PROCcandles
660
670
680 DEF PROCtree(Xcentre
,Ycentre)
690 VDU 29,Xcentre;Ycentre;
700 black=0
: red=1
: green=2
: yellow=3
: blue=4
: white=7
710 PROCtriangle(green
,-4,3,0,7,4,3)
720 PROCtriangle(green
,-5,0,0,4,5,0)
730 PROCtriangle(green
,-6,-3,0,1,6,-3)
740 PROCbox(white,-1,-3
,1,-3,-1,-4,1,-4)
750 PROCbox(red,-2.5,-4
,-1.5,-6,2.5,-4,1.5
,-6)
760 ENDPROC
770
780
790 DEF PROCtriangle(colour
,X1,Y1,X2,Y2,X3,Y3)
800 GCOL 0,colour
: PROCmusic
810 MOVE X1*hsize,Y1*vsize
: MOVE X2*hsize,Y2*vsize
: PLOT 85,X3*hsize
,Y3*vsize
: ENDPROC
820
830 DEF PROCbox(colour
,X1,Y1,X2,Y2,X3,Y3
,X4,Y4)
840 GCOL 0,colour
850 MOVE X1*hsize,Y1*vsize
: MOVE X2*hsize,Y2*vsize
: PLOT 85,X3*hsize
,Y3*vsize
: PLOT 85,X4*hsize
,Y4*vsize
: ENDPROC
860
870 DEF PROCballs
: VDU 5
880 FOR vposn=-3*vsize
TO 7*vsize STEP vsize/3
890 FOR hposn=-6*hsize
TO 6*hsize STEP hsize/3
900 IF RND(100)>95
AND POINT(hposn,vposn)=
green
THEN MOVE hposn-24
,vposn+16
: GCOL 0,RND(15)
: PRINT CHR$ 225
: GCOL 0,white
: PLOT 69,hposn+16
,vposn+8
910 NEXT
: PROCmusic
: NEXT
: ENDPROC
920
930 DEF PROCcandles
940 PROCpiece(white,0
,224)
950 PROCpiece(yellow,1
,226)
960 PROCpiece(red,1,227)
970 PROCpiece(yellow,1
,228)
980 PROCdelay(20)
990 PROCpiece(yellow,1
,226)
1000 PROCpiece(red,1,227)
1010 PROCpiece(yellow,1
,228)
1020 GOTO 950
1030 ENDPROC
1040
1050 DEF PROCtrunk(X1,X2
,Y1,Y2)
1060 GCOL 0,1
: MOVE X1*hsize,Y1*vsize
: MOVE X1*hsize,Y2*vsize
: PLOT 85,X2*hsize
,Y1*vsize
: PLOT 85,X2*hsize
,Y2*vsize
1070 GCOL 0,2
1080 FOR X=X1*hsize
TO X2*hsize+8 STEP 16
1090 MOVE X,Y1*vsize
: DRAW X,Y2*vsize+4
1100 NEXT
1110 ENDPROC
1120
1130 DEF PROCpiece(colour
,offset,char)
1140 offset=offset*32
1150 GCOL 3,colour
: MOVE -4*hsize-24
,3.5*vsize+offset
: PRINT CHR$ char
: MOVE 4*hsize-24,3.5*v
size+offset
: PRINT CHR$ char
: MOVE -5*hsize-24
,.5*vsize+offset
: PRINT CHR$ char
1160 MOVE 5*hsize-24,.5*vsize
+offset
: PRINT CHR$ char
: MOVE -6*hsize-24
,-2.5*vsize+offset
: PRINT CHR$ char
: MOVE 6*hsize-24,-2.5*v
size+offset
: PRINT CHR$ char
: ENDPROC
1170
1180
1190 DEF PROCmusic
1200 IF ADVAL (-6)=0
THEN ENDPROC
1210 READ note$
: IF note$="END"
THEN RESTORE 1270
: GOTO 1210
1220 IF LEFT$(note$,1)=
"0"
THEN octave=VAL (
RIGHT$(note$,1))
: GOTO 1210
1230 t=VAL (RIGHT$(note$
,1))
: note$=LEFT$(note$
,1)
1240 freq=INSTR(octave$
,note$)*4+1+48*(octave-
2)
1250 SOUND 1.1,freq,t*4
: GOTO 1200
1260 REM * THE FIRST NOWELL
*
1270 DATA 03,e1,d1,c3,d1
,e1,f1,q4,a1,b1,04
,c2,03,b2,a2,q4,a1
,b1
1280 DATA 04,c2,03,b2,a2
,q2,a2,b2,04,c2,03
,q2,f2,e4,e1,d1,c3
,d1,e1,f1
1290 DATA q4,a1,b1,04,c2
,03,b2,a2,q4,a1,b1
,04,c2,03,b2,a2,q2
,a2,b2
1300 DATA 04,c2,03,q2,f2
,e4,e1,d1,c3,d1,e1
,f1,q4,04,c1,03,b1
,a4,a2,q6,04,c2,03
1310 DATA b2,a2,q2,a2,b2
,04,c2,03,q2,f2,e8
1320 REM *0 COME ALL YE
FAITHFUL *
1330 DATA q2,q4,d2,q2,a4
,d4,b2,a2,b2,04,c2
,03,b4,a2,q2
1340 DATA q4,F#2,e2,F#2
,q2,a2,b2,F#4,e3,d1
,d8,04,d4,c2,03,b2
,04,c4,03,b4
1350 DATA a2,b2,q2,a2,F#3
,e1,d2,g2,g2,F#2,g2
,a2,q4,d2,b2,b2
1360 DATA a2,b2,04,c2,03
,b4,a2,b2,04,c2,03
,b2,a2,q2,F#4,q2,04
,c2,03,b4,a3,q1,q8
1370 REM *WHILE SHEPHERDS
WATCH*
1380 DATA f2,a3,a1,q2,f2
,A#2,A#2,a2,q2,a2
,04,c2,c2,03,b2,04
,c6,03,a2,04,d3,c1
1390 DATA 03,A#2,a2,q2
,f2,e2,a2,q2,f2,f2
,e2,f8
1400 REM *SILENT NIGHT*
1410 DATA q3,a1,q2,e6,q3
,a1,g2,e6,04,d4,d2
,03,b6,04,c4,c2,03
,q6,a4,a2,04,c3,03
1420 DATA b1,a2,g3,a1,g2
,e6,a4,a2,04,c3,03
,b1,a2,g3,a1,g2,e6
,04,d4,d2,f3,d1,03
1430 DATA b2,04,c6,e6,c2
,03,q2,e2,g3,f1,d2
,c9
1440 DATA END
1450 DEF PROCdelay(t)
: T=TIME +t
: REPEAT PROCmusic
1460 UNTIL TIME >T
: ENDPROC
1470 END

```



# BBC MICRO BOOKSHOP

Probably the best elementary BBC Basic text. An exceptionally readable book which more than lives up to its title.

**£6.95**

**Easy Programming for the BBC Micro**  
Eric Deeson



This is the helpful book that goes with the current BBC-TV series and gives advice on getting started.

**£7.75**

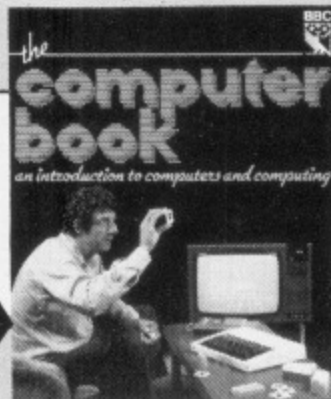

A cheerful introduction to computing. It tells you what a computer is, what it does and how to make it work.

**£5.50**



ASSEMBLY LANGUAGE PROGRAMMING for the BBC MICROCOMPUTER



Ian Birbaum

One of the best assembly language books ever written. Comprehensive, and specially compiled for the BBC Micro.

**£9.95**

ADVANCED PROGRAMMING TECHNIQUES FOR THE BBC MICRO  
JIM MCGREGOR & ALAN WATT

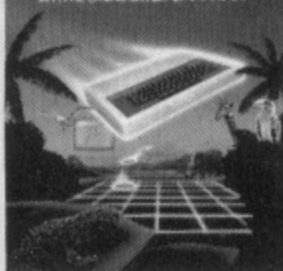

Advanced programming for the BBC Micro ranging from databases to animated games, text processing to artificial intelligence.

**£8.95**

Structured Programming With BBC Basic  
BOB AMERSON



A clearly written manual on good Basic programming and problem solving. This book could become the standard work.

**£7.50**

## ORDER FORM

All prices include postage and packing

Please supply the following book(s)

Please enter number required in box

- |                          |   |        |       |
|--------------------------|---|--------|-------|
| <input type="checkbox"/> | The BBC Micro Book BASIC, Sound and Graphics            | £8.95  | ..... |
| <input type="checkbox"/> | Programming the BBC Micro                               | £7.50  | ..... |
| <input type="checkbox"/> | Easy Programming for the BBC Micro                      | £6.95  | ..... |
| <input type="checkbox"/> | Advanced Programming techniques for the BBC Micro       | £8.95  | ..... |
| <input type="checkbox"/> | Assembly Language Programming on the BBC Micro          | £8.95  | ..... |
| <input type="checkbox"/> | BBC Micro User Guide                                    | £10.95 | ..... |
| <input type="checkbox"/> | Assembly Language Programming for the BBC Microcomputer | £9.95  | ..... |
| <input type="checkbox"/> | The BBC Micro Revealed                                  | £8.95  | ..... |
| <input type="checkbox"/> | The Book of Listings                                    | £4.75  | ..... |
| <input type="checkbox"/> | 30+ Programs for the BBC Microcomputer                  | £5.95  | ..... |
| <input type="checkbox"/> | Further Programming for the BBC Micro                   | £6.95  | ..... |
| <input type="checkbox"/> | The Computer Book                                       | £7.75  | ..... |
| <input type="checkbox"/> | The Friendly Computer Book                              | £5.50  | ..... |
| <input type="checkbox"/> | Structured Programming with BBC Basic                   | £7.50  | ..... |
| <input type="checkbox"/> | The BBC Micro: An expert guide                          | £7.95  | ..... |

I enclose my cheque/P.O. for

Cheques payable to Database Publications

Name .....

Address .....

Post to: Database Publications, Europa House, 68 Chester Road, Hazel Grove, Stockport SK7 5NY.

These special prices apply to UK readers only. Prices to overseas readers are available on request.

Learn to make use of the micro's hidden depths with this comprehensive introduction to using the BBC Micro's powerful assembler.

**£8.95**

ASSEMBLY LANGUAGE PROGRAMMING ON THE BBC MICRO  
JOHN FERGUSON & TONY SHAW



THE BBC MICRO BOOK BASIC, Sound and Graphics  
JIM MCGREGOR & ALAN WATT



A clear, concise and thorough introduction to good programming techniques on the BBC Micro. The book the experts recommend.

**£8.95**

An easy-to-follow, step-by-step guide to more advanced BBC Basic, following on from Easy Programming for the BBC Micro.

**£6.95**

Further Programming for the BBC Micro

Alan Thomas



THE BBC MICRO an expert guide



MIKE JAMES

An intelligent, information manual on the workings of the BBC Micro. Recommended reading for anyone beyond the beginner's stage.



*For the Brightest  
and Best*

Microvitec Cub 452 is by far the largest selling colour display for the BBC microcomputer:-

**WHY?**

- \* It is the only colour monitor approved and recommended by both Acorn and the BBC.
- \* 95% of schools have chosen Cub 452 under the Department of Industry Micros in schools scheme.
- \* Cub is designed and manufactured in the U.K.

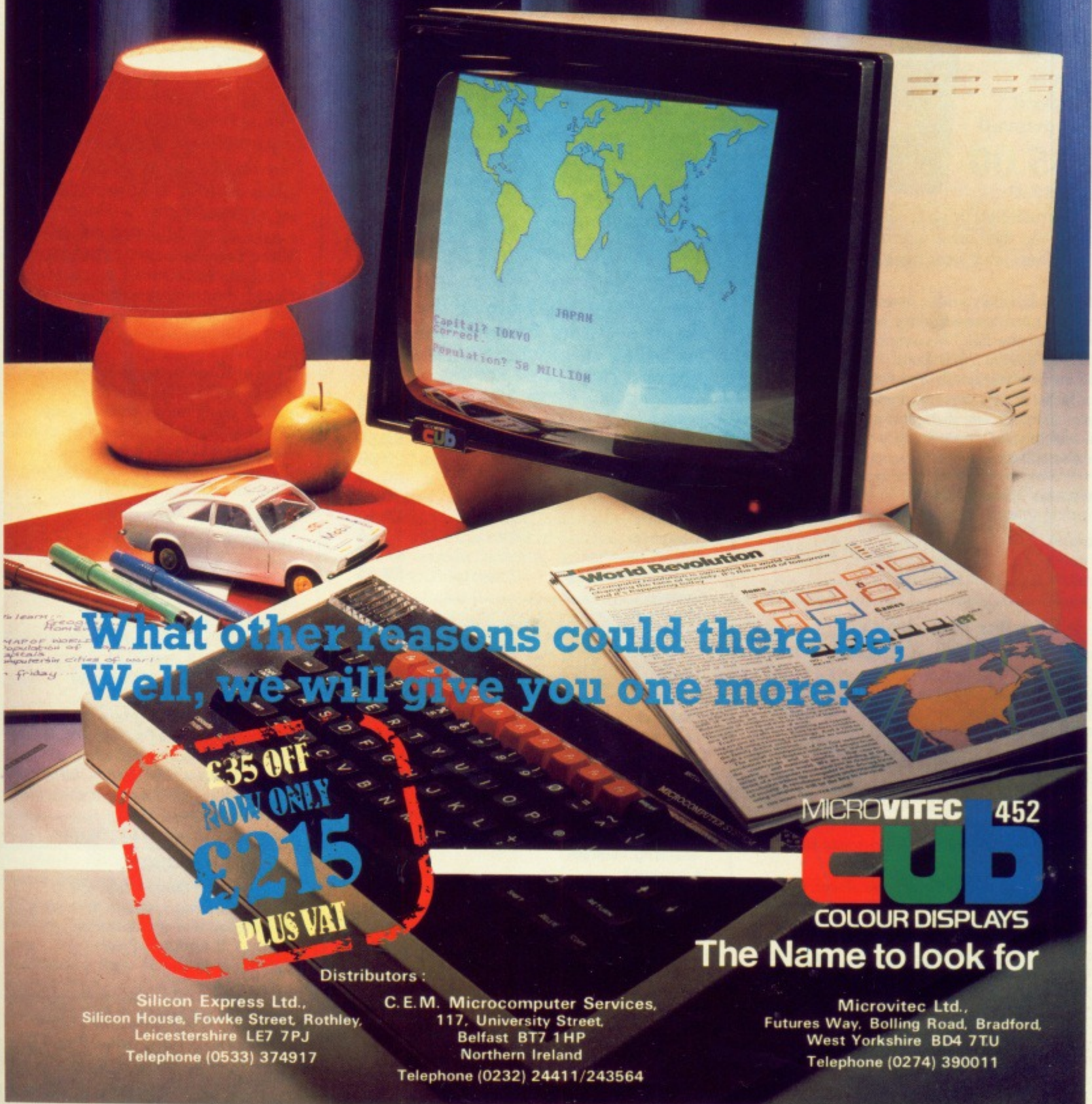

**What other reasons could there be,  
Well, we will give you one more:-**

**£35 OFF  
NOW ONLY  
£215  
PLUS VAT**

MICROVITEC 452

**CUB**

COLOUR DISPLAYS

**The Name to look for**

Distributors:

Silicon Express Ltd.,  
Silicon House, Fowke Street, Rothley,  
Leicestershire LE7 7PJ  
Telephone (0533) 374917

C. E. M. Microcomputer Services,  
117, University Street,  
Belfast BT7 1HP  
Northern Ireland  
Telephone (0232) 24411/243564

Microvitec Ltd.,  
Futures Way, Bolling Road, Bradford,  
West Yorkshire BD4 7TU  
Telephone (0274) 390011



# National Micro

## DATA STORAGE

A data cassette recorder that perfectly matches the BBC Micro.

**£34.74**

Carriage £2.50



Fully compatible with the BBC Micro and specifically designed for data saving and loading, the Pye data cassette recorder (with free power pack and BBC lead) is guaranteed to end your data storage and retrieval problems.

A low cost answer to high speed data retrieval!

**£135.00**

Carriage £3.50



Are you frustrated by your cassette system but find the disc drive alternative too costly? Then what you need is The Hobbit.

The Hobbit is a high quality, ultra fast, fully automatic micro cassette drive specially designed for the BBC Microcomputer. It reads and writes data at 7500 Baud - more than sufficient for most needs and about seven times faster than a cassette recorder. It has a proper directory, like discs and a file space of 101k. All this, for approximately half the price of a disc system.

### Cumana disc drives

Including integral power supply

**Cumana CS50 A 100k Single**  
(40 track) ..... **£178.26**  
**Cumana CD50A 200k Dual**  
(40 track) ..... **£347.83**

### Pace Slimline disc drives

**Pace PSD1 100k Single** ..... **£185.00**  
**Pace PSD2 200k Single** ..... **£235.00**  
**Pace PSD3 400k Single**  
(40/80 track, switchable) ..... **£345.00**  
**Pace PDD1 200k Double**  
(40 track) ..... **£338.00**  
**Pace PDD2 400k Double**  
(40 track) ..... **£449.00**  
**Pace PDD3 800k Double** (40/80 track,  
switchable) ..... **£610.00**

All the above drives are cased in metal to prevent interference and data loss.

Carriage on disc drives £3.50

Upgrade your BBC Micro into a complete business machine with the

### Torch Z80 Disc Pack

Gives a massive 800k of storage and a Z80 second processor enabling you to access a wide range of CP/M compatible software.

Order now and you'll be given more than £1.100 worth of free software: Perfect Writer (word processing), Perfect Speller (spelling checker), Perfect Calc (spreadsheet), Perfect Filer (database), Comanex business management game), and the Torchnet networking system.

**PLUS £1,100**  
**of free software! £730**

### High-quality discs from BASF

Single sided, single density  
(box of 10) ..... **£16.09**  
Double sided, double density  
(box of 10) ..... **£26.04**  
Blank data cassettes (box of 10) ..... **£4.35**

### Disc utilities

If you're upgrading to disc you must get **Replica**. It enables you to easily transfer your existing cassette programs to disc and stores 8-10 programs. Both 40 and 80 track versions are available (please state which you require). Fully compatible with the Amcom DFS.

**£8.65**

A comprehensive utility providing a number of essential facilities is **The Key**. This multi purpose disc enables you to back up existing discs (including most of the protected ones), retrieve deleted files and edit your own discs. State whether you require the 40 or 80 track version.

**£11.26**

## SOFTWARE

We stock games from all the major software houses. Below are some of our best sellers:

### ACORNSOFT

**Sphinx Adventure** ..... **£8.65**  
**Philosophers Quest** ..... **£8.65**  
**Castle of Riddles** ..... **£8.65**  
**Countdown to Doom** ..... **£8.65**  
**Rocket Raid** ..... **£8.65**  
**Arcade Action** ..... **£10.35**  
**Snapper** ..... **£8.65**  
**Monsters** ..... **£8.65**  
**Arcadians** ..... **£8.65**  
**Business Games** ..... **£8.65**  
**Snooker** ..... **£8.65**  
**Missile Base** ..... **£8.65**  
**Starship Command** ..... **£8.65**

**NEW! NEW! NEW! NEW! NEW! NEW!**

**Hopper** ..... **£8.65**  
Hop the frog to safety through a variety of dangers. Complete with music and full sound effects.

**JCB Digger** ..... **£8.65**  
You are in charge of a JCB, which can move in four directions and dig holes to trap the attacking Meanies.

**Carousel** ..... **£8.65**

Personal shoppers can obtain the products advertised on these pages from the following retail stores:

**Stockport Micro Centre**  
4/6 Brown St., Stockport,  
Greater Manchester.  
Tel: 061-480 0539

**Wilmslow Micro Centre,**  
62 Grove Street.,  
Wilmslow, Cheshire.  
Tel: 0625 530891

### A&F

**Painter** ..... **£8.00**  
**Frogger** ..... **£8.00**  
**Planes** ..... **£8.00**  
**Howzat** ..... **£8.00**  
**Shrinking Professor** ..... **£8.00**

### DIGITAL FANTASIA

**Golden Baton** ..... **£8.95**  
**The Time Machine** ..... **£8.95**  
**Arrow of Death Pt 1** ..... **£8.95**  
**Arrow of Death Pt 2** ..... **£8.95**  
**Escape from Pulsar 7** ..... **£8.95**  
**Circus** ..... **£8.95**  
**Feasibility Experiment** ..... **£8.95**  
**Wizard of Akyrz** ..... **£8.95**  
**Perseus and Andromeda** ..... **£8.95**  
**Ten Little Indians** ..... **£8.95**

### COMPUTER CONCEPTS

**Snake** ..... **£6.91**  
**Android Attack** ..... **£7.78**

We have a wide range of educational programs for use in the home as well as at school.

This is just a selection:

### ACORNSOFT

**Sentence Sequencing** (8-12 yrs) ..... **£10.35**  
**Word Sequencing** (7-12 yrs) ..... **£10.35**  
Two programs to assist in the development of English, involving the altering of words and sentences to form logical phrases within a time limit set by the supervisor. Twenty results can be stored.  
**Tree of Knowledge** (6-12 yrs) ..... **£8.65**  
Allows the building up of data about objects for the computer or child to guess.  
**Missing Signs** (8-10 yrs) ..... **£10.35**  
**Number Balance** (8-10 yrs) ..... **£10.35**  
Two mathematical programs capable of testing different levels of ability.

### BES

**World Wise** (7-15 yrs) ..... **£7.80**  
Build up information on geography and then define questions to distinguish between different entries.  
**Word Hang** (5-13 yrs) ..... **£7.80**  
Hangman, using a built vocabulary of 250 words, or add your own.  
**Animal/Vegetable/Mineral**  
(7-13 yrs) ..... **£4.95**  
Data can be stored and reused if required.  
**Happy Numbers** (4-6 yrs) ..... **£7.80**  
For young children, this program allows you to learn numbers from 1 to 9. All entries are recorded to help identify problems.  
**Timeman One** (4-6 yrs) ..... **£7.80**  
Teaches children to tell the time.

### H&H SOFTWARE

**Signals and Magic** (8-12 yrs) ..... **£8.50**  
An entertaining program to teach addition, subtraction and multiplication.  
**Early 1, 2 and 3** (5-7 yrs) ..... **£6.50**  
English programs in varying degrees of difficulty.

### MICRO POWER

**World Geography** (12-15 yrs) ..... **£5.95**  
Capitals and populations of most countries of the world.  
**Where** (12-15 yrs) ..... **£5.95**  
A geographical program to test students' knowledge of rivers, towns and mountains in Britain. The program also measures response times and gives user friendly messages throughout.







# MORE OUT OF THIS WORLD SOFTWARE FOR THE BBC MICRO AND ACORN ELECTRON FROM IJK SOFTWARE...

## CASSETTE EIGHTEEN: CATERPILLAR



Fantastic machine code version of this popular game. Base moves horizontally and vertically. Game features spider, fleas, scorpions etc. For BBC 32K £7.50 inc. Also available for Electron £7.50 inc.

## CASSETTE SEVENTEEN: 5-A-SIDE SOCCA



At last!!! The 2 player m/c game you have all been asking for. Uses joysticks or keyboard. Really exciting - pass, dribble, tackle and shoot. £7.50 inc.

## CASSETTE SIXTEEN: PONTON & PATIENCE



Excellent rendition of the two very popular card games. Psst!! red six on black seven. £7.50 inc. Also available for Electron £7.50 inc.

## CASSETTE FIFTEEN: LEAP FROG



Superbly written m/c arcade type game. Beautifully presented, features lanes travelling at different speeds, skill levels, tunes, butterflies, parrots. For use with joysticks or keyboard. £7.50 inc.

## CASSETTE FOURTEEN: STRATOBOMBER



Excellent graphics on this m/c arcade type game. Can you keep the enemy fleet at bay in order to destroy the rogue star ships nuclear reactor? £7.50 inc. Also available for Electron £7.50 inc.

## CASSETTE ELEVEN: ATLANTIS



The superb fast action m/c arcade type game. Guide your submarine Nautilus along the undersea landscape and through the caverns avoiding mines, depth charges, rockets, jelly fish, serpents etc. Features skill levels and user selected keys. £7.50 inc.

## OTHER TITLES AVAILABLE...

### MODEL A/B

**CASSETTE 1:** Star Trek/Candy Floss (very popular). £6.50 inc.

**CASSETTE 2:** Family Games (hours of fun). £4.50 inc.

**CASSETTE 3:** Mutant Invaders/Breakout. £6.50 inc.

**CASSETTE 8:** Model A Invaders (M/C). £5.50 inc.

### MODEL B (or A+32K)

**CASSETTE 4:** Beep-Beeb (Super Simon Game). £4.50 inc.

**CASSETTE 5:** Beebmunch (full colour Munchman). £6.50 inc.

**CASSETTE 6:** Super Hangman (animated, educational). £4.50 inc.

Also available for Electron £7.50 inc.

**CASSETTE 7:** 3D Maze (fast and intricate). £4.50 inc.

Also available for Electron £7.50 inc.

### CASSETTE 9:

**MODEL B Invaders (or A+32K) (M/C).** £7.50 inc.

Also available for Electron £7.50 inc.

### CASSETTE 10:

**WORDPRO.** (Cassette W.P. system). £10.50 inc.

### CASSETTE 12:

**FLAGS.** (Countries and Capitals). £4.50 inc.

Also available for Electron £7.50 inc.

### CASSETTE 13:

**HYPERDRIVE** (M/C arcade). Destroy the Drone aliens in the caverns with your laser tank. £6.50 inc.

Also available for Electron £7.50 inc.

**ALL PRICES FULLY INCLUSIVE OF VAT  
AND P&P - NO MORE TO PAY**

All advertised software is in stock NOW and will be despatched within 48 hours of receipt of order.

All Programs will run on ALL current OS versions and basic roms.

Please state computer type when ordering.



**IJK  
Software  
Limited**



**24 HOUR ANSAFONE**

Unit 3c, Moorfields, Moor Park Avenue,  
Bispham, Blackpool, Lancs FY2 0JY  
Telephone (0253) 55282





# Tower Bridge listing

From Page 55

This listing was produced using a special formatter which breaks one program line over several lines of listing. When entering a line don't press Return until you come to the next line number. Full details of the formatter are in the July issue of The Micro User.

```

10 REM *****
    *****
20 REM * TOWER BRIDGE
    GAME *
30 REM * *
40 REM * Designed by
    *
50 REM * *
60 REM * P. BIBBY *
70 REM * *
80 REM * Program by *
90 REM * *
100 REM * ZEN *
110 REM * *
120 REM * (c) 1983 *
130 REM * THE MICRO USER
    *
140 REM * *
150 REM *****
    *****
160 PROCinit
170 ON ERROR PROCerr
180 REPEAT
190 MODE 7
200 PROCinstruct
210 M%=3
    :S%=0
    :no%=1
220 REPEAT
230 MODE 1
240 VDU 23,0,8202;0;0;0;
250 PROCsetup
260 PROCscreen
270 PROCbridge
280 VDU 5
290 PROCman
300 FOR N%=0TO 2
    :PROCquard
    :NEXT
310 REPEAT
320 #FX15,1
330 IF POINT(X%+20,Y%-36)=0
    AND (X%<352OR X%<864)
    PROCfall(16,0)
340 IF POINT(X%+16,Y%-46)=1
    SOUND &11,2,20,255
    :PROCfall(3,1)
    :A%=1
350 IF POINT(X%+16,Y%-4)=1
    AND C%=1SOUND &12
    ,2,120,255
    :C%=0
    :D%=D%+1
    :VDU 4
    :PRINT TAB(30,1)" "
    :VDU 5
360 K%=INKEY (0)
    :IF K%<>-1PROCmanmove
    :C%=1
370 IF TIME MOD 800<10up%=1
    :MOVE X%,Y%+28
    :GCOL 3,3
380 IF up%PROCraise(8)
    :VDU 96
390 IF U%>1AND up%=0
    :VDU 4
    PROCraise(-8)
400 PROCthink
    :PRINT TAB(30,1)"£"
410 UNTIL T%=11 OR A%
    :VDU 5
420 IF A% PROCdead
590 IF X%=32AND Y%=323
    AND C%=1SOUND &13
    ,2,60,255
    :C%=0
    :VDU 4
    :S%=S%+10
    :PRINT TAB(30,1)" "
    TAB(T%,25)"£"TAB(14
    ,1);S%
    :VDU 5
    :T%=T%+1
600 SOUND &11,-10,120
    ,1
610 PROCman
620 ENDPROC
630 DEF PROCfall(V%,W%)
    :nc%=6
    :REPEAT
    :Y%=Y%-V%
    :PROCman
    :UNTIL POINT(X%+16
    ,Y%-36)<>W%
    :SOUND &10,-15,6,1
    :SOUND &11,0,0,0
650 DEF PROCman
660 GCOL 3,2
    :MOVE X%,Y%
    :VDU 224+nc%
670 MOVE 1x%,1y%
    :VDU 224+oc%
680 oc%=nc%
    :1x%=X%
    :1y%=Y%
690 ENDPROC
700 DEF PROCthink
710 N%=(N%+1)MOD no%
720 ON N%+1 GOSUB 820
    ,840 ,830 ,830 ,850
    ,840
730 PROCquard
740 ENDPROC
750 DEF PROCquard
760 GCOL 3,3
770 MOVE X%(N%),Y%(N%)
    :VDU 233
780 MOVE OX%(N%),OY%(N%)
    :VDU 233
790 OX%(N%)=X%(N%)
    :OY%=Y%(N%)
800 IF POINT(X%(N%)+4
    ,Y%(N%)+16)=1AND D%>0
    SOUND &13,2,20,255
    :D%=D%-1
    :MOVE X%(N%),Y%(N%)+28
    :GCOL 3,3
    :VDU 96
810 ENDPROC
820 X%(N%)=X%(N%)+32
    :IF X%(N%)>1248X%(N%)=8
    64
    :RETURN
    :
    ELSE RETURN
830 X%(N%)=X%(N%)-32
    :IF X%(N%)<416X%(N%)=83
    2
    :RETURN
    :
    ELSE RETURN
840 X%(N%)=X%(N%)-32
    :IF X%(N%)<OX%(N%)=320
    :RETURN
    :
    ELSE RETURN
850 X%(N%)=X%(N%)+32
    :IF X%(N%)>1248X%(N%)=9
    28
    :RETURN
    :
    ELSE RETURN
860 DEF PROCraise(R%)
870 IF U%>90AND R%=8up%=0
    :ENDPROC
880 PROCbridge
    :U%=U%+R%
    :PROCbridge
890 ENDPROC
900 DEF PROCbridge
910 GCOL 3,3
920 MOVE 416,444
    :DRAW 639-U%,444+U%
    :DRAW 639-U%,476+U%
    :DRAW 416,476
    :MOVE 832,444

```



## BBC FORTH

£15

"For your money you get not only a very good implementation of the popular FORTH language but also a 72 page manual... Once you have got an idea of the fundamentals you should get better value out of this pack than virtually any other program you could buy. In fact, the only reason I can think of for not buying this cassette is that you already have a version of FORTH!" - *LASERBUG April 83*

"rqFORTH is fast and has a first-class screen editor... Overall, a good buy" - *Computing Today July 83*

rqFORTH costs just £15 (inclusive) and runs on 16K or 32K BBC micros. It:

- ★ needs no added hardware and works with any MOS version;
- ★ works with cassette and disc;
- ★ is FORTH-79 STANDARD and has fig-FORTH facilities;
- ★ provides 260 FORTH words and is infinitely extensible;
- ★ allows full use of the MOS via \*MOS, CALL and EMIT;
- ★ permits use of all graphic modes, even 0-2 (just!);
- ★ has an excellent full-screen editor;
- ★ runs faster than BBC BASIC;
- ★ includes a 72 page manual, a 20 page disc supplement and a summary card for quick reference;
- ★ is used by hundreds of people, worldwide.

## BBC FORTH TOOLKIT

£10

"Level 9 promise to support rqFORTH and this pack proves it. It provides the source code for all sorts of useful routines and examples of how to program in FORTH. With so much on one cassette it would be good value at twice the price." - *LASERBUG April 83*

The rqFORTH toolkit costs just £10 (inclusive) and adds the following facilities to FORTH:

- ★ a full assembler, providing machine-code within FORTH;
- ★ turtle graphics, giving you easy-to-use colour graphics;
- ★ decompiler routines, allowing the versatile examination of your compiled FORTH programs;
- ★ the full double-number set (with many extensions);
- ★ an example FORTH program and demonstrations of graphics;
- ★ other useful routines.

ALL PRICES INCLUDE P&P AND VAT. ALL programs are in stock and orders will be sent within 2 days of receipt. Please send order or SAE for catalogue, describing your micro, to:

### LEVEL 9 COMPUTING

Dept U, 229 Hughenden Road, High Wycombe, Bucks HP13 5PG

## Learning a Language ?

Kosmos  
Software

BBC  
Micro  
Model B

A French Language  
Learning Aid.



Kosmos  
Software

BBC  
Micro  
Model B

A German Language  
Learning Aid.



- ★ For Pupils, Teachers, Travellers or anyone interested in languages.
- ★ Ready made lessons provide an enormous vocabulary of words, phrases and verbs arranged in subject groups.
- ★ Lessons can be run in three ways; learning, self-test or speed and accuracy test. Clear, large-format displays including all special characters; each gender has its own colour.
- ★ Full tape editing facilities allow an infinite number of new or updated lessons to be created and stored for later use.
- ★ Runs on all operating systems including systems fitted with disc.

Choice of Level A or B cassettes with totally different vocabularies. Both include extensive word lists; verbs and phrases are introduced in Level B. Available from dealers, large stores or mail order. Prices include p&p.

French Level A or B £9.95 each  
German Level A or B £9.95 each  
Also available: Spectrum 48K French  
Available soon: The Spanish Tutor

KOSMOS

### SOFTWARE

1, Pilgrims Close, Harlington  
Dunstable, Beds. LU5 6LX  
Tel: 05255 3942

Authorised Dealer & Service Centre  
IN

# MID-SUSSEX



**BBC**  
MICRO COMPUTER



- **HARDWARE**  
BBC B's & wide range of Monitors,  
Printers, Disc Drives
- **SERVICING/UPGRADING**  
On site Engineering
- **SOFTWARE** Variety of Educational/  
Games/Business Packages
- **COURSES** Beginners  
& upwards on BBC  
Micro from £15.00.  
Day/Evening.  
Children/Adults

PHONE  
BURGESS HILL  
(04446)

**41441**

Visit our New Computer Store



**michael**  
Business Systems Ltd

195 LONDON ROAD BURGESS HILL SUSSEX

## ★ GRAPHICS MADE EASY ★

Now anyone can draw and write on the screen as easily as on paper.

You can quickly produce a sequence of pictures or text, and move from one 'page' to another at the touch of a key. Ideal for writing your own educational programs, even without programming knowledge.

Works through the keyboard and allows you to draw lines, boxes, circles, ellipses, etc., in any colour and in any graphics mode. Pictures can be saved on tape and redrawn when needed.

Already in use in schools, colleges and universities.

**EXCELLENT VALUE AT ONLY  
£13.50 inc. P&P**

includes Easy Graphics cassette, demonstration program, program generator (allows you to redraw your pictures), and full instructions. All programs guaranteed to load. (BBC 32K only)

Please supply ..... copies of Easy Graphics. I enclose my cheque or postal order for £ ..... (price £13.50 inclusive), payable to Hexagon Software.

Name .....

Address .....

Please send completed form to:

## HEXAGON SOFTWARE

17, Straits Road, Gornal, Dudley, West Midlands, DY3 2UR. Tel: (0384) 232992.



## Tower Bridge listing

From Page 127

```

:DRAW 640+UZ,444+UZ
:DRAW 640+UZ,476+UZ
:DRAW 832,476
930 ENDPROC
940 DEF PROCscreen
950 VDU 19,1,4;0;19,2
,2;0;19,3,3;0;
960 COLOUR 130
:VDU 28,0,31,39,29
,12
:COLOUR 129
:VDU 28,0,2,39,0,12
,26
970 COLOUR 128
:PRINT TAB(8,1)"Score:"
;SZTAB(24,1)"Cargo:"
"TAB(16,30)"Level:";no%
980 PROCtower(10,4)
990 ENDPROC
1000 DEF PROCtower(AZ,BZ)
1010 LOCAL XZ,YZ
1020 COLOUR 129
:VDU 28,13,25,25,23
,12
:COLOUR 130
:VDU 28,0,25,12,23
,12,28,26,25,39,23
,12,26
1030 COLOUR 128
1040 FOR XZ=0TO 2
:FOR YZ=0TO 18
1050 PRINT TAB(XZ+AZ,YZ+BZ)
CHR$(224);TAB(XZ+16+AZ
,YZ+BZ)CHR$(224)
1060 NEXT YZ
:NEXT XZ
1070 COLOUR 1
:FOR XZ=9TO 29
:PRINT TAB(XZ,6)
CHR$(232)
:NEXT
1080 COLOUR 131
:VDU 28,0,17,12,17
,12,28,27,17,39,17
,12,26
:COLOUR 128
1090 FOR YZ=4TO 22
:PRINT TAB(11,YZ)
CHR$(225);TAB(27
,YZ)CHR$(225)
:NEXT
1100 VDU 4
:COLOUR 129
:COLOUR 2
:PRINT TAB(1,15)"£"
TAB(38,21)"£"TAB(38
,15)"£"TAB(14,4)"£"
TAB(24,4)"£"TAB(14
,15)"£"TAB(8,15)"£"
TAB(30,15)"£"TAB(24
,15)"£"TAB(30,21)"£"
TAB(8,21)"£"TAB(0
,20)"Bank"
1110 COLOUR 3
:PRINT TAB(0,1)
STRING$(MZ,CHR$(226))
:COLOUR 128
1120 ENDPROC
1130 DEF PROChead
1140 FOR nZ=0TO 1
:PRINT TAB(10,0+nZ)
CHR$(157)CHR$(132)
CHR$(141)"Tower Bridge
"CHR$(156)
:NEXT
1150 PRINT TAB(14,3)
CHR$(130)CHR$(136)
"by ZEN"TAB(16,5)"HI:";
hiZ
1160 ENDPROC
1170 DEF PROCinstruct
1180 PROChead
1190 PRINT TAB(14,10)
CHR$(131)"A = Up"
TAB(14,13)CHR$(131)
"Z = Down"TAB(14
,16)CHR$(131)"< =
Left"TAB(14,19)
CHR$(131)"> = Right"
1200 PRINT TAB(0,24)"<RETURN
> for INSTRUCTIONS
<SPC> to PLAY";
1210 *FX15,1
1220 REPEAT G=GET
:UNTIL G=32 OR G=13
1230 IF G=13 PROCTell
1240 ENDPROC
1250 DEF PROCTell
1260 CLS
:PROChead
:PRINT "As custodian
of the Tower of London
you" "are rather supri
sed one night when
the" "treasures vanish
They were taken by
the Tower ghosts.
Your job is to get"
"them all back to the";
1270 PRINT " bank. To collec
t a treasure all you
have to do is run
underthe ""£"" signs.
The treasure will
then beaded to the
cargo display. By
running""into the
bank you can deposit
your loot.";
1280 PRINT "The ghosts canno
t kill you but if they"
"catch you while you
are carrying a""treas
ure the will almost
certainly ""steal
it back and stash
it somewhere""else.
Each time you complete
a wave the next one
have more ghosts."
1290 PRINT "Watch out for
the BRIDGE and the
THAMES";
1300 PRINT TAB(10,24)"Press
<SPC> to PLAY";
1310 *FX15,1
1320 REPEAT UNTIL 32=
GET
:ENDPROC
1330 DEF PROCinit
1340 DIM XZ(5),YZ(5),OZX(5)
,OYZ(5)
:hiZ=300
1350 *FX12,1
1360 *FX11,1
1370 ENVELOPE 1,0,-2,0
,0,200,0,0,127,0,0
,0,126,0
1380 ENVELOPE 2,0,-230
,230,-230,5,5,5,127
,-1,0,0,126,0
1390 VDU 23,224,&B6,&B6
,0,&5B,&5B,0,&B6,&B6
1400 VDU 23,225,&FF,&81
,&81,&81,&FF,&81,&81
,&81
1410 VDU 23,226,24,24,16
,254,16,28,116,70
1420 VDU 23,227,24,24,16
,254,16,208,112,24
1430 VDU 23,228,24,24,8
,127,8,11,14,24
1440 VDU 23,229,24,24,8
,127,8,56,46,98
1450 VDU 23,230,90,90,126
,24,24,126,66,66
1460 VDU 23,231,0,0,0,255
,255,126,126,60
1470 VDU 23,232,255,129
,131,133,137,145,161
,255
1480 VDU 23,233,24,60,90
,255,219,66,126,36
1490 ENDPROC
1500 DEF PROCsetup
1510 lxZ=-32
:lyZ=-32
:lxZ=32
:lyZ=323
:ocZ=3
:ncZ=3
:zZ=3
:Uz=1
:AZ=0
:CZ=0
:DZ=0
:upZ=0
1520 XZ(0)=1280
: XZ(1)=-32
: XZ(2)=1280
: YZ(0)=323
: YZ(1)=515
: YZ(2)=867
1530 XZ(3)=1280
: XZ(4)=-32
: XZ(5)=-32
: YZ(3)=515
: YZ(4)=515
: YZ(5)=323
: TZ=0
1540 FOR NZ=0TO 5
:OXZ(NZ)=XZ(NZ)
:OYZ(NZ)=YZ(NZ)
:NEXT
1550 ENDPROC
1560 DEF PROCerr
:IF ERR =17ENDPROC
1570 *FX12,0
1580 *FX12,3
1590 VDU 4
:REPORT
:PRINT " In line "ERL
1600 END

```

This listing is included in this month's cassette tape offer. See order form on Page 99.



SWIFT MACHINE SOFTWARE

**SMS**

BBC  
32K  
All O.S.'s

**WE LIKE COMPUTER GAMES!**

**BUT DON'T YOU THINK THAT SPENDING £399 ON A COMPUTER JUST TO PLAY GAMES IS A WASTE OF A SUPERB MACHINE?**

Our range of software packages has been developed to be used both at home and in school. SMS packages form a comprehensive library of educational information, incorporating not only a wealth of data, but also the facility to test yourself against the computer.

**SWIFT DATABANK PACKAGES.** Each package contains THREE individual programs which all provide a rapid research and data-read facility.

SWIFT 1. Great Scientists, Great People in Medicine, Men of Invention and Technology.

SWIFT 2. Kings and Queens of England, Prime Ministers of Britain, Great Explorers.

SWIFT 3. 20th Century Leaders, Great Soldiers in History, Great Rulers in World History.

SWIFT 4. Great Composers of the World, Great Writers of the World, Great Artists and Sculptors.

SWIFT 5. World Gazetteer, Periodic Table of Elements, Minerals of the World.

**SWIFT "O" LEVEL HISTORY REVISION PACKAGES.** Each package contains TWO individual programs providing text and test facility, with colour graphics and bar charts.

SWIFT 6. Hitler's Germany 1933-1939, Mussolini's Italy 1919-1939.

SWIFT 7. Lenin's Russia 1917-1918, Stalin's Russia 1924-1939.

**SWIFT READER FLASH CARD SYSTEM.**

SWIFT 8. A suite of EIGHT programs to help young children learn to read, from basic letter recognition to the reading of a simple story; incorporating a variable speed text read-out. (Non Graphic).

MORE PACKAGES COMING SOON

DEALER AND EDUCATIONAL ESTABLISHMENT ENQUIRIES WELCOME.

All packages are available on cassette at £9.95 per tape, or SS/SD 40 track disc at £11.95 per disc, both prices include VAT & P&P.

SEND CHEQUE/P.O. WITH DETAILS OF TAPES/DISCS REQUIRED TO:

**SWIFT MACHINE SOFTWARE, 154 GREENFIELD RD., HOLMFIRTH, W. YORKS. HD7 1LP.**

★ Swift Programs for the Swift Machine ★

**SIMONSOFT**

Quality BBC Software  
BUY NOW while our prices are SUPER-LOW

... only £5.95!

**Fruit Machine**

BRILLIANT graphics make this game truly life-like. Includes spinning reels with "bounce", hold, gamble, swap reels, nudge, nudge gambles and clever sound effects. Number of spins displayed. Watch your coin pile shrink or grow - can you bust the computer or will you yourself become "skint"? BEST fruit machine game out. (32K)

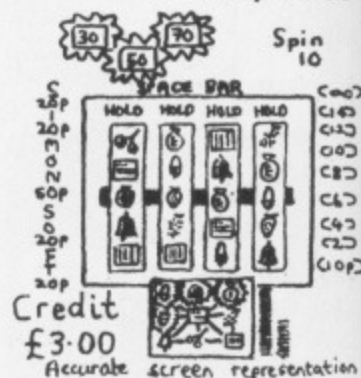

**The Memory Game**

... only £5.95!

IMPROVE your short term memory! GREAT family game. Match up 32 pairs of high quality, Mode 2 pictures. Remember which cards are where - and next turn you win a pair. Program is all highly compact machine code. Pictures ranging from a butterfly to an airliner; instructions, ratings, placings etc. all displayed + imaginative jingles enhance super game. 1-6 players. (32K)



**SIMONSOFT SPRITES**

only £10.95!

48 multicoloured, animated, user-defined sprites controlled from your own BASIC programs! Superfast compact machine code brings you arcade-speed sprites. This sprite routine deletes "old" sprites and resets variables so that sprites can cross screen boundaries automatically. Two separate images in each sprite allows animation. Routine merges with BASIC so that you can SAVE/LOAD your program as a whole. Includes sprite definition program, user manual, demo. games. Invaluable to serious BASIC programmers. (32K)

Simonsoft pays 35% royalties for top quality programs.

Prompt delivery guaranteed.

Write to:

**SIMONSOFT, 25 Tatham Road, Abingdon, Oxon, OX14 1QB.**

**NEWARK VIDEO CENTRE PRESENTS**

**SUPER CLEAR COMPUTER DISPLAY - AND A TV!!!**

AN RGB MONITOR - WITH TV RECEPTION

14 1/2" A2105/RGB £275.00 - 20" B6100/RGB £365.00

16" B3104/RGB £299.00 - 22" C7100/RGB £399.00

16" B3404/RGB with Remote Control & Teletext Option £350.00

26" B8400/RGB with Remote Control & Teletext Option £465.00

All prices include VAT, a 12 month guarantee, a 6 pin DIN lead, a mains plug and carriage to your door. All are Grundig TV's supplied with Grundigs consent. Educational and quantity discounts are available.

What 'What Micro' said:

"The colours are just unreal like the 'simulated' pictures in TV advertisements". "The best of all images came from this set".

"A very reasonable comparison could be made with colour monitors costing several hundreds of pounds".

**STOP PRESS** - New 14" Remote Control £299.00

**NEW!** 1 input-6 output RGBS Distribution Amplifier - £250.

For details of the full range contact:-

**NEWARK VIDEO CENTRE LTD.**

**108 LONDON ROAD, BALDERTON, NEWARK, NOTTS. TEL: 0636 71475**

OPEN 9am - 6pm Mon-Sat.

Visa card available.

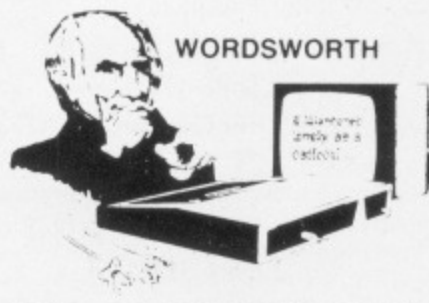

WORDSWORTH

NOW ON  
DISC  
OR  
TAPE

**A BBC WORD-PROCESSOR**

FOR HOME, SCHOOL, COLLEGE OR BUSINESS WITH

- \* BACKGROUND PRINTING \* ON-SCREEN FORMATTING \*
- \* DECIMAL TAB WITH AUTOMATIC TOTALLING \*
- \* DEFINABLE PRINTER CONTROL CODES \*

Print 500 labels, personalise 500 letters, or print 200,000 characters at one command - with up to 9999 copies of everything. Or use it without a printer for your address lists, appointments diary, indexes etc.

**IT MUST BE**

**WORDSWORTH**

TAPE £17.25. DISC (40 OR 80 TRACK) £19.50  
FROM YOUR DEALER, OR DIRECT FROM

**IAN COPESTAKE**

Dept. W13, 23 Connaught crescent, Brookwood, WOKING, Surrey, GU24 0AN Tel. 048 67 Brookwood 4755

Goods despatched by return Printing service available



THREE cheers for Christopher Hester, who in October's Micromail exposed the naked king of over-precious structured programming!

What in the world is so sacrosanct about a PROC? Why the lumbering PROC . . . DEFPROC . . . ENDPROC when a plain honest GOSUB . . . RETURN does the job in half the time, is easily traceable and is just as readily debuggable?

Your program structure shouldn't suffer a whit by a GOSUB: GOSUBs are quick and nimble, whereas PROCs are heavy, fat and sanctimonious.

The only advantage in using PROCs lies in their control variable facility, and if you don't want a control variable (as most people don't) then why leave the nippy GOSUB languishing, discredited, in the wings?

And while we're on the subject, why all this pious claptrap about using TRUE and FALSE, when a simple 1 or 0 flag is far more easy to use?

Or at least it would be if the Acorn compilers were not so waywardly silly as to insist on a -1 value for TRUE, thus denying us the quick and easy IF x . . . and IF NOT x . . . clauses.

These poor brainwashed Beeb programmers have been misled into considering it a point of honour not to include a single GOTO or GOSUB in their listings.

What a pathetically self-righteous and hypocritical attitude! We are interested in what programs DO, not in delivering pats on the head for the handwriting. - David Bye, Saffron Walden, Essex.

## Squaring things up

I HAVE bought your magazine since it first appeared, and have found it very helpful.

So perhaps I can help some

## No plaudits for handwriting . . .

of your readers with the problem of "NO ROOM" in the King Kong and Deathwatch programs. I also fell into the trap of creating unwanted spaces that took up memory. I then obtained the following short program that will list all extra spaces including the essential ones.

First list your program to screen and then type the following:

```
MODE6:VDU19,0,1,0,0,0:VDU23,
32,255,255,255,255,255,255,2
55,255
```

Then press Return. The listing starting at the beginning will now appear with squares making the spaces and all unwanted ones can be removed by the aid of the copy key.

You will be amazed at the number of spaces that creep in and are not required. - S.H. Gereham, Romford.

## Lost programs

I HAVE several enquiries which I hope you may be able to answer. They are all intriguing and could well be of interest to other readers.

The first problem arose when I bought for my school a piece of software which I spent the whole weekend trying to list. It loaded all right and then ran. (I typed LOAD, etc rather than CHAIN.)

When I typed LIST, the screen went blank. I used an assembly language retrieval program - nothing.

I tried to list only certain sections - nothing. I tried to delete certain lines - nothing.

Eventually the program was lost and I reloaded it.

After abortive attempts to list, anything I pressed gave "Bad Program". What intrigues me is how they do it? I want to learn rather than infringe copyright!

Secondly, I have heard that transferring programs from cassette to disc can be awkward. I should think that for long programs, needing to be loaded at &E00, it would prove rather difficult. So how is it done?

Thirdly, I read often that certain memory locations contain certain information. How can I find out what's where?

For example, in the November issue, one of your correspondents writes that information on which mode one is in is contained in location &367. How can you find out these things?

Lastly, could you explain what VDU23 does - apart from turning the cursor on and off and re-programming display characters.

Then again, what about VDU23,9;16;0;0; or whatever?

Could we have a comprehensive list of all possible VDU23 commands?

Oh yes - what about an article on GCOL1, 2 & 3!

Needless to say, an excellent magazine. - Graham Conridge, London.

● The software protection method you describe is caused by entering control codes into REM statements. For obvious reasons we cannot give more details.

The problems of transferring cassette to disc were fully covered in Peter Walker's article in the August issue of Micro User.

I suggest the Advanced User Guide and our back issues as sources of information on memory locations, and also on VDU23.

This command can be used in two ways to create user defined characters, or to directly program the 6845 - details of which we shall be giving in forthcoming articles.

We're also going to feature soon the uses of GCOL 1, 2 and 3.

## rqForth

I WAS delighted to find Chris Martin's lengthy review of Level 9's rqForth in your November issue and was glad that he seems to like it (once I'd tracked down his opinions among the inevitable paragraphs on Forth history, etc!).

Readers may be interested to learn that all copies of rqForth sold since Easter have included versions for both cassette and disc (with a free 30 page disc supplement in addition to the normal manual). - Pete Austin, High Wycombe.

## Skeleton unearthed

AFTER reading about Acorn's most generous advice to its rival software houses about indirectly addressing the screen and how this programming activity will lead to incompatibility with the second processor (if it ever arrives, that is), I was wondering how Acornsoft managed to obtain the speed required for their Super Invaders.

After many long nights bent







```

10DEFPROCpron
20CLS
30FORA=11TO12
40PRINTTAB(12,A)CHR$141CHR$134CHR$136"Printing"
50NEXT
60VDU28,0;0;:REM Zero Text Window
70VDU2
80VDU23,1,0;0;0;:REM Switch off cursor
90ENDPROC
120DEFPROCproff
130VDU3
140VDU26:REM Restore Text Window
150VDU23,1,1;0;0;:REM Restore cursor
160CLS
170ENDPROC

```

Listing I

simply enter PROCpron or PROCproff instead of VDU2 or VDU3. (Listing I.)

For anyone who already has a large program and does not wish to edit all the VDU2 and VDU3 calls, I also enclose a

```

10A%=?&20E+256*?&20F
20FORA=0TO1
30P%=&D01
40LOPTA
50CMP#2
60BNE#next
70LDA#12:JSRA#
80LDA#28:JSRA#
90LDA#0:JSRA#:JSRA#:JSRA#
:JSRA#
100LDA#2:JSRA#
110.next
120CMP#3
130BNE#none
140LDA#3:JSRA#
150LDA#26
160.none
170JMPA#
180]
190NEXT

```

Listing II

machine code patch which will detect any VDU2 call, clear the screen and set up a zero text window. (Listing II.)

A VDU3 call will reset the text window to the default. The patch is presently assembled at &D01.

Anyone with a disc drive will need to use another section of RAM. To activate the patch use ?&20E =1 : ?&20F=&D. In this case the cursor remains, although it could be removed with extra lines of code if required.

BREAK will deactivate the patch, as will POKEing the original contents back into &20E and &20F. These values may vary for different operating systems, and should be determined for individual machines. Incidentally, if storing the program anywhere other than &D01, the activation addresses should be changed accordingly. — Peter Vasey, South Shields.

## Tiny Problem

HERE is our computer game idea: The computer is the dog and you are the frog.

The dog chases the frog, but you can get away by jumping over the dog and score points by jumping on a lily pad — about 100 points. You have four lives.

It has three screens and on each screen there gets less and less lily pads. On the third lot you have three lily pads — two green and one red which is home and scores 500 points.

You have 1000 units of energy to get through each lot.

We do not know how to write this game in Basic. Please could someone do it for us? — Sharon King, age 8½, Paul King, age 6½.

● Is there anyone out there who could program Sharon and Paul's idea for them? If so, get in touch with Micro User!

## Structure strictures

MAY I reply to Christopher Hester's points and questions about structured programming (Micro User, October, 1983).

First, a general point. BBC Basic is not fully structured and it is true that complete adherence to the rules of good structure produces more procedures than one would choose.

I can give details of methods for getting the procedures in a reasonable order, perhaps soon in this journal. But at least when searching for a procedure one is searching for a properly named chunk of code with a beginning and end.

Most of Mr Hester's problems arise because of faults in BBC Basic which one hopes are just part of the long history of the development of languages.

A change of graphics mode should be possible in a procedure. It is a problem the software writers did not solve properly. The same comment applies to any other action command. They should work in procedures or in the main program equally well.

The reasons why GOTO and GOSUB are still included are complex and different. GOSUB is there for compatibility with old practices and possibly as a cover for technical shortcomings.

No modern language would be designed with GOSUB included for its own sake.

GOTO has the same justifications and one more. There are certain complex situations, such as the need to cope with an error discovered at a deeply nested point in a program, when a GOTO is the simplest way to cope. Used carefully by an expert there is no problem.

But as a teacher I know from bitter experience the trouble which GOTO causes.

For students and beginners it should be completely avoided and even Mr Hester need not use it for the input routine he mentions. A standard structure for handling keyboard input is:

```

REPEAT
  (get the data)
UNTIL (data is correct)

```

It would be easy for people to list their personal preferences but the concepts of SP are the result of wide consensus and more than a decade of hard won progress.

BBC Basic is good enough (only just) to enable its users to work in a sensible modern conceptual framework within which problems can be solved and tasks completed in efficient, readable ways.

Any reader is free to reject or accept this philosophy, but I do get upset when I see the old discredited methods being taught to unsuspecting children or other newcomers to computing. Why does Mr Hester think SP was invented? — Roy Atherton, Director, Bulmershe Computer Education Centre, Reading.

## Answer in stereo

READING of the continuing interest in tape loading problems I thought that some readers might benefit if I related my own experiences in this troublesome area.

For my first attempts at tape loading I used my "quality" mains powered stereo tape deck with built in amplifier (output impedance 10kohms, input 560 kohms).

Acorn's letter in the October issue of Micro User showed that I had no chance of success. I then bought a cheap portable and now, being as wise as the Beeb Owl, asked for a demo to be sure that it worked.

The dealer promptly loaded up Planetoids — no problem.



# MICROMAIL

## From Page 133

On my return home however I discovered that there was no record level control and the auto level was too high. Programs unloaded to tape could not be loaded back onto the computer.

My way round that one was to re-record onto my mains recorder adjusting the record level appropriately.

Well, as you might guess all this infuriated my wife. The tape deck went back to the dealer and we bought a pair of disc drives.

If you promise to keep a secret from more understanding wives I have now discovered that if I record onto the stereo deck via the microphone input (low impedance) and carefully output via the speaker channels (6w) there's no trouble at all!

It's just as well Acorn were

a little slow in writing to you. —  
Lex Harrison, Edinburgh.

## Missing

THANKS for a great magazine but in your listing for your date of birth program in the October issue you missed a line out and the program would not run. There should have been a line number 35 PROCinit. —  
Matthew Searle, age 11.

● Quite correct Matthew — the missing line is on the floor somewhere in our art room!

## Mystery

CAN you help me with two problems?

Why does shift and break produce the message:

```
BBC Computer
Searching
File not Found
BASIC
>_
```

While disassembling the Basic I ROM I found the command LINE. Could you please tell me what this does? —  
Ben Dessau, Rottingdean.

● On machines fitted with a DFS, pressing break and shift, then releasing break while maintaining shift causes the micro to \*EXEC a file on the disc with the title !BOOT (provided the disc has been prepared with \*OPT 4 3).

Often !BOOT simply chains in a menu program.

If you haven't got a DFS, you obtain the message you described on OS1.2. On OS0.1 you simply obtain a normal break.

\*LINE and \*CODE allow you to jump to your own machine code routine pointed at by a vector at &200,&201 (the user vector USERV).

\*CODE is followed by two parameters which are placed in the X and Y registers. It is entered with the accumulator

equal to zero.

\*LINE is followed by a string, the start of which is vectored by X and Y. It is entered with the accumulator equal to 1.

## Crash catcher

TO make your BBC Micro print the line at which an error occurs when it crashes, the following can be used (with OS 1.0 or later):

```
10 ON ERROR REPORT:PRINT"
at line";ERL: PROCinsert("L
IST"+STR$(ERL)+CHR$13):STOP
10000 DEFPROCinsert(I$):REPE
AT:AZ=138:YZ=0:YZ=ASC(LEFT$(
I$,1)):CALL&FFF4:I$=RIGHT$(I
$,LEN(I$)-1):UNTIL I$="":END
PROC
```

— David Stonebanks, Stevenage.

And finally, with tongue firmly in cheek . . .

## Trevor's micro finally makes the grade . . .

Dear Trev,

I've finally done it. I've summoned up the nerve to take my micro down to the Nice Byte and get my new ROM fitted. So, instead of being just a 0.1 plebian, I am now the proud owner of a 1.2 Operating System.

Mind you, it was a nerve wracking experience. First of all I had to get my Beeb downstairs to the car. This entailed a half hour struggle with the tangle of wires and flexes that had built up over the past six months. It was while I was doing this that I came across a plug that actually didn't do anything! I've no idea how it got there or what it was supposed to do.

Andrea was nice enough to drive me and my Beeb down to the shop though she couldn't help showing her nature. By habit I sat in the front of the car.

"Shouldn't you be sitting in the back, dear?" she asked with an air of innocence. "I mean didn't they just change the law or something?"

I ignored the remark and she referred

to my British Broadcasting Micro as "the little bundle" all day.

When I got to the Nice Byte she came in with me and demanded that the salesman explain exactly what was going to happen. He waxed eloquent and made it sound like a brain transplant.

"Never mind the micro", she said pointing at me, "give him a new ROM".

The salesman gave me a fellow sufferer kind of look and told me that if I waited it would be "all over" in 10 minutes.

Well, it was the longest ten minutes of my life. I swear that as soon as my micro disappeared into the back of the shop I started having withdrawal symptoms. You know, anxiety, blurred vision, sweating. Without thinking about it I started pacing up and down.

"Don't worry, dear, I'm sure that they'll use an anaesthetic", Andrea murmured, working her way through the books, complaining about the prices.

It was a relief when my micro arrived back on the counter.

"Is it a boy or a girl?" Andrea asked the confused assistant.

"It's an OS 1.2 and that'll be £11", he replied.

At this point Andrea, who hadn't realised that I was going to have to pay, started to become a cross between M. Thatcher and H. Ogden, both at their best (or do I mean worst). I can't remember exactly what it was that she said (I was in a corner pretending to look at some software).

I do, however, distinctly remember her mentioning the "Sale of Goods Act, 1893" and Esther Ransom in the same breath.

Anyway, it did no good. I took out my cheque book and paid. As I walked out of the door the salesman grinned wickedly and yelled out: "See you when you get Basic Two".

Andrea's still asking me just what Basic Two is and I'm running out of lies. I wish that I'd stayed with my 0.1 ROM. I enjoyed playing the cassette bugs fix!

Yours in adversity,

Bob



## LOW COST — HIGH QUALITY

The beginnings of a new range of programs from CompuSoft. After our success in becoming the major source of Software for the Exidy Sorcerer in the UK, CompuSoft is now turning its attention to the BBC microcomputer software marketplace. Our first releases are as follows:-

CS1 - TOCCATA. Music with a difference. Almost 9 minutes worth of BACH for only £2.99. Most of the current musical programs around at this time leave you looking at a blank screen whilst the music plays. But not TOCCATA. A high resolution, multicolour, graphical representation of the music flows across the screen as it plays. For the first time you can actually see the 'shape' of the music.

CS2 - BANDIT. At last! A good quality slot machine program at a realistic price. For only £2.99 you will receive a one arm bandit program with all the features of the pub machines. This one has many win modes that coupled with the random application of holds gives this game the big machine feel. After you have won you then go on to gamble or collect. If you win on the gamble you progress to the BANDIT feature to possibly win yet more money. Of course you are given the nudge facility, excellent colour graphics and full sound effects. The only thing you do not get is real money.

CS3 - NURSERY RHYMES. Especially for the very young members of the family. This suite of programs is designed for the pre-school child. The nursery rhyme tune is played with the words appearing across the top of the screen two lines at a time whilst a full colour animated picture is displayed. The colours can be changed by pressing the function keys. Five rhymes are provided, Hickory Dickory Dock, Polly put the kettle on. See Saw Margery Daw, Humpty Dumpty and Ba Ba Black Sheep - all for £2.99

All the above programs are available for £2.99 inc. VAT and post and packing from.

**CompuSoft Ltd**

32 Watchyard Lane Formby  
Nr Liverpool L37 3JU

## A SUPERB HARD COVER for your BBC Micro

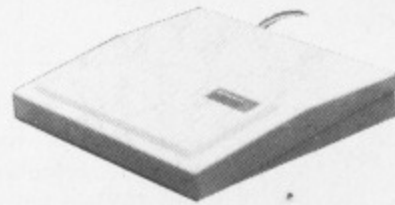

**£10.95**  
(VAT included)  
+ £1.55  
Post & Packing  
per cover

- ★ ENGINEERED IN TOP QUALITY HIGH IMPACT RIGID ABS. - VERY TOUGH
- ★ SUPER TEXTURED FINISH IN CREAM TO TONE WITH YOUR BBC MICRO
- ★ LOOKS GOOD IN THE HOME
- ★ CUSHIONED ON FOAM PADS
- ★ GIVES OPTIMUM PROTECTION
- ★ IDEAL FOR SCHOOLS

Please send me ..... covers for the BBC Micro.

I enclose a cheque/P.O. for £ .....

Name .....

Address .....

..... Code .....

Please allow 21 days for delivery.

Send to:

**GRANGE CLOSE  
SANDBACH  
CHES.  
CW11 9ET.  
B12**

**tekform**

# RED SHIFT Apocalypse

A GAME OF STRATEGY

The leading game (APOCALYPSE) has four different maps, on any one of which you may fight your war (see section A). An additional tape which contains a further six maps may also be added to expand your atlas (see section B). Alternatively, you can be NERO in the FALL OF ROME or Napoleon's right hand man in NAPOLEON'S CAMPAIGN 1813 (see section C). Can you survive the war of 1984 or could you lead your marines from island to island in the PACIFIC WAR? (see section D)

**A.**  
**APOCALYPSE**  
For: Spectrum 48K  
BBC Model B  
Available from local shop  
or by mail order  
**£9.95 inc VAT & p&p.**

**B.**  
**VOLUME 1: NOVAMAPS**  
Six new maps:  
USA: ARCTIC CIRCLE  
S.E. ASIA: STAR SYSTEMS  
S. AFRICA: NETHER EARTH

**C.**  
**VOLUME 2: CHAPTER 1**  
FALL OF ROME  
NAPOLEON'S CAMPAIGNS  
1813

**D.**  
**VOLUME 2: CHAPTER 2**  
1984 THE PACIFIC WAR  
Expansion Kits for  
Spectrum 48K (only  
B,C & D)  
**£4.95 each inc. VAT & p&p.**

Microdrive available by negotiation



**RED SHIFT LTD**  
12c Manor Road, Stoke Newington, N.16.  
**TEL: (01) 800 1333**

Apocalypse is produced under licence from The Games Workshop Ltd.



GAMES  
WORKSHOP

**PLAY IT  
BEFORE  
YOU'RE  
IN IT!**

**XMAS SPECIAL**  
Buy all four tapes  
and we will only  
charge you £20.  
Inc VAT & p&p.

### HOW TO ORDER:

You may purchase any of the items listed by cheque or postal order. All you have to do is fill in the details on the coupon below. Post to us and we will despatch within 7 to 28 days. All VAT and p & p charges are covered in the price.

**POST TO: RED SHIFT LTD,  
12c MANOR ROAD, STOKE NEWINGTON N16**

I enclose cheque/P.O. for £ .....

I would like to purchase item(s)  
(Please circle item required)

**A B C D**

\* I prefer to take advantage of your Xmas bargain at the Special Price of £20 inc VAT and p&p.

NAME .....

ADDRESS .....

All requirements can be met within 28 days.

BBCM-1



## From Page 75

```

10 REM (c) MICRO USER 1983
20 VDU 23,240,1,0,0,0,1,1,60,114
  ,23,241,72,200,80,112,208,240
  ,115,4,23,242,0,0,15,17,33,194
  ,4,2,23,243,0,0,128,0,0,0,0
  ,0,23,244,241,112,62,3,0,0,0
  ,0,23,245,248,0,31,255,63,15
  ,7,3,23,246,2,4,248,192,192
  ,128,192,248
30 VDU 23,224,64,172,84,16,16,255
  ,16,16,23,225,0,0,0,239,239
  ,0,239,239,23,226,0,3,30,126
  ,31,0,0,0,23,227,126,255,66
  ,66,255,255,90,0,23,228,0,192
  ,120,126,248,0,0,0,23,229,0
  ,0,1,3,6,14,25,54,23,230,112
  ,224,128,196,238,52,8,168
40 VDU 23,231,35,3,3,3,15,123
  ,195,23,232,88,160,0,0,0,192
  ,60,6,23,233,42,19,10,12,62
  ,246,255,15,23,234,128,0,0,0
  ,0,0,0,252,23,235,7,7,7,15,19
  ,34,4,8,23,236,255,255,254,54
  ,27,9,18,36,23,237,0,56,37,61
  ,37,37,56,0
50 VDU 23,238,0,198,41,41,41,41
  ,198,0,23,239,0,68,124,84,84
  ,68,68,0
60 VDU 23,247,60,60,60,24,126,189
  ,189,60,23,248,0,119,68,70,84
  ,119,0,0,23,249,0,119,37,37
  ,37,39,0,0,23,250,0,119,68,102
  ,68,68,0,0
70 DIM HOZ(4)
  :DIM HI$(4)
  :DIM HI$(4)
  :FOR NZ=0 TO 4
  :HI$(NZ)="BBC"
  :HI$(NZ,1)=100
  :NEXT
80 ON ERROR GOTO 910
90 PROCINSTRUCTIONS
100 ENVELOPE 1,1,-1,-1,-1,100,100
  ,100,0,0,0,-1,VIZ,0
  :ENVELOPE 2,1,0,0,0,10,10,10
  ,-1,-1,-1,-1,VIZ,0
  :ENVELOPE 3,1,0,0,0,1,1,1,-1
  ,-1,-1,-3,VIZ,0
110 MODE 1
  :VDU 5,23;8202;0;0;0;
120 SCZ=0
  :DELZ=0
  :TPZ=0
  :COZ=FALSE
  :BAPRESZ=20
  :MILOCZ=0

```

This listing was produced using a special formatter which breaks one program line over several lines of listing. When entering a line don't press Return until you come to the next line number. Full details of the formatter are in the July issue of The Micro User.

```

  :PLRGZ=10
  :MHZ=2
130 PROCINIT
140 FOR NZ=0 TO 3
  :VDU 19,NZ,0,0,0,0
  :NEXT
  :PROCSCREEN
  :IF TPZ>0TPZ=TPZ-1
  :DELZ=DELZ-1
  :PROCDEL
150 IF MIAZPROCMI
160 PROCSCO
  :IF MIAZPROCMI
170 PROCTM
  :PROCMI
  :IF PRZPROCPRM
  ELSE PROCDELAY(3)
180 IF COZGOTO 530
  ELSE IF QZ=0GOTO 230
  ELSE IF PRESZ=0GOTO 280
190 IF LIGZ<>0LIGZ=LIGZ-1
  :IF LIGZ=0PROCWINDOW(-1)
200 IF INKEY (-74)T=TIME
  :REPEAT UNTIL TIME =T+30
  :REPEAT UNTIL INKEY (-74)
210 GOTO 150
220 DEF PROCPLSET
  :MIAZ=0
  :RPZ=1200
  :RPZ=500
  :ENDPROC
230 VDU 4
  :CLS
  :IF DELZ/TPZ<0.6GOTO 260
  ELSE PRINT TAB(6,10);"A successfu
  l delivery run !"
240 PRINT "TAB(5);"Bonus points
  100 x ";PRDESZ;" = ";100*PRDESZ
  :SCZ=SCZ+100*PRDESZ
  :BAPRESZ=BAPRESZ-1*(BAPRESZ=14)
250 PROCTUNE(1)
  :PROCDELAY(200)
  :CLS
  :VDU 5
  :GOTO 130
260 PRINT TAB(7,10);"Hard luck chum
  - you waste"TAB(7);"almost
  as many presents as"TAB(13);
  "you deliver !"

```

```

270 PROCTUNE(2)
  :PROCDELAY(100)
  :GOTO 530
280 VDU 4
  :PRINT TAB(8,10);"Idiot - you've
  run out of"TAB(14);"presents"
  :GOTO 270
290 DEF PROCSCO
  :GCOL 0,0
  :MOVE XZ,YZ
  :VDU 226,227,228
  :XZ=XZ+16*(INKEY (-98))-16*(
  INKEY (-67))-16*(XZ<0)+16*(XZ>994
  )
  :YZ=YZ-16*(INKEY (-73))+16*(
  INKEY (-105))+16*(YZ>800)-16*(YZ<
  400)
  :MOVE XZ,YZ
  :GCOL 0,2
  :VDU 226,227,228
  :IF INKEY (-99)AND PRZ=0PROCPRDR
300 ENDPROC
310 DEF PROCPRDR
  :PRZ=-1
  :PRX=XZ+36
  :PRY=YZ-32
  :SOUND &11,1,255,25
  :ENDPROC
320 DEF PROCPRM
  :MOVE PRX,PRY
  :VDU 18,0,0,224,8,225
  :PRY=PRY-16
  :MOVE PRX,PRY
  :VDU 18,0,1,224,8,18,0,3,225
  :POZ=POINT(PRXX,PRYZ-36)
  :POZ=POINT(PRXX+32,PRYZ-36)
  :IF POZ<>0OR POZ<>0GOTO 330
  ELSE ENDPROC
330 MOVE PRX,PRY
  :VDU 18,0,0,224,8,225
  :PRZ=0
  :PROCPRZ
  :IF PRYZ>300DELZ=DELZ-1
  :PROCDEL
  :ENDPROC
  ELSE IF POZ=1AND POZ=1AND HOZ(
  INT (PRXZ/210))<4AND HOZ(
  INT (PRXZ/210))<>0SOUND 3,2
  ,100,1
  :PROCDEL
  :PROCSCORE(100)
  :PROCPRND(PRXX)
  :ENDPROC
340 PROCWINDOW(PRXX)
  :DELZ=DELZ-1

```



# SENTINEL

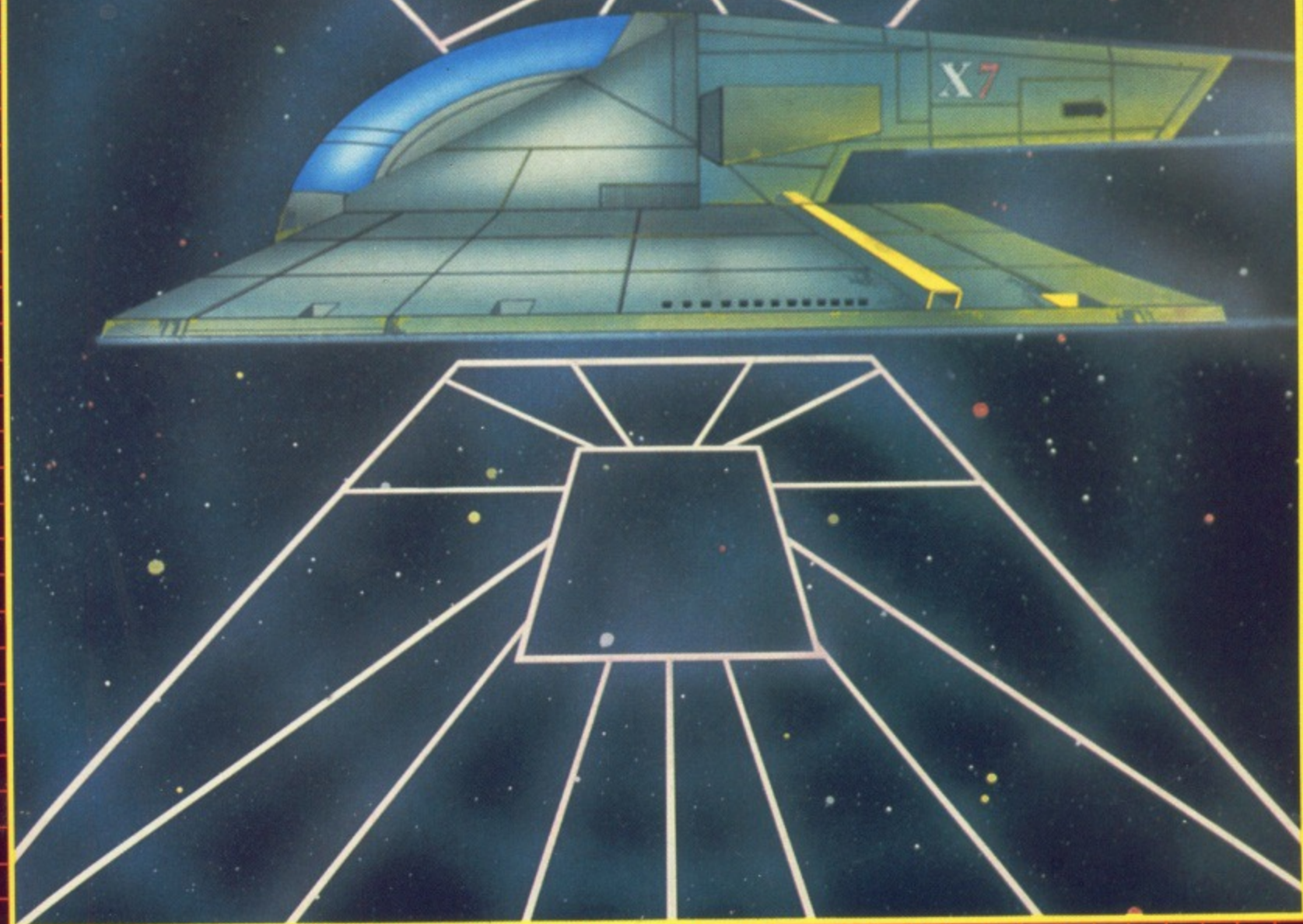

## ARCADE ACTION FOR THE BBC MICRO 32K



### SENTINEL

In a far quadrant of space are the single dimension gateways to the anti-matter world of Migon.

You must stop the constant bombardment of anti matter plasm bolts and meteors in sectors 1 and 2 and the probe vessel in sector 3.

It will be a constant race as the network of laser walls dissolve and they escape into free space.

**6-95**

### CENTIPEDE

You are caught in a vicious jungle of giant insects. Centipedes are attacking you from all sides. Killer fleas are dropping from the sky, and to top things off there's a venomous spider lurking in the background. You only have your trusty laser cannon as defense.

**6-95**

### INVADERS

A superb example of this truly classic arcade game. Includes all the features of the original and much, much more.

**6-95**

SEND CHEQUE OR P.O. TO P.S.S. 452 STONEY STANTON RD. COVENTRY CV6 5DG. FOR INSTANT CREDIT CARD SALES TEL (0203)667556, TRADE ENQUIRIES JOHN FLETCHER, (0203) 81346





# DLT's MONSTER CHALLENGE

## USE YOUR NOGGIN AND WIN £10,000.

You might think you're a computer games wizard . . . I'm pretty good myself. But I've got news for you! I've discovered a second generation of computer games - and they're mind-benders. So if you're a spuddler you might as well turn the page now.

## BECAUSE YOU WON'T STAND A CHANCE IN MY TEN-GRAND-SLAM.

If you can cope with a real challenge, try one of my suite of mind-stretching games. If you're really confident buy all six - it's cheaper.

All the games are independent puzzles but each has a clue. Unravel the clues and put them together to solve the riddle.

The first 10 who can will be finalists in my **TEN-GRAND-SLAM** to win a cool £10,000.

You'll have to be an all-rounder because some of the games will test your intellect, some your general knowledge and one your skill with computers. But they're all fun and I guarantee you've never seen anything like them before.

Games like:

- A. Take the Strain - armed only with a compass and a map of Britain's railways, you must end up at the right section with a valid ticket.
- B. Air/Sea Missile - taxes not only your usual video skills, but also your mind. Bomb the enemy fleet through thick cloud and shoot down missiles before they shoot you down.
- C. Cambridge - take a trip around the city, punt on the Cam, stave off the pangs of hunger and try to reach your destination.
- D. Othello - test your powers of logic with this ancient game, playing against each other or against the computer.
- E. The Tower - escape from the perils of the tower and obtain the keys to escape from the dungeon.
- F. The Quiz - test your knowledge of Britain, playing against each other or the computer in a battle to beat the clock.

TEN-GRAND-SLAM entry instructions will be enclosed with every game purchased.

All Games are suitable for BBC, Dragon and Sinclair home computers.



**TO: TWIG SYSTEMS SOFTWARE, 6 HIGH STREET, WENDOVER, BUCKS. ENGLAND.**

My Name is: .....

My Address: .....

I own a computer Make .....

Model .....

Cheque  P.O.  Access  Barclaycard

Access/Barclaycard No.

I wish to purchase the following cassettes  
Prices quoted are inclusive of VAT.

- A. Take the Strain .....
- B. Air Sea Missile £9.00 each .....
- C. Cambridge or .....
- D. Othello £45.00 for .....
- E. The Tower the set .....
- F. The Quiz .....
- Post and Packing 1.00

I enclose my total remittance of £ .....



## Santa's Saucer listing

From Page 136

```

:PROCDEL
:ENDPROC
350 DEF PROCINIT
:MM%=MM%+1
:LI6%=0
:LI62%=0
:MIA%=-1
:PRES%=BAPRES%
:X%=0
:Y%=424
:PR%=0
:YS%=10
:XS%=30
:PROCMISSET
:PRDES%=0
:FOR NX=0TO 4
:HOX(NX)=RND(3)
:PRDES%=PRDES%+HOX(NX)
:NEXT
:Q%=PRDES%
:MILOC%=MILOC%-1-10*(MILOC%=-1)
:PLRG%=PLRG%-1-1*(PLRG%=5)
360 IF MILOC%=0MILOC%=1
370 ENDPROC
380 DEF PROCMISSET
:MIA%=-1
:MIX%=1170+XS%
:MI2%=254+YS%
:MI3%=1170
:MI4%=254
:MIS%=XS%
:MIS2%=YS%
:MILOC2%=RND(MILOC%)
:IF MILOC2%=MI4%=MI2%
390 ENDPROC
400 DEF PROCDELAY(X)
:TIME =0
:REPEAT UNTIL TIME =X
:ENDPROC
410 DEF PROCHOUSE(X,Y)
:MOVE X,Y
:GCOL 0,2
:DRAW X,Y+100
:PLOT 85,X+200,Y
:PLDT 85,X+200,Y+100
:GCOL 0,3
:DRAW X+100,Y+150
:PLOT 85,X,Y+100
:CH=RND(2)-2
:CH=-25*(CH)-125*(CH=0)
:GCOL 1,1
:MOVE X+CH,Y+100
:DRAW X+CH,Y+150
:PLOT 85,X+CH+50,Y+100
:GCOL 0,0
:DRAW X+50,Y+82
:PLOT 85,X+82,Y+50
:PLOT 85,X+82,Y+82
:GCOL 0,0
:MOVE X,Y+32
:PRINT ;HOX(X/210)
:ENDPROC
430 DEF PROCSCREEN
:FOR NX=0TO 840STEP 210
:PROCHOUSE(NX,0)
:NEXT
440 GCOL 0,1
:FOR NX=200TO 208STEP 4
:MOVE 1120,NX
:DRAW 1280,NX
:NEXT
:MOVE 1152,264
:VDU 229,230,233,234,10,8,8
,8,8,231,232,235,236
450 PROCTM
:COLOUR 1
:VDU 4
:PRINT "Presents : ";PRES%
:PRINT "Score : ";SC%
:PRINT TAB(17,1);"%age delivered
: 100"
:MOVE 0,896
:DRAW 1280,896
:MOVE 512,1008
:DRAW 512,944
:DRAW 1248,944
:DRAW 1248,1008
:DRAW 512,1008
460 VDU 5,19,1,7,0,0,0,19,3,1,0
,0,0,19,2,6,0,0,0
:ENDPROC
470 DEF PROCTM
:IF NOT MIA%ENDPROC
ELSE MOVE 1170,254
:GCOL 0,0
:PLOT 1,XS%,YS%
:YS%=RND(10)+3
:XS%=-140-YS%
:GCOL 0,1
:MOVE 1170,254
:PLOT 1,XS%,YS%
:ENDPROC
480 DEF PROCHI
:IF NOT MIA%GOTO 610
ELSE IF MILOC2%=16GOTO 730
490 GCOL 0,0
:MOVE MI2%,MI2%
:DRAW MI3%,MI4%
:MI2%=MI2%+MIS%
:MI3%=MI3%+MIS%
:MI2%=MI2%+MIS2%
:MI4%=MI4%+MIS2%
500 MOVE MI2%,MI2%
:GCOL 0,1
:PMX%=POINT(MI2%-4,MI2%+4)
:IF PMX%=0DRAW MI3%,MI4%
:ENDPROC
ELSE IF PMX%=-1AND RND(PLRG%)=1
PROCLSET
:ENDPROC
ELSE IF PMX%=-1SOUND 0,3,6,1
:PROCMISSET
:ENDPROC
ELSE IF PMX%<>26GOTO 600
510 GCOL 0,0
:MOVE X%,Y%
:VDU 226,227,228
:FOR NZ=0TO 5
:SOUND &10,2,4,1
:FOR NZ=1TO 3
:GCOL 0,NZ
:MOVE X%+NZ*4,Y%+NZ*4
:VDU 237,238,239
:GCOL 0,0
:MOVE X%+NZ*4,Y%+NZ*4
:VDU 237,238,239
:NEXT
:NEXT
520 VDU 4
:PRINT TAB(10,10);"Failure !!
The end of"TAB(10);"Christmas
as we know it"
:CO%=TRUE
:PROCTUNE(2)
:PROCDELAY(100)
:VDU 21
:ENDPROC
530 VDU 6,22,7,23;8202;0;0;0;0;
:IF SC%>HI2(4,0)GOTO 570
540 CLS
:FOR NZ=0TO 1
:VDU 129,157,135,141
:PRINT TAB(10,NZ);"*** ** Top
5 ** **"
:NEXT
:PRINT TAB(8);"Name Score
%age"
:FOR NZ=0TO 4
:PRINT TAB(8,NZ*2+5);NZ+1;";HI$
(NZ);TAB(18,NZ*2+5);HI2(NZ,0);
TAB(25,NZ*2+5);HI2(NZ,1)
:NEXT

```



## TOP QUALITY PRINTERS! ROCK BOTTOM PRICES!

EPSON RX80	£248 + VAT	EPSON FX100	£458 + VAT
EPSON RX80F/T	£268 + VAT	SHINWA CP80	£228 + VAT
EPSON FX80	£358 + VAT	STAR 510	£238 + VAT
EPSON MX100	£398 + VAT	STAR 515	£268 + VAT

We also have large stocks of sundries including ribbons, fanfold and roll paper, continuous labels, dust covers, etc.

For **FREE BROCHURE** and **DISCOUNT ORDER FORM** write now to:

**Datatech Ltd (TMU)**  
8 Bellingham Close, Bury,  
Lancs. BL8 2TU.

## S.P. ELECTRONICS

ALL IN  
STOCK

BBC  
SPECIALISTS

Acorn Electron	£199
BBC Model B 1.2 O.S	£399
Upgrade Kits A to B	£60
Disc Operating System	£85
Disc Drives	from £212
Disc Operating System D/Density	£91.00
G3WHO RTTY PROGRAM	£7.50
Circuit board for RTTY decoder (inc. instructions)	£6.30
CP80 and Star 510 Printers (inc. cable)	£299.00
Joysticks (pair) self centering + analogue	from £16.00
Printer Cable (Centronics)	£12.90
Speech Synthesis	£55.00
VIEW Word Processor	£59.00
WORDWISE Word Processor	£39.00

Wide selection of software, books, leads, plugs, etc.

SAE for full list. All available Mail Order

48 Linby Road, Hucknall,  
Notts. NG15 7TS.

Tel: 0602 640377

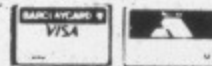

(all prices include VAT)

All prices apply  
while stocks last.

Carriage  
extra

## BBC MICRO CONSOLES

Not just a monitor/tv stand but an expansion console which gives your micro the professional look. Protects and encloses your micro with room for disc drives and 2nd. processor or teletext adapter etc., all untidy connecting wires safely out of sight within the console. Made of light yet strong aluminium with a textured finish in matching BBC colour. Coming soon a bolt on extra module to the console for further expansion options. YES this console will grow with your needs. Basic BBC console as shown **£39.99** + £4 carriage MAIL ORDER ONLY. Viewing by appointment only.

Please add 15% VAT.

For further information  
or send cheque to:

**Silent  
COMPUTERS**

\* The console will  
house the  
Torch Disc Pack

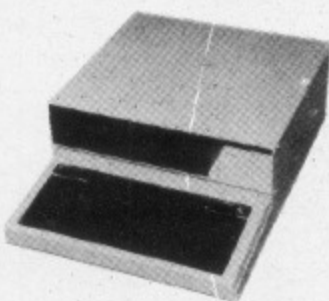

Matching Printer Stand, can  
double for VDU Stand over the  
micro - only **£14.99** + £2 carriage

27 WYCOMBE ROAD, LONDON N17 9XN.  
TEL: 01-801 3014 (24 Hr Ansaphone)

## ★ December 25th, 26th .....

For lasting appeal over the Christmas holidays why not escape with your children and experience one of 4MAT'S marvellous adventure programs, especially written for young adventurers.

**GRANNY'S GARDEN.** An exciting 2 stage adventure/project for young children who have to rescue the Royal children from the wicked witch. Colourful graphics, double-height text and plenty of surprises. For groups or individuals. Ages 6+ (cassette) **£10.**

**SPACEX.** The first Space simulation for children. As scientists stranded on the planet Persephone you must outwit the Kleptoes if you are ever to leave. Requires strategic planning, discussions and map work. For groups or individuals. Ages 10+ (cassette) **£10.**

Also available:-

**WORLD GEOGRAPHY.** (cassette) **£10.** **LINES/ANGLES** (cassette) **£5.**

**4MAT** programs are classroom tested, use colour, graphics and sound. Instruction booklets included. Home use recommended. P&P inc. For disc + £2.

BBC  
32K



**EDUCATIONAL SOFTWARE**

LINDEN LEA, ROCK PARK,  
BARNSTAPLE, DEVON EX32 9AQ.

## 'KILLA' THE UPGRADE

by S.D. Ellington From: BIT TWIDDLERS

If you **already own** the popular game of Killer Gorilla for the BBC Micro then 'Killa' will provide:

1. 15 levels of play.
2. Variable extended jump.
3. Climb and jump with hammer.
4. Extra lives after 25, 50 & 75 metres.
5. Practice mode.
6. Pause facility.

Start practice session at 'any height', 'any level'. Exercise your new powers and discover new routes. Have a go at the higher levels with a fighting chance.

Written by a professional programmer.

**£2.50**

+ 45p p&p

Now available on Micronet

**BIT TWIDDLERS**

158 Church End,  
Harlow, Essex,  
CM19 5PF.

## CHRISTMAS WITH THE BEEB

Celebrate this Christmas with your BBC Micro.

Words and music for 10 popular Christmas carols written for the BBC Model B.

Produce your own printout of the words or copy them from the screen and then sing along to the music.

Christmas Carols on Cassette **£6.95** inc. p&p

Send P.O. or cheque to:

**MICROWISE LTD.,**

6, Epping Drive, Melksham, Wilts. SN12 7HN.

## MICROTEST LTD.

18 Normandy Way, Bodmin, Cornwall PL31 1EX.  
DEMONSTRATION ELECTRON & TELETXT ADAPTOR  
NOW IN.

### SLIMLINE DISC DRIVES

Teac FD55A (100k, 40tk)	£195
FD55E (200k, 80tk)	£230
FD55F (400k, 80tk, d/s)	£290
TEC FB501 (100k, 40tk)	£195
TEC FB502 (200k, 80tk)	£230
TEC FB504 (400k, 80tk d/s)	£290

Above prices include all leads, utility disc and manual.

### MONITORS

Sanyo DM8 112CX (25MHz)	£115
Sanyo DM8112 (18 MHz)	£80
Nordmende 1434 (14")	£249
Microvitec Cob 1431 (14")	£280
JVC Med. Res. (14")	£230

### HARDWARE

BBC Model B	£399
Electron	£199
Disc I/F	£90
Speech I/F	£54
A to B upgrade	£90
Stack light pen + game	£28.50
All upgrades fitted free.	

### PRINTERS

CP80	£309
Star DP510	£309
Epson RX80	£305
Epson FX80	£425
New Epson RX80FT	£310
Seikosha GP100A	£215
Computer/printer leads for above	£12

Large software selection including new Educational section.

All prices include VAT - P&P £9 on large items, 50p on software and interface kits.

For the best - phone Microtest 0208 3812

## EBUG

**Monitor/Disc editor for BBC B.**

Simple and practical.

Allows inspection and modification of  
memory and disc.

Fully documented.

**Tape £12.95 incl.**

**Eaglesoft, 11 Eagle St., Ipswich,  
Suffolk IP4 1JA.**



# Make sure your Micro User collection is complete!



**March issue**  
 Beginners: guide to the keyboard. Build your own games paddle. Word processor review. Guide to text colours and graphics. BBC operating system, Part 1. How to avoid cassette loading problems. Deathwatch listing. Upgrade Model A to B at half the shop price. Shapes program. Bingo listing. Sorting routines. Test for function keys in machine code routines. Colour monitors, Part 1.



**April issue**  
 Beginners: simple programming. Impressive graphics with Teletext Mode 7. Common copying errors revealed. How to draw multi-coloured lines. King Kong listing. BBC Operating System, Part 2. Colour monitor review, Part 2. Upgrade Model A to B, Part 2. Finding the ROM's action addresses. Binary code and how to use it. Disc formatter listing. Plus 8-page pullout for Basic programmers.



**May issue**  
 Beginners: string variables. Pelmanism listing. Mode 7 animation, Part 2. Interfacing in the laboratory. How to generate vertical or even inverse text. Graphics course: triangles and rectangles. Build yourself a joystick. The Osbyte routine: full investigation. Air Strike listing. Anagrams listing. Structured programming, Part 1. How to make full use of the BBC's editing function.



**June issue**  
 Beginners: Use of the INPUT statement. Editing course: LIST and LISTO. Structured programming, Part 2. Solve cassette problems. Build your own graphics digitiser. Hidden \*FX calls. Guide to indirection operators. Single key memory display program. Space Pilot listing. Graphics course: text and graphics windows. Nomsim listing. Bring user defined characters to life. Speed chip review.



**July issue**  
 Beginners: loops. Ten Pins listing. Editing course: the PRINT statement. Graphics course: creating sunburst effects. Structured programming, Part 3. How to use the user port to maximum effect. Space Pods listing. Wordwise review. Epson FX80 printer review. The BBC Micro as a sophisticated design tool. Hexadecimal highlights. How to edit with impunity, and fix that break key.

Back numbers are still available at £1.25 (incl. p&p)

ORDER FORM  
 ON PAGE 99

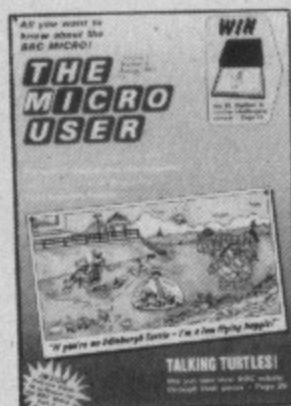

**August issue**  
 Beginners: more help on loops. BBC Micro User's Manchester show reviewed. Animation, Part 1. BBC Buggy and Edinburgh Turtle reviewed. Techniques for switching from tape to disc. Structured programming, Part 4. Inside King Kong: case study of the popular game. Fruities listing. A guide to logical operators. Machine code routines to give Mode 7 colour. Build your own dual cassette system.

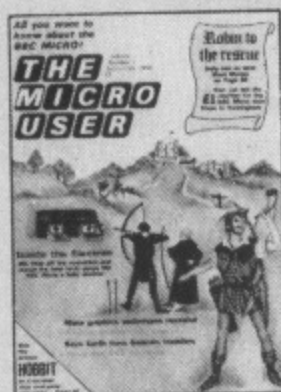

**September issue**  
 Animation Part 2. Editing course: use of TAB. Turn your BBC Micro into a graphics terminal. Galactic Invaders listing. Structured programming, Part 5. Two new DFS and APTL Eprom blower reviewed. Control the outside world safely with your BBC Micro. Robin and Marian listing. Workshop: variable storage explained. Beebcalc investigated. Inside the Electron: Acorn's latest micro reviewed.



**October issue**  
 Graphics: How to draw circles. Fishing. Structure, the last of the series. Format: We update the program. Make a light pen with Body Building Part 8. Editing: Print fields. The Hobbit reviewed. Workshop: Add joysticks to your games. Link Up: Join two BBC Micros. For . . . NEXT loops in Beginners' Part 7. Contour plotting program. Basicode, a computer communications language.



**November issue**  
 Beginners: guide to character codes. Light Pen, more useful software. Forth ROM reviewed. Blackjack, a compulsive simulation of the card game. Putting Basic programs into sideways ROMs. Goblins, a fun packed enchanted journey. Body Building Part 9, projects for the Physics lab. The SOUND command explained, Part 1. Games design: improve your programs.



## Santa's Saucer listing

### From Page 139

```

550 PRINT "*****" Press <SPACE>
    to play again"" or <ESCAPE>
    to see instructions"
:REPEAT PRINT TAB(0,5);CHR$(
RND(7)+128)
:UNTIL INKEY (-99)
:IF VX<>0PROCUNE(0)
560 GOTO 110
570 NX=-1
:REPEAT NX=NX+1
:UNTIL SCZ>HIX(NX,0)
:IF NX=4GOTO 580
ELSE FOR MX=3TO NXSTEP -1
:HI$(MX+1)=HI$(MX)
:HIX(MX+1,0)=HIX(MX,0)
:HIX(MX+1,1)=HIX(MX,1)
:NEXT
580 FOR MX=0TO 1
:PRINT TAB(6,10+MX);
:VDU 129,157,134,141
:PRINT "You are in the top 5
    ";CHR$ 156
:NEXT
:PRINT ""Please enter your name
: - ";
:*FX15,0
590 VDU 31,32
:INPUT A$
:HI$(NX)=LEFT$(A$,7)
:HIX(NX,0)=SCZ
:HIX(NX,1)=INT ((DELZ/TPZ)*100)
:GOTO 540
600 MOVE PRX,PRY
:VDU 18,0,0,224,8,225
:PRX=0
:PROCMISSET
:PROCPREZ
:DELZ=DELZ-1
:PROCDEL
:ENDPROC
610 GCOL 0,0
:MOVE RPX,RP2X
:VDU 240,241,242,243,10,8,8
,8,8,244,245,246
:RPX=RPX-32
:RP2X=RP2X+RND(9)-5+4*(RP2X>YX)-4
*(RP2X<YX)
:GCOL 0,1
:MOVE RPX,RP2X
:VDU 240,241,242,243,10,8,8
,8,8,244,245,246
620 IF POINT(RPX,RP2X-16)=2OR
POINT(RPX,RP2X-28)=2OR POINT(RPX
,RP2X-36)=2OR POINT(RPX,RP2X-48)=
2OR POINT(RPX+48,RP2X-64)=2
OR POINT(RPX+24,RP2X)=2GCOL 0
,0
:MOVE RPX,RP2X
:VDU 240,241,242,243,10,8,8
,8,8,244,245,246
:GOTO 510
630 IF RPX<=0GCOL 0,0
:MOVE RPX,RP2X
:VDU 240,241,242,243,10,8,8
,8,8,244,245,246
:PROCMISSET
640 IF RND(10)=1GOTO 650
ELSE ENDPROC
650 GCOL 0,1
:SOUND &12,VX,40,0
:SOUND &10,VX,3,10
:MOVE RPX,RP2X-32
:PLOT 21,0,RP2X-32
:GCOL 0,0
:PLOT 21,RPX,RP2X-32
:IF YX-32<RP2X-32AND YX>RP2X-32
AND XZ<RPXGOTO 510
660 ENDPROC
670 DEF PROCSCORE(IX)
:VDU 4
:SCZ=SCZ+IX
:PRINT TAB(8,2);SCZ
:VDU 5
:ENDPROC
680 DEF PROCPREZ
:VDU 4
:PREZ=PREZ-1
:PRINT TAB(11,0);PREZ;" "
:VDU 5
:ENDPROC
690 DEF PROCWINDOW(IX)
:GCOL 0,1
:IF IX=-1GCOL 0,0
:IX=LIG2X
ELSE SOUND 3,3,0,1
:LIGX=10
:LIG2X=IX
700 IX=INT (IX/210)
:IX=IX*210
:MOVE IX+50,200
:VDU 248,249,250
:MOVE IX+50,50
:DRAW IX+50,82
:PLOT 85,IX+82,50
:PLOT 85,IX+82,82
:MOVE IX+50,82
:VDU 18,0,0,247
:MOVE IX+50,200
:VDU 248,249,250
:GCOL 0,3
:MOVE IX+200,100
:DRAW IX+100,150
:PLOT 85,IX,100
:ENDPROC
710 DEF PROCDEL
:TPZ=TPZ+1
:VDU 4
:DELZ=DELZ+1
:PRINT TAB(34,1);INT ((DELZ/TPZ)*
100);" "
:VDU 5
:ENDPROC
720 DEF PROCPRNO(IX)
:QX=QX-1
:IX=INT (IX/210)
:HOZ(IX)=HOZ(IX)-1
:GCOL 0,2
:MOVE IX*210,32
:PRINT ;HOZ(IX)+1
:GCOL 0,0
:MOVE IX*210,32
:PRINT ;HOZ(IX)
:MOVE IX*210+HOZ(IX)*50+36,32
:VDU 18,0,1,224,8,18,0,3,225
:ENDPROC
730 GCOL 0,0
:MOVE MI2,MI2X
:DRAW MI3X,MI4X
:MI2=MI2+MI3X
:MI4X=MI4X-MHX*(MI2X<YX)+MHX*(MI2
X>YX)
:MI2X=MI2X-MHX*(MI2X<YX)+MHX*(MI2
X>YX)
:GOTO 500
740 DEF PROCINSTRUCTIONS
750 VDU 22,7,23;B202;0;0;0;0;
:FOR NX=0TO 1
:VDU 129,157,135,141
:PRINT TAB(10,NX);"Santa's Saucer
"
:NEXT
:PRINT "" With the modern day
population,Santa ishard pressed
to deliver to the chimneys"
760 PRINT "of the world,so he has
dispensed with the traditional
reindeer,and hired a saucer
to help with his deliveries."
770 PRINT " The international reindee
r union has formed a action
group to prevent Santa doing
his rounds.Some of them with
homicidal tendencies have

```



PROGRAM POWER MICRO POWER

A SUPERB NEW PROGRAM FROM BRITAIN'S LEADING SOFTWARE HOUSE!

# CYBERTRON MISSION

Fort Cybertron: the most well-protected stronghold in the galaxy. Obliterate the Spinners, Clones and Cyber-Droids as you run from room to room in search of the Fort's riches. Avoid touching the walls with their sizzling high voltage charge. Watch out for the relentless Spook who glides through walls in hot pursuit.

Superb graphical animation and nerve-wrecking sound effects feature in this new machine-code game. **£7.95**

\*VERSIONS AVAILABLE FOR BBC AND ELECTRON



WE STOCK THE BBC MICRO, ELECTRON, DRAGON 32, COMMODORE 64, ORIC AND SPECTRUM.

**SPECIAL OFFER**  
Deduct £1 per cassette when ordering two or more.

All cassettes are fully guaranteed and contain two recordings. All prices inclusive of VAT. Mail Order: Please add 55p per order to cover P & P.

WE'RE EXPANDING!

Showroom: Northwood House North Street Sheepscar Leeds LS7 2AA Tel: (0532) 458800  
Mail order: Dept.BMU12 8/8a Regent Street Chapel Allerton Leeds LS7 4PE Tel: (0532) 683186/696343

WRITTEN ANY PROGRAMS? WE PAY 20% ROYALTIES



The following titles are available for both the BBC Micro and Electron: Killer Gorilla £7.95/ Moonraider £7.95/Bandits at 3 o'Clock £6.95/ Croaker £7.95/Felix in the Factory £7.95/ Felix and the Fruit Monsters £7.95/Chess £7.95/ Escape from Moonbase Alpha £7.95/Draw £9.95/ Swoop £7.95. BBC only (at present): Martian Attack £7.95/Demon Decorator £6.95/ Asteroid Storm £7.95/Laser Command £7.95/ Galactic Commander £7.95/Time Trek £7.95/ Danger! UXB £7.95/Cowboy Shootout £6.95/Wall £5.95/ Alien Swirl £6.95/Labyrinths of LaCoshe £7.95/ Adventure £7.95/Caveman Adventure £6.95/ Filer £9.95/Beebmon £7.95/Barrage £7.95/ Chemistry £6.95/World Geography £6.95/ Where? £6.95/Junior Maths Pack £6.95/ Constellation £6.95/Physics £6.95.

PROGRAM POWER MICRO

BBC MICRO AND ELECTRON PROGRAMS CAN BE OBTAINED FROM SELECTED BRANCHES OF W H SMITH, JOHN MENZIES, BOOTS, HARRODS. ALL GOOD MICRO DEALERS. OR DIRECT FROM MICRO POWER.



# SIMPLY AMAZING!!

400 KByte Storage on a Single  
Microdrive from Computer Village

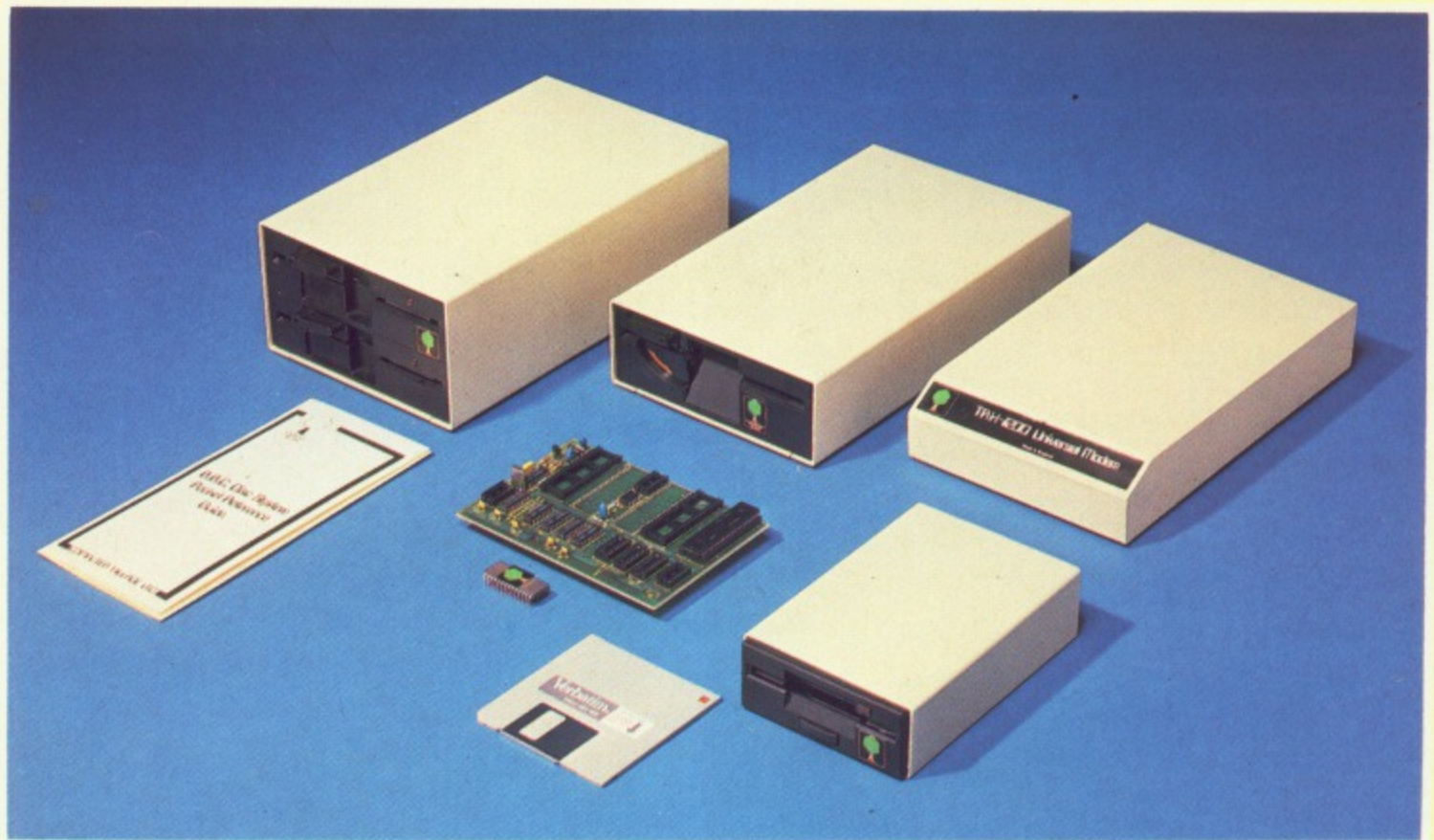

## MICRODRIVES

New international 3½" standard accepting low cost cassette media. Very quiet, very reliable (N.B. unlike some other microdrives capacities quoted are obtained without flipping cassette).

CMD400 Single Drive 400K Byte **£199.00**  
CMD800 Twin Drive 800K Byte **£346.00**

## MINIDRIVES

Superb quality drives including cables, formatter, pocket DFS guide, fully factory tested and aligned before despatch.

**★★ CHRISTMAS OFFER ★★**  
**£19 worth of discs FREE with each Minidrive.**

CA200 Single Drive 200K Byte **£168.00**  
CA400 Twin Drive 400K Byte **£295.00**  
CA800 Single Drive (switchable 40/80 track) 800K Byte **£230.00**  
CA1M6 Twin Drive (switchable 40/80 track) 1M6 Byte **£475.00**

## DISC DOUBLE DENSITY KIT KDD1 £79.00

Professional disc sub-system offering MFM recording, high performance, high reliability disc operation. Compatible with Acorn DFS and Acorn disc based software. No other parts required to convert BBC B to disc operation.

## UNIVERSAL MODEM – TRX1200

Intelligent modem offering software control of transmit/receive modulation, full/half duplex, auto dial. Internal storage of telephone and identification numbers (full networking software available for schools, colleges).

**£86.00 (available November)**

## COMING SOON!! – Please write for details.

For the BBC Micro business user and keen amateur IBC P.C.  
**COMPATIBLE SECOND PROCESSOR**

CVx88 – 8088 processor, 256K byte RAM, CPM86, MSDOS.  
Accepts IBM standard cards.

CVx186 – 8MHz 80186 processor, up to 1MByte RAM, CPM86, MSDOS.

CVx20 – Intelligent graphics processor, IBM expansion card compatible, includes powerful graphics operating system.  
The above processors allow your BBC to run most IBM P.C. software.

**COMPUTER VILLAGE guarantee above products (including drives) for 2 years from date of purchase.**

- We stock prime disc and 3½" cassette media at low prices – please send for list.
- We stock full range of Acorn products and offer full repair facilities at low standard rates.
- Approved LVL/Acorn BBC dealer and repair centre.



Post & Packing  
£4.50 Drives  
£2.50 Other orders

# COMPUTER VILLAGE LTD.

(Mail Order Dept.)

Walker House,  
Telford Town Centre,  
Telford TF3 4HA.  
Shropshire.

Tel: (0952) 506771 General.

Tel: (0952) 506596 Mail Order.

## CHRISTMAS OFFER

5% discount on net price for  
all orders received before  
December 8th.

\* Please add 15% VAT to total order.



A SUPERB B.B.C. PROGRAM FROM BRITAIN'S LEADING SOFTWARE HOUSE!

# ZARM

Weave through the orbiting asteroids to rescue the stranded scout patrol on the inhospitable planet below. Then navigate your shuttle past Zarm's FIVE cunning defence systems using infinite precision to re-dock with the waiting mothership.

Another first-class machine-code game featuring selectable levels, redefinable keys and 'Invisibles' button. ONLY £7.95.

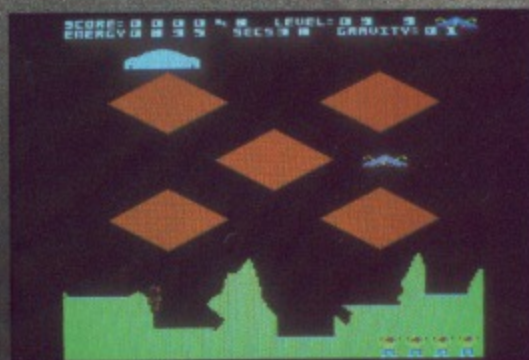

WE STOCK THE BBC MICRO, ELECTRON, DRAGON 32, COMMODORE 64, ORIC AND SPECTRUM.

**SPECIAL OFFER**

Deduct £1 per cassette when ordering two or more.

All cassettes are fully guaranteed and contain two recordings. All prices inclusive of VAT.

Mail Order: Please add 55p per order to cover P & P.

WE'RE EXPANDING!

Showroom: Northwood House North Street Sheepscar Leeds LS7 2AA Tel: (0532) 458800	Mail order: Dept.BMU12 8/8a Regent Street Chapel Allerton Leeds LS7 4PE Tel: (0532) 683186/696343
--	--

WRITTEN ANY PROGRAMS? WE PAY 20% ROYALTIES



WE GUARANTEE THAT ALL OUR ADVERTISED PROGRAMS HAVE BEEN COMPLETED AND ARE READILY AVAILABLE

The following titles are available for both the BBC Micro and Electron: Killer Gorilla £7.95/ Moonraider £7.95/Bandits at 3 o'Clock £6.95/ Croaker £7.95/Felix in the Factory £7.95/ Felix and the Fruit Monsters £7.95/Chess £7.95/ Escape from Moonbase Alpha £7.95/Draw £9.95/ Swoop £7.95/Cybertron Mission £7.95. B.B.C. only (at present): Labyrinths of LaCoshe £7.95/ Martian Attack £7.95/Demon Decorator £6.95/ Asteroid Storm £7.95/Laser Command £7.95/ Galactic Commander £7.95/Cowboy Shootout £6.95/ Danger! UXB £7.95/Timetrek £7.95/Filer £9.95/ Adventure £7.95/Beebmon £7.95/Barrage £7.95/ Alien Swirl £6.95/Caveman Adventure £6.95/ Chemistry £6.95/World Geography £6.95/ Where? £6.95/Junior Maths Pack £6.95/ Constellation £6.95/Physics £6.95.

BBC MICRO AND ELECTRON PROGRAMS CAN BE OBTAINED FROM SELECTED BRANCHES OF W H SMITH, JOHN MENZIES, BOOTS, HARRODS. ALL GOOD MICRO DEALERS, OR DIRECT FROM POWER.



# northern computers

micro computer systems for all applications

we supply, support, and service:

- LISA
- IBM
- Apple II, III.
- Torch
- Acorn Electron
- Acorn Econet
- Fibre-Optic Networks
- Newbrain
- Sinclair
- B.B.C. Computers.

- TRAINING SOFTWARE
- SUPPORT - CAL primary and middle school, graphics design, programming, accounts training packages, professional accounts, e.g. - legal, estate agents etc.

Visitors are invited to evaluate and test LISA, and B.B.C. econet. please contact: GARETH LITTLER or MARK HOWARD

## EDUCATION & TRAINING DIVISION.

Northern Computers, Churchfield Road, FRODSHAM, CHESHIRE WA6 6RD Tel: (0928) 35110



ADMINISTRATIVE SOFTWARE SUPPORT - Timetabling and options, database records and filing packages, word processing, accounts.

## ADVERTISERS INDEX

3D Computers	104	M.W. Systems	10
4MAT	140	Mayfair Micros	150
A.M.S.	3	Merlin	105
Advanced User Guide	73	Michael Bus Systems	128
Aardvark	74	Microage	64, 65
BBC Discount Club	78	Microaid	120
BBC Soft	72	Microbyte	77
Bit Twiddlers	140	Microdraw	104
C-Tech	14	Micropower	152, 62, 143, 145
Cambridge Computer Cons.	119	Microtest	140
Cambridge Computer Store	105	Microvitec	123
CCS	96	Microwise	140
Century Soft	148	Midwich	110, 111
Chalksoft	108	Musicsoft	117
Clares	5	National Magazines	15
Comec	117	National Micro Centres	124, 125
Compusoft	135	Newark Video	130
Computer City	151	Northern Computers	146
Computer Concepts	2, 4	Oakleaf	148
Computer Town	88, 89	OIC	114
Computer Village	144	Optima Software	100
Computerama	11	Opus	44, 68
Contex	109	P&H Electronics	60
Cumana	53	P.S.S.	137
DA Computers	149	Pace	30, 106
DACC	79	Primasoft	120
Datapen	77	Printerland	116
Datatech	140	Qualsoft	41
Dataware	120	Ranlan	148
Davansoft	150	Red Shift	135
Doctor Soft	146	Ricksoft	117, 147
DRG	101	Shards Software	109
Eaglesoft	140	Silent Computers	140
Earlybird	148	Silverlind	108
Economics	27	Simon Hessel	48
Educare	114	Simonsoft	130
Electronequip	76	Sir Computers	70
Epic Soft	150	Softlife	150
Gaisford Soft	148	Softspot	66
Garland	120	Software Invasion	80
Glengary Soft	109	Software Services	148
Golem	114	SP Electronics	140
Graphic Research	82	Stack	71
Griffin & George	90	Superior Software	22
GSL Computing	46	Swift	130
Guildford Computers	86	System	84
H&H Software	17	Tandata	106
H.E.S.	149	Technomatic	12, 13
Hawthorn	47	Tekform	135
Hexagon	128	Torch	20, 21
Ian Copestake	130	Twig	138
IJK Software	126	Twilstar	8, 9
Ikon	16	Viglen	18, 117
Inmac	19	Vision Software	149
Integrex	87	Voltmace	116
J&H Soft	109	Walters Computer Systems	17
John Wiley	42	Watford Electronics	34, 37
Kaydee Soft	102	WD Interfaces	148
Kesparsoft	149		
Kingfisher	149		
Kosmos	128		
Leigh Computer Systems	147		
Level 9 Computing	57, 128		
Longmans	38		

Electron User Advertisers  
A&F 16  
Acornsoft 10, 11  
Master Class 2

## BBC 32K

all operating systems

# 747 FLIGHT SIMULATOR

"THE BEST SIMULATION AROUND,  
A MUST FOR ALL BUDDING PILOTS", PCN

from DOCTOR SOFT,  
258 Coneygree Rd., Peterborough



Pilot written, instruments and 3D visual runway view (Heathrow, Gatwick). Banks and pitches with realistic motion. Now with full Instrument Landing System (ILS). Briefing program, charts, notes and flight plan. Fantastic!

ONLY £8.95 inc. VAT & P&P. Joystick control option in 4 program package.

DISC VERSION NOW AVAILABLE (£11.95)

\* Available from  
JOHN MENZIES AND ALL LEADING DEALERS  
\* Direct mail order  
\* Micronet 800 (Prestel)

DEALERS CONTACT (0903) 206076

GENEROUS ROYALTIES PAID FOR GOOD MATERIAL

### 3 DOUBLE ACTS FOR CHRISTMAS

- Spook, Spook (MUNCHER: 20 mazes, 3 skills, Hall of Fame/GHOST MINE: dig for gold, watch for ghosts & snake) £6.95
- Space, Space (WOOLPACK III: amazing colour graphics, 3 ships, 4 galaxies, aliens galore!/MISSION ALPHA: 3D & music) £7.95
- Spy, Spy (KREMLIN: escape from 3D maze in Kremlin/BONDSKI: lethal action on ski slopes!) £6.95

### GAMES DISC PACKAGE

- Muncher, Ghost Mine, Mission Alpha, Kremlin, Bondski & Fireman (the building burns, the people jump, the helicopter bombs?!) £15.95
- EDUCATIONAL  COLOUR-SHAPE MATCH (2-4 yr old) £5.95 cass.  747 SIMULATOR £8.95  DISC VERSION £11.95
- WORD PERFECT (Friendly & versatile full facility 4080 column word processor. £7.95, + £2.95 Disc version)
- TALKING TABLES TEACHER (Speaks when speech ROM fitted, teaches multiplication with games & questions) £6.95(cassette)
- FAMILY DISC PACKAGE: Tables Teacher, Colour Shape Match, Harmony, Home Office & Word Perfect £15.95

ROYALTIES ... DOC PAYS THE BEST FOR THE BEST!!



**DOCTOR SOFT**  
ADVANCED SOFTWARE



All prices include VAT & P&P Cheque or PO to:  
"Doctor Soft", 258 Coneygree Road, Peterborough PE2 8LR

NAME \_\_\_\_\_  
ADDRESS \_\_\_\_\_

MU12



## Santa's Saucer listing

From Page 142

```

taken to      shooting at Santa
with an AA gun, and he"
780 PRINT "needs help to pilot the
ship while he  makes up the
parcels."
790 PRINT "Move the ship using
:"TAB(20);"Z X"TAB(21);"/
<SPACE> to dropa present ,
and <RETURN> to freeze."
800 PRINT " ** ** Press SPACE BAR
to continue ** **"
:REPEAT UNTIL INKEY (-99)
810 CLS
:PRINT "Input sound level 1=loud"
'TAB(18);"2=medium"TAB(18);
"3=off : ";
:*FX15,0
820 A=BET
:IF A>48AND A<52VDU A

```

```

:A=A-48
ELSE GOTO 820
830 IF A=1V%=-15
:V1%=126
ELSE IF A=2V%=-10
:V1%=80
ELSE V%=0
:V1%=0
840 PRINT " ** ** Press SPACE BAR
to start ** **"
:REPEAT UNTIL INKEY (-99)
:IF V%<>0PROCTUNE(0)
:ENDPROC
ELSE ENDPROC
850 DEF PROCTUNE(I%)
:IF I%=0RESTORE 890
ELSE IF I%=1RESTORE 880

```

```

ELSE IF I%=2RESTORE 900
860 READ L%
:FOR N%=1TO L%
:READ A%,B%
:IF A%=0SOUND 1,0,0,B%
ELSE SOUND 1,V%,A%,B%
870 NEXT
:TIME =0
:REPEAT UNTIL TIME =100
:ENDPROC
880 DATA 5,149,6,157,6,165,6,169
,12,149,24
890 DATA 17,145,4,0,2,145,4,0,2
,145,8,0,2,145,4,0,2,145,4,0
,2,145,8,0,2,145,6,157,6,129
,8,137,3,145,16
900 DATA 7,53,8,37,8,25,8,65,8,57
,4,53,4,57,16
910 IF ERR =17GOTO 80
ELSE MODE 7
:REPORT
:PRINT " at line ";ERL

```

This listing is included in this month's cassette tape offer. See order form on Page 99.

## Leigh Computer Systems

### COMPUTERS

Sinclair 16K	£86.90
Sinclair 48K	£113.00
Dragon 32K	£145.00
Oric 48K	£113.00
Electron	£173.80
BBC 'B'	£346.95

### PRINTERS

Oki Microline	£209.00
Epsom RX80	£225.00
Epson RX80FT	£250.00
Epson FX80	£335.00
Star 510	£225.00
Star 515	£299.00
Shinwa CP80	£225.00
Printer Cable	£8.50

### DISC DRIVES

Single 100K	£165.00
-------------	---------

### EPROMS

Sideways ROM Board	£38.00
2764's (each)	£4.00
27128's (each)	£15.50
(discount on volume)	

### MONITORS

(all complete with lead)

Cabel 14" colour	£190.00
Microvitec 14" colour	£197.00
TV Monitor	£207

### ACCESSORIES

Disc Interface	£78.50
Upgrade A — B	£57.00
Spectrum 16K — 48K	£19.95
Joysticks (analogue)	£15.00
Joysticks (self-centring)	£16.50

LARGE SELECTION OF SOFTWARE  
— TOO MANY TO LIST

£1.25 off 2 pro-rata for over 2  
SAE for lists — state machine

ADD 80p carriage — small items  
£7.00 carriage — large items.  
ADD 15% VAT to total

36 Derby Road, Hinckley, Leicestershire LE10 1QF.  
Telephone: 0455 612139

## DISCOUNT SOFTWARE

FROM  
SOFT SHOP

THIS MONTH'S SPECIAL OFFERS (while stocks last)

	Retail	Our Price (inc. VAT, p&p)
<b>Super-Golf - Squirrel</b> Play golf on your micro. On a superb 18-hole hi-res graphics golf course.	£7.50	£5.99
<b>Atlantis - IJK</b> Contains all the Atlantis/Scramble features. You guide your submarine through the undersea landscape avoiding mines, depth charges serpents etc. Written in machine code to really show off the BBC's superb colour graphics.	7.50	5.99
<b>Creative Graphics - Acornsoft</b> 36 programs to show off the graphics of the BBC Micro.	9.95	8.99
<b>Inheritance - S. Hessel</b> Your great uncle is dead. You must invest wisely in order to get to the second part of the game in which you try to become a millionaire. Great game packed full of features.	5.95	4.79
<b>Word-wise - Computer Concepts</b> Word processor ROM. We think this is the best currently available for the BBC. Too many features to list, good reviews. Details of hiring coming soon.	44.50	37.49

Send for our free catalogue which includes, A&F, Micro Power, Bug Byte, Superior Software, and many more.  
Send catalogue requests and orders to:  
SOFT SHOP, 78 Warren Drive, Hornchurch, Essex RM12 4QX.  
Telephone: (04024 - 47722)



## SOFTWARE BONANZA

50 yes 50 games, educational and utility programs on one tape/disc for your Beeb.

### BONANZA INCLUDES:

**Dr. Who** - a real time graphics adventure using full features of the BBC.  
**Arcade games:** Tron, Zaxxon, Tempest, Laser Command, Meteors and  
**Cots** more Educational programs: 'O' level maths, physics and chemistry, mind games; Mastermind esp and many more.

ALSO MANY GRAPHICS, UTILITY AND MUSIC PROGRAMS ALL ON BONANZA

Bonanza Tape £5.95, Bonanza Disc (state 40 or 80 track) £8.95

ALL TAPES DESPATCHED WITHIN 48 HOURS

Send now for your SOFTWARE BONANZA to:

RANJAN, 3 WENSLEY CLOSE, HARPENDEN, HERTS, AL5 1RZ.

### SUBMARINE SIMULATOR

Navigate your submarine in the Baltic, evade enemy aircraft attack and sink enemy ships, refuel by hijacking a tanker. Features include radar, periscope, instrumentation and chart.

Cassette £9.95 32K

### INVESTMENT

Plots up to five years of monthly data, for up to twelve investments in shares, Gilt Edge or Building Society. Compares interest rates and capital gains. Monthly valuation statement. Save on cassette. Example data for some leading investments given.

Cassette £7.95 32K

### TV ENGINEERS ALIGNMENT AID

Converts BBC micro into TV test signal generator. Colour Bars, convergence grill, purity etc.

Cassette £2.25 16K

Program listings printed by return, confidentiality guaranteed. £2.00.

High quality Daisy Wheel printing. Wordwise format.

30p per page + 30p pp.

GOOD ORIGINAL SOFTWARE REQUIRED FOR THE BBC MICRO  
 40% ROYALTIES PAID.

### ANTHONY GAISFORD SOFTWARE

55 Pebworth Road, Harrow. Middx. HA1 3UE.

Tel: 01-422 4178

## SPRITE WRITER

Throw away your graph paper. Let Sprite Writer take away the tedium of complicated calculations in creating sprites.

Simple to use - full instructions supplied.

All graphics modes. Any of 16 colours available for display in all modes.

Create on enlarged grid. Actual size sprite displayed at same time. Creates data files that can be reloaded for modifying. Also spools data for easy insertion in own program.

Example program included - shows how to move sprites.

Requires 1.2 OS & 32K - ONLY £7.50 incl.

Send cheques and P.O.s to:

### CENTURY SOFTWARE

Dept. MU 100, 60, Borwick Avenue, London E17 6RA.

## EARLY READING PROGRAMS

### Elephant Match

An expertly written and exciting suite of 4 structured games designed to help develop the matching skills essential to reading. Suitable for pre and early readers, these self-pacing games are proving an enjoyable and efficient way of improving reading techniques. Originally developed for use with the handicapped these games are proving even more effective in the home and primary school.

Clear graphics, sound, humorous features, ease of use, and the opportunity to enter your own data, together with a 40 page manual make this an extremely attractive package.

BBC MODEL B ONLY - 2 cassettes + manual £14 inc. P&P  
 Disc version £15 & VAT.



Early Bird, Forge Croft, Cote Lane,  
 Wortley, Sheffield S30 4DN.

Or S.A.E. for further details.

## HARD COPY FOR LESS £'s!

Looking for a printer for listings, program development, etc. Look no further. Now you can use the ZX Printer with your BBC Micro by means of this new interface.

- ★ Built-in mains derived power supply.
- ★ Simply connects to the 1MHz Bus of the BBC Micro and the ZX Printer connector.
- ★ Full upper and lower ASCII characters.
- ★ Supplied complete with relocatable M/C software and full instructions.
- ★ Guaranteed 6 months.

Send cheque or P.O. for £29.95 or s.a.e. for further details.

**£29.95**  
 inc VAT, P&P

Dealer enquiries welcome.  
 Ideal for schools. \*  
 ZX Printers not supplied.

### W.D. INTERFACES

12 Leabank Ave, Garforth, Leeds. LS25 2BL. Tel: Leeds 864328

## SOFTWARE SERVICES

### SECURITY

### ANTI-THEFT DEVICE

#### FOR THE BBC MICRO

YOUR NAME AND ADDRESS DISPLAYED ON SCREEN AT SWITCH ON. CODE WORD MUST BE ENTERED BEFORE MICRO OPERATIONAL. YOUR MACHINE IS THEREFORE USELESS TO A THIEF.

PLUS: You have a PERSONALISED computer.

PLUS: \* SEC. causes a temporary keyboard lockout.

#### INTRODUCTORY PRICE £15

Easily fitted within the unit, no soldering. 1.0 O/S and above.  
 Send name, address, phone no, machine ser. no. and 5 digit code word (letters or numbers) to:

Dept. 1. Software Services, 65 South Mossley Hill Road,  
 Liverpool L19 9BG.

## OAKLEAF COMPUTERS LIMITED

### BBC

MODEL B £399.00\*

100K SINGLE DISK (SHUGART) £228.85\*

100K TWIN DISK (SHUGART) £343.85\*

400K TWIN DISK (SHUGART) £661.25\*

TORCH Z80 PACK £799.00

DISC INTERFACE KIT £70.00

JUKI DAISYWHEEL PRINTER £399.00

"LE BOARD" 16 SLOT RUM BOARD £35.00

DRIVE YOUR BBC-UTILITIES

DIAGNOSTICS AND MANUAL £15.00

PAINTBOX - THE BEST EVER

GRAPHICS CREATOR £9.95

\* PLUS £8 CARRIAGE

BBC  
 SOFTWARE &  
 ASSESSORIES

ALL  
 IN  
 STOCK

NETWORKING  
 & EDUCATION  
 SPECIALISTS



Please send your remittance to:-

121, Dudley Road,  
 Grantham,  
 Lincs.

100, Boughton,  
 OR: Chester,  
 Cheshire.

0476 76994/70281

0244 310099



## B.B.C. ACORN COMPUTERS IN LEICESTER

Specialists in hardware and software.  
Fully authorised ACORN-B.B.C. Dealer  
Complete after sales service - repairs and maintenance contracts.

The four most useful Utilities for the serious B.B.C. User.

### SCREEN DUMP ROM.

This 8K paged ROM will print out any graphics screen (except Mode 7) upright or sideways, x1, x2 or x4 scale on a variety of matrix printers including Epson, Shinwa, Star, N.E.C., Seikosha etc. It will also substitute up to eight shades of grey to represent screen colours. Machine code software to give the fastest print-out possible on your printer. Full documentation provided.

£18.00

### TAPE TO DISC UTILITY DISC

To generate your own disc based version of commercial Basic or Machine Code programs purchased on tape. Detailed documentation explains the various techniques required to perform transfers from even the most difficult tape.

£13.80

### MACHINE CODE MONITOR ROM (LEMON)

Provides powerful facilities for monitoring and debugging machine code and Basic programs. Includes single step, break points, disassembler, memory scan "window", search for string or byte sequence, memory-move etc. Also provides BASIC program search and list variables. Extensive documentation.

£18.00

### ANALYSE DISC

Provides a set of tools for recovering information from damaged or corrupted discs, protecting your own discs or backing-up protected discs. Again we provide all the documentation you need to help you to use the powerful facilities in Analyse and to give you an 'in depth' understanding of the way information is stored on disc by the B.B.C. D.F.S.

£15.00

B.B.C. Model B Microcomputers in stock at £399.00  
Epson FX80 Printers at £419.00  
Epson RX80F/T Printers at £318.00  
Shinwa CP80 Printers at £299.00

Wide range of Books, Software and Accessories for B.B.C. Micro.  
PHARMACISTS - call for a demonstration of our high-speed, comprehensive label printing system.

All our prices INCLUDE VAT - but please add £5.00 postage for any major items.

Please call and visit our showroom at:

**D.A. COMPUTERS LTD.**  
104 London Road, Leicester (2 mins. from Railway Station). Closed Mondays.  
Telephone: (0533) 549407

## ★★ H.E.S. ★★ BBC MICRO HARDWARE (MODEL B)



Load YOUR programs or games from Paged ROM  
16K of software loaded in less than 2 seconds.



EPROM Programmer complete board **£29.99**

\*\*\*\*\*

Will allow you to program 2764 (8k) or 27128 (16k) EPROMS with your own software or games [BASIC or Machine code] in BBC paged ROM format.



Full instructions and software listings to enable your programs to be transferred to EPROM and loaded almost instantly by an operating system command.

★ **H.E.S.** For instant loading

Also: supplied only with EPROM programmer.

Suitable cable for BBC user port £4.99.

Mail Order only from:

**Hemel Electronic Services**  
7 Epping Green, Hemel Hempstead, Herts.



### EDUCATIONAL GAMES for the BBC MICRO from KINGFISHER COMPUTER SERVICES

16 Martock Road, Keynsham, Bristol, BS18 1XA.

Please send SAE for catalogue and details of special offers or send cheque now for immediate dispatch of any of the following:

**MONSTER MAZE.** Have fun finding your way out of the maze but beware of monsters who will ask you to answer an arithmetic question before you pass.  
Age 6+ £7.50 (cassette)

**CATCHAPPLE.** Who said learning multiplication tables was dull? Not with this game - catch the right answer before it drops!  
Age 7+ £7.50 (cassette)

**WORD SPOT.** 3 reading games in one (matching words, opposites and sentences). Carefully graded vocabulary matches the Ladybird Reading Scheme. A supplementary program is available to add hundreds of your own words.  
Age 5+ £9.50 (cassette)

**TREASURE HUNT.** Follow the clues and watch the arrows but mind the traps. Enjoy the search and learn compass points at the same time!  
Age 6+ £7.50 (cassette)

All programs are classroom tested and use clear, colourful and entertaining graphics and sound. Wide choice of difficulty level. Excellent explanatory notes.

## KESPARSOFT

presents

### GYMKHANA

A new game for the BBC Model B. Ride your horses around the show ring but mind you don't fall off. A game of fun for all the family. Various skill levels and speeds.

Send £5 to:

**KESPARSOFT, 22 Pleshey Close,  
Weston-Super-Mare, Avon BS22 9DQ.  
Tel: 0934 22995**

## VISION

### SOFTWARE

★ BBC UTILITY PROGRAMS ★

### COPY FILE II

**COPY FILE II** allows the user to prepare personal backup copies of virtually all BBC micro programs. **£5 incl.**

COPY FILE II is able to backup:-

- **LOCKED** as well as normal programs
  - **FULL SIZE** programs (i.e. up to &6E blocks)
- For use with the BBC model A or B  
Operating system 1.2 - Very simple to use

### DISC EXECUTOR

**DISC EXECUTOR** allows the vast majority of tape based software to be transferred to disc allowing it to be easily run from a menu. (Supplied on Verbatim Datafile discs)

40 tracks **£11 incl.** 80 tracks **£12.50 incl.**

DISC EXECUTOR is designed to handle:-

- LOCKED** as well as normal programs
- MULTIPLE PART** programs
- EVEN FULL SIZE** programs!! (ie. up to &6E blocks)

Up to 10 programs can be saved onto DISC EXECUTOR with your own program title up to 20 characters in length. Very user friendly with no 'systems' knowledge required.

Compatible with Acorn, Watford or Amcom DFS.

NB. Once the disc is full either programs must be deleted or a new disc purchased from us.

Mail order to: VISION SOFTWARE  
1 Allington St., Liverpool L17 7AD.  
and selected retailers.

NB. Users must not infringe any copyrights.





## Eprom Programmer for the BBC Micro

This compact, elegant unit combines the following attractive features:

- high quality, low cost ● easy-to-use 28 pin zero insertion force socket ● free 2764 eprom containing programming software – no cassette loading problems ● menu driven software incorporating the following commands: program, testblank, save, checksum, verify, select eprom
- programs 2764 and 27128 eproms as used on the BBC Model B machine ● built-in voltage converter ● integral cable connects to user port; no other connection needed
- comprehensive documentation plus one year's guarantee

This product is available in quantity **NOW!**

Programmer and data sheet from Softlife Ltd.

87 Silvertown Way, London E16 4AH Tel: 01 474 0330

## TOP SAVINGS ON PRINTERS

### EPSON RX80 – £245

EPSON FX80 – £340

EPSON MX100 – £380

SEIKOSHA GP100A – £175

SEIKOSHA GP250X – £230

OKI M80A – £199

OKI M82A – £319

Prices exclude VAT. Cheque with order.

Excellent Prices also available on a range of Microcomputers, e.g. Sirius, Commodore, Olivetti etc.

PLEASE PHONE FOR DETAILS OR WRITE TO:  
**MAYFAIR MICROS**

65 DUKE STREET, LONDON W1. TEL: 629 2487

## “EPIC ADVENTURES”

FULL-SCALE MACHINE CODE

ADVENTURES FOR THE 32K BBC MICRO

Sophisticated compression techniques provide the longest adventure games available for the BBC Micro, whilst still allowing the use of discs.

- \* Approx. 230 fully described locations \* Colour \* Ultra-fast response \* Scoring \* Fast game-save on tape \* Full-sentence commands accepted \* Each game includes introduction and playing instructions \*

**CASTLE FRANKENSTEIN:** The Frankenstein Monster was thought to have been killed in a fire at the Castle 20 years ago, but a series of unsolved murders has taken place and the people fear that the Monster is on the loose again. Explore the graveyard and Castle ruins, with its secret passages, sulphur pits, etc. to find and destroy the Monster.

**THE QUEST FOR THE HOLY GRAIL:** To become a knight of the round table you must find the Holy Grail and return with it to Camelot. Your search will take you through forest, swamp, castle dungeons and rivers, and on the way you will meet many characters, some friendly some hostile. Can you outwit them all and solve the many puzzles to successfully complete your quest?

**THE KINGDOM OF KLEIN:** The Wicked Witch has stolen the Magic Klein Bottle from its pedestal in the palace. She swore that she would put a hideous curse on anybody who was foolish enough to try to recover it. Your task is to defy the Witch's curse and solve the mystical properties of the 5 solids, in order to kill the Witch and return the Bottle to the Klein Kingdom.

EACH GAME COSTS ONLY £7.95 inc. VAT.  
P&P FREE if ordering 2 or more, otherwise add 50p.

### EPIC SOFTWARE

10 GLADSTONE STREET, KIBWORTH BEAUCHAMP,  
LEICESTER. LE8 0HL.

Please make cheques payable to EPIC SOFTWARE.

Also available on Prestel via Viewfax 258, or see your local dealer.

## QUALITY SOFTWARE FOR THE BEEB from DAVANSOFT

**COMPUTE-A-DRAW** The latest version of our well-known Pools Prediction program by D.S. Peckett. Uses detailed statistical information to predict the likely draws each week. Requires 32K RAM. We don't guarantee that you will win a fortune but ...

Program and instructions £4.95  
Database tape (optional, but holds data on over 7500 matches) £13.50  
Program and DB together £17.50

**DISASSEMBLER** A full-feature 6502 disassembler with automatic labelling and the ability to avoid data areas. 6502 mnemonic and ASCII output. With optional dumps to printer and/or tape for later study, modification and LOADING.

Disassembler £5.95

**SOUND EDITOR** The Beeb's sound facility is very powerful but very complex to use. This cunning program displays, simultaneously, all 18 SOUND and ENVELOPE parameters along with graphs of the pitch and amplitude envelopes. Change any parameter(s) and see and hear the effect immediately. Dumps the result to a printer. Saves hours of typing and experiment; an ideal tool for investigating the system.

Sound Editor (32K only) £5.95

**BBC TURTLEGRAPHICS** A set of PROCedures which add LOGO's amazing turtle to BBC BASIC to give a choice of 2, complementary, graphics systems. Will work in all graphics modes and can support multiple turtles. Complete with demo programs.

TurtleGraphics £5.95

**TAPE-COPY** Worried that you cannot make safety copies of valuable BBC machine-code tapes? This program will back-up any standard format tape, complete with load and start addresses, etc.

Tape-Copy (32K, OS 0.10 only) £7.50

These fully-inclusive prices are for cassette-based programs only. Except where shown, programs will run on any BBC computer.

**DAVANSOFT,**

10 Beverley Crescent, Farnborough, Hants.  
GU14 0BP.



# COMPUTER CITY

THE COMPUTER CAPITAL OF THE NORTH  
78 VICTORIA ROAD, WIDNES, CHESHIRE. 051-420 3333

<b>MISCELLANEOUS</b> Amcom DFS ..... £95.00 Acorn DFS ..... £89.00 L-DOS ..... £90.85 Speech Synthesis ..... £55.00 BBC Joystick ..... £16.95 Quickshot Joystick ..... £19.95 Recorder (with counter) ..... £29.95 Light Pen ..... £27.00 BBC Dust Cover ..... £4.95 Printer Cable ..... £11.00  P&P on Hardware £5.00	<b>ROM SOFTWARE</b> View ..... £59.00 Wordwise ..... £44.85 NEW DiscDoctor ..... £33.85 Beebcalc ..... £39.00 PaceDFS ..... £34.45 <b>MONITORS</b> Microvitec 14" M1431 £247.00 Microvitec 14" M1451 £373.00 Microvitec 14" M1441 £506.00 Cabel 14" ..... £229.00 Sanyo Green ..... £110.00 Electron ..... £199.00 BBC Model B ..... £399.00 BBC Model B/DFS ..... £469	<b>DRIVES</b> (including all cables and manual) PACE Single 100K ..... £212.00 PACE D/S Single 200K ..... £270.00 PACE 40/80 Single 400K ..... £396.00 PACE Twin 100K ..... £388.00 PACE D/S Twin 400K £516.00 PACE 40/80 Twin 800K ..... £700.00 LVL Single 100K ..... £265 LVL Twin 100K ..... £389.00 Torch 280 +64K ..... £	<b>PRINTERS</b> ShinwaCP80 ..... £295.00 StarDP510 ..... £289.00 Seikosha GP100A ..... £219.00 Seikosha250X ..... £270.00 EpsonRX80 ..... £310 Epson RX80F/T ..... £340.00 EpsonFX80 ..... £430.00 Juki6100 ..... £435.00 Smith Corona TP1/E ..... £395.00  <b>NEW</b> JUKI 6100 Daisywheel ..... £459.00
--	---	---	---

**MICRODOWD**

NEW FelixintheFactory ..£7.99  
 NEW Felix and the Fruit  
 Monster ..... £7.99  
 Moonraider(B) ..... £7.99  
 Swoop(B) ..... £7.99  
 AlienDestroyers(B) ..... £7.99  
 Galactic Commander  
 (B) ..... £7.99  
 Timetrek(B) ..... £7.99  
 LaserCommand(B) ..... £7.99  
 AstroNavigator(B) ..... £5.70  
 Constellation(B) ..... £6.85  
 KillerGorilla(B) ..... £7.99  
 Croaker(B) ..... £7.99  
 Chess(B) ..... £7.99  
 Adventure ..... £7.99  
 Painter(B) ..... £6.85  
 CowboyShootout(B) ..... £6.85  
 MoonBaseAlpha ..... £7.99  
 DangerUXB ..... £7.99  
 Draw ..... £10.30  
 Where ..... £6.85  
 Chemistry ..... £6.85  
 WorldGeography ..... £6.85  
 JuniorMathsPack ..... £6.85  
 NEW Hell Driver ..... £7.99

**ACORNSOFT**

Hopper ..... £9.95  
 PhilosophersQuest ..... £9.95  
 SphinxAdventure ..... £9.95  
 CastleofRiddles ..... £9.95  
 Monsters ..... £9.95  
 Snapper ..... £9.95  
 Planetoid ..... £9.95  
 RocketRaid\* ..... £9.95  
 Meteors ..... £9.95  
 Arcadians ..... £9.95  
 SuperInvaders ..... £9.95  
 MissileBase ..... £9.95  
 StarshipCommand ..... £9.95  
 Countdown/Doom ..... £9.95  
 Snooker ..... £9.95  
 NumberBalance ..... £9.95  
 WorldSequencing ..... £9.95  
 WordHunt ..... £9.95  
 MissingSigns ..... £9.95  
 Jars ..... £9.95  
 Sentence Sequencing ..... £9.95  
 LispCassette\* ..... £16.85  
 ForthCassett ..... £16.85

**SUPERIOR SOFTWARE**

Galaxians ..... £7.95  
 Centipede ..... £7.95  
 Invaders ..... £7.95  
 SpaceFighter ..... £7.95  
 AlienDropout ..... £7.95  
 FruitMachine ..... £7.95  
 Rogger ..... £7.95  
 RoadRunner ..... £7.95  
 Pontoon ..... £6.95  
 Cribbage ..... £6.95  
**NEW - NEW**  
 Hunchback ..... £7.95  
 ColditzAdventure ..... £7.95  
 Qbert ..... £7.95

**Simon Hessel**

GreatBritain ..... £5.95  
 Inheritance ..... £6.95  
 The World Travel  
 Game ..... £6.95

**QUICKSILVA**

Music Processor ..... £14.95  
 Beeb Art ..... £14.95  
 Protector ..... £7.95  
 Wizard ..... £6.95  
 Mined Out ..... £6.95  
 The Generators ..... £6.95

**VIRGIN**

Space Adventure ..... £7.95  
 Trench ..... £7.95  
 'Owzat ..... £7.95  
 Cheftain ..... £7.95

**LEVEL 9 COMPUTING**

RQForth ..... £15.00  
 RQForthToolKit ..... £10.00

**ULTIMATE ADVENTURES**

Snowball ..... £10.00  
 AdventureQuest ..... £10.00  
 DungeonAdventure ..... £10.00  
 Colossal Adventure ..... £10.00

**H&H**

Star Trek/Candy  
 Floss ..... £6.50  
 Hangman ..... £4.50  
 SuperHangman ..... £4.50  
 Atlantis ..... £7.50  
 Flags ..... £4.50  
 LeapFrog ..... £7.50  
 5-a-Side Soccer ..... £7.50  
 PontoonandPatience ..... £7.50

**H&H SOFTWARE**

Alphabeta ..... £14.50  
 Billiards ..... £8.50  
 Shape&Race ..... £8.50  
 Signals&Magic ..... £5.50  
 EarlyOne ..... £5.50  
 EarlyTwo ..... £6.50  
 EarlyThree ..... £6.50  
 ExtraOne ..... £4.50  
 ExtraTwo ..... £4.50

**SQUIRREL SOFTWARE**

BBC  
 Supergolf ..... £7.50  
 BunFun ..... £6.50

**BBC SOFTWARE**

HomeFinance ..... £10.00  
 Painting ..... £10.00  
 Drawing ..... £10.00  
 GamesofStrategy ..... £10.00  
 FunGames ..... £10.00  
**NEW**  
 WhiteKnight ..... £11.50  
 Dr.WhoAdventure ..... £10.00  
 Canyon ..... £10.00  
 Toolbox ..... £21.00

**CHRISTMAS OFFER**  
 £1 OFF  
 every cassette for  
 orders of 2 or more

**DOCTOR SOFT**  
 ADVANCED SOFTWARE

747FlightSimulator ..... £8.95  
 WolfPackIII ..... £7.95  
 Kremlin ..... £6.95  
 Harmony ..... £7.95  
 TablesTeacher ..... £9.95

**A: R & I SOFTWARE : F**

180 ..... £6.90  
 Painter ..... £8.00  
 Bouncer ..... £8.00  
 ShrinkingProfessor ..... £8.00  
 HorrorCastle ..... £8.00  
 Cyclons ..... £8.00  
 Howzat ..... £8.00

**Kosmos**

The French Mistress  
 LevelA ..... £9.95  
 The French Mistress  
 LevelB ..... £9.95  
 German Master  
 LevelA ..... £9.95  
 German Master  
 LevelB ..... £9.95

**DIGITAL FANTASIA**

**ADVENTURE GAMES FOR THE BBC**

TheGoldenBaton (A/B)  
 TheTimeMachine (A/B)  
 ArrowofDeath(Pt1) (A/B)  
 ArrowofDeath(Pt2) (A/B)  
 EscapefromPulsar7 (B)  
 Circus (B)  
 FeasibilityExperiment (B)  
 TheWizardofAkyrz (B)  
 Perseus&Andromeda (B)  
 TenLittleIndians (B)  
 ALL ADVENTURES ARE  
 £9.95

**BUG-BY-IE SOFTWARE**

BBCDragonQuest ..... £11.50  
 BBCMultifile ..... £15.00  
 SpaceInvaders ..... £7.50  
 Galaxy Wars ..... £7.50  
 CityDefence ..... £7.50  
 Synthesizer ..... £9.50  
 SeaLord ..... £7.50  
 Oblivion ..... £7.50  
 GraphicsPackage ..... £9.50

**GOLEM SOFTWARE**

Educational1 ..... £8.00  
 Educational2 ..... £8.00  
 FunwithWords ..... £8.00  
 Katakombs ..... £8.00

**BEST PRICE IN BRITAIN**

**TURN YOUR BBC INTO A BUSINESS MACHINE WITH A TORCH DISC PAC**  
 £730 + VAT - NOW WITH **FREE SOFTWARE**

PERFECT CALC  
 PERFECT WRITER  
 PERFECT FILER  
 PERFECT SPELLER  
 TORCHNET  
 COMANEX SOFTWARE

Valued at over **£1,000**

**BOOKS FOR THE BBC MICROCOMPUTER**

30HourBasic ..... £5.95  
 Assembly Language Programming  
 for BBC ..... £8.95  
 Advanced User Guide ..... £12.95  
 An Expert Guide ..... £6.95  
 Structured Programming ..... £6.50  
 Using Floppy Discs on BBC ..... £9.95  
 21 Games for the BBC ..... £5.95  
 Creating Adventure Programs  
 on BBC ..... £6.95  
 Advanced Program Techniques ..... £7.95  
 Assembly Language Programming  
 Electron ..... £7.95  
 Acornsoft Forth ..... £7.50  
 Acornsoft Lisp ..... £7.50  
 P&P on Books £1

**CREDIT FACILITIES**  
 Ask about instant credit up to £1,000. Choose the credit to suit you. The deposit is only 10% of the cost of your purchase.

We are credit brokers for Lombard Tricity Finance Ltd. Interest is just 2.25% per month, equivalent to an annual percentage rate of 30.6%. Ask for a written quotation today!

**MAIL ORDER**

Please send me

1. ....  
 2. ....  
 3. ....  
 4. ....  
 5. ....

Postage and packing on software 50p. Phone for hardware delivery rates.

I enclose cheque/P.O. for  
 OR please debit my Access/Barclaycard/Visa\*  
 \* delete as applicable

Card No. .... Expiry date .....

Name .....

Address .....

..... Code .....

Tel No. ....

Dealers Discount Available  
 ACCESS, BARCLAYCARD VISA ORDERS WELCOME ON  
 24HR 051-420 3333  
 COMPUTER CITY Dept F. FREEPOST (No Stamp  
 Required) 78 Victoria Road, Widnes, Cheshire WA8 7RA.

**LARGEST SELECTION OF SOFTWARE IN GREAT BRITAIN  
 COURTESY OF TIGER DISTRIBUTION.  
 OVER 700 LINES OF SOFTWARE FOR ALL LEADING MICROS**



# MARTIAN ATTACK

A SUPERB  
NEW B.B.C.  
PROGRAM  
FROM BRITAIN'S  
LEADING SOFTWARE  
HOUSE!

(B.B.C. MODEL B or 32k MODEL A with VIA)

ONLY £7.95

Command the solitary laser post to defend the domed city against the onslaught of the Zargon fleet. Sweep the skies above the Red Planet, line the alien craft in the centre of the sights and unleash the devastating power of the neutron cannons. Switch on the city's forcefield as a last resort to deflect the barrage of enemy shells. Smooth-scrolling graphics and devastating sound effects feature in an excellent arcade quality machine-code game.

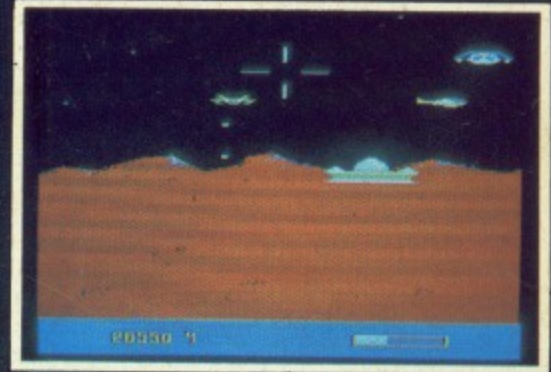

WE STOCK THE BBC MICRO, ELECTRON, DRAGON 32, COMMODORE 64, ORIC AND SPECTRUM.

**SPECIAL OFFER**  
Deduct £1 per cassette when ordering two or more

All cassettes are fully guaranteed and contain two recordings. All prices inclusive of VAT.  
Mail Order: Please add 55p per order to cover P & P.

WRITTEN ANY PROGRAMS? WE PAY 20% ROYALTIES

**WE'RE EXPANDING!**

Showroom: Northwood House North Street Sheepscar Leeds LS7 2AA Tel: (0532) 458800	Mail order: Dept. BMU12 8/8a Regent Street Chapel Allerton Leeds LS7 4PE Tel: (0532) 683186/696343
--	---



The following titles are available for both the BBC Micro and Electron: Killer Gorilla £7.95/ Moonraider £7.95/Bandits at 3 o'Clock £6.95/ Croaker £7.95/Felix in the Factory £7.95/ Felix and the Fruit Monsters £7.95/Chess £7.95/ Escape from Moonbase Alpha £7.95/Draw £9.95/ Swoop £7.95/Cybertron Mission £7.95.  
BBC only (at present): Demon Decorator £6.95/ Galactic Commander £7.95/Time Trek £7.95/ Asteroid Storm £7.95/Laser Command £7.95/ Alien Swirl £6.95/Labyrinths of LaCoshe £7.95/ Filer £9.95/Cowboy Shootout £6.95/Wall £5.95/ Chemistry £6.95/Beebmon £7.95/Barrage £7.95/ Adventure £7.95/Caveman Adventure £6.95/ Danger! UXB £7.95/World Geography £6.95/ Where? £6.95/Junior Maths Pack £6.95/ Constellation £6.95/Physics £6.95.

PROGRAM POWER MICRO

POWER PROGRAMS

PROGRAM POWER MICRO

BBC MICRO AND ELECTRON PROGRAMS CAN BE OBTAINED FROM SELECTED BRANCHES OF W H SMITH JOHN MENZIES, ALL GOOD HARRODS, OR DIRECT FROM MICRO POWER